

# CQ-TV 231



*Streamer Mobile Studio  
gets a rebuild and a hard  
disc recorder*



*QRP  
and  
Buildathon*



*CQ-TV to  
Pay for copy*



*The  
LDK 90  
TV Camera*

*DATV Narrow Band  
Filtering*



*Caption Contest Winner*



*Dicky Howett  
Remembers*

August 2010 - Issue 231

ISSN 1466-6790

www.batc.org.uk

# Versatile On Screen Display Systems



## PIC On Screen Display Project Board

- Fully programmable
  - I/O for sensor interfaces
  - PIC 16F628A micro
  - User definable fonts
- Demo code for GPS display, 1-wire, cash register & MSF



## GPS video overlay units

Display GPS data on any composite video signal

19.2 mph  
11:34:01+01  
-4.2m  
51 30.4503N  
09/28/08  
255.65°  
000 00.4292W



Visit [www.PIC-OSD.com](http://www.PIC-OSD.com)

The BlackBoxCamera™ Company Ltd. sponsors the CQ-TV caption competition. The winner will receive a keyboard text overlay unit with real time clock.



- 4 text pages
- Real time clock
- Counter input
- PS/2 connection
- UK or US key layout
- Colour / mono video
- PAL and NTSC
- Board only option

## Caption Contest

Here are the entries for last issues picture (shown below):

“Did any one remember to remove the lens cap”  
- Mike G6HMG

“No, it is not a lens cap. There is mirror in there that allows the camera operator to quickly switch from looking left to looking right without having to turn himself and the camera 180 degrees around. That way he can see the horses coming and going.”  
- Don Hill, KE6BXT

...and the winner is Don KE6BXT for such an ingenious answer, clearly a lot of thought went into it !! Congratulations, a caption generator will be on its way shortly.

This months photo is below (yes, it's your hon. treasurer), comments please to: [editor@batc.org.uk](mailto:editor@batc.org.uk)



## Contents

Adding a little Black Magic .....	15
Advertising Rates.....	4
AGAF TV-AMATEUR 157.....	33
BATC at the AMSAT Colloquium.....	10
BATC BGM 2010 .....	6
BATC Publications and Members Services.....	36
Camera choice. Vintage or not so vintage? .....	22
Caption Contest.....	2
Circuit Notebook 105 .....	9
Committee Contacts.....	4
Contents .....	3
Contest News .....	34
DATV Narrowband Filtering.....	18
Deadlines.....	4
Digital Upgrade to GB3GW .....	24
Editors Preamble.....	5
HDMI Versions.....	32
How to use the BATC streamer .....	27
Letters to the Editor .....	25
Lincolnshire Steam and Vintage Vehicle Rally .....	30
My 3D Technologies.....	11
QRP & Buildathon.....	21
Remote Infra-Red control of satellite receiver decoders.....	26
Shack Wiring Revisited .....	20
The BATC Presidents, Past and Present.....	35
Turning back the pages.....	37

### Copyright © by the BATC and contributors.

#### Legal Niceties (the small print)

E&OE. Whilst every care is taken in the production of this publication, the editor accepts no legal responsibility for the advice, data and opinions expressed. The BATC neither endorses nor is it responsible for the content of advertisements or the activities of those advertisers. No guarantee of accuracy is implied or given for the material herein. The BATC expressly disclaims all liability to any person in respect of anything and in respect of the consequences of anything done or omitted to be done wholly or partly in reliance upon the whole or any part of this magazine.

As the regulations for the operation of radio frequency equipment vary in different countries, readers are advised to check that building or operating any piece of equipment described in CQ-TV will not contravene the rules that apply in their own country. The contents of this publication are covered by international copyright and must not be reproduced without permission, although an exception is made for not-for-profit publications (only) wishing to reprint short extracts or single articles and then only if acknowledgment is given to CQ-TV.

Apart from any fair dealing for the purposes of published review, private study or research permitted under applicable copyright legislation, no part of this publication may be reproduced, stored in a retrieval system or transmitted in any form or by any means, electronic, mechanical, photocopy, recording or otherwise, without the prior permission of the publisher. All copyrights and trademarks mentioned in this publication are acknowledged and no infringement of the intellectual copyright of others is intended. Printed in Great Britain. ISSN 1466-6790

#### Notice to Contributors

Authors are alone responsible for the content of their articles, including factual and legal accuracy, and opinions expressed by them may not reflect the editorial stance of the publication. Material submitted to CQ-TV should not infringe the copyright of other writers or bodies. Articles remain the copyright of their authors and following publication in CQ-TV, they may also appear on the BATC's web site and CD-ROMs, also in other not-for-profit amateur publications. Contributions are accepted for publication on this basis alone.

# Committee Contacts

**President:** Peter Blakeborough G3PYB  
E-mail: president@batc.org.uk

**Chairman:** Trevor Brown, G8CJS  
Club affairs and Technical queries, especially relating to handbook projects. 14 Stairfoot Close, Adel, Leeds, LS16 8JR. Tel: 01132 670115  
E-mail: chairperson@batc.org.uk

**General Secretary:** Brian Summers, G8GQS  
General club correspondence and business.  
Email: secretary@batc.org.uk

**Hon. Treasurer:** Brian Summers, G8GQS  
Enquiries regarding club finances, donations and constitutional enquiries. 9 Prior Croft Close, Camberley, Surrey, GU15 1DE. Tel: 01276 677879,  
Mobile 077 4029 1191  
Email: treasurer@batc.org.uk

**Membership:** Pat Hellen  
Anything to do with membership, including new applications, queries about new and existing membership, non-receipt of CQ-TV, subscriptions, membership records, etc. The Villa, Plas Panteidal, Aberdyfi, Gwynedd, LL35 0RF, UK. Tel: 01654 767702  
E-mail: memsec@batc.org.uk

**Club Liaison:** Graham Shirville, G3VZV  
Anything of a political nature, co-ordination of ATV Repeater licences. Birdwood, Heath Lane, Aspley Heath, Woburn Sands, MK17 8TN Tel: 01908 282292  
E-mail: g3vzv@amsat.org

**Contests:** Dave Crump, G8GKQ  
Wg Cdr D G Crump, c/o Defence Section, British Embassy Abu Dhabi, BFPO 5413, HA4 6EP, UK.  
Email: contests@batc.org.uk

**CQ-TV:** Chris Smith, G1FEF  
Anything for publication in CQ-TV magazine, except advertising (see below). Email preferred, or by post to: CQ-TV, 89 Wellington Street, Thame, Oxon OX9 3BW  
Tel: 01494 372777  
Email: editor@batc.org.uk

**Members Services:** Chris Smith, G1FEF  
See above for contact details

**CQ-TV Advertising:** Trevor Brown, G8CJS  
14 Stairfoot Close, Adel, Leeds, LS16 8JR.  
Tel: 01132 670115  
Email: adman@batc.org.uk  
Members ads for inclusion in CQ-TV should be sent directly to the editor, either by post or e-mail (see above).

**BATC Webmaster:**  
Anything to do with the BATC web sites  
E-mail: webmaster@batc.org.uk

**Publications:** Paul Marshall  
Handbooks, back copies of CQ-TV and anything related to the supply of BATC publications; Library queries related to the borrowing or donation of written material; Audio & Video archives. Fern House, Church Road, Harby, Nottinghamshire NG23 7ED  
E-mail: publications@batc.org.uk

## Advertising Rates

Size	Mono	Colour
Quarter page	£45	£75
Half page	£90	£125
Full page	£150	£200

**Discounts available for multiple issues.**  
If you would like to advertise in CQ-TV, then please contact our advertising manager: Trevor Brown, 14 Stairfoot Close, Adel, Leeds, LS16 8JR, England. Telephone: +44 (0) 1132 670115.  
Email: adman@batc.org.uk

## Deadlines

CQ-TV is published quarterly in February, May, August and November each year. The deadlines for each issue are as follows: -

February	-	please submit by	December	31st
May	-	please submit by	March	31st
August	-	please submit by	June	30th
November	-	please submit by	September	30th

Please send your contributions in as soon as you can prior to this date. Don't wait for the deadline if you have something to publish as the longer we have your article, the easier it is for us to prepare the page layouts. If you have pictures that you want including in your article, please send them, in the highest possible quality, as separate files. Pictures already embedded in a page are difficult to extract at high quality but if you want to demonstrate your preferred layout, a sample of your finished work with pictures in place is welcomed. Please note the implications of submitting an article which are detailed on the contents page.

# Editors Preamble

Well here it is: CQ-TV231 the August 2010 edition of your magazine on your doorstep in September!

This has been the hardest issue so far for me to put together, I almost had to reduce the page count in order to get it to the printers, there simply isn't enough copy coming from you, the members, for me to put a 40 page magazine together, which is very disheartening.

In the past, I have asked nicely for more copy, and I am grateful to the few people who have made the effort, but it isn't enough, nowhere near enough.

With this problem in mind, your committee have been debating what to do and in the end it came down to two options:

- 1) Cut the number of pages to match the copy I am sent, or;
- 2) Pay for copy as an incentive for you to send copy in for publication.

Most of us agreed that it was worth giving the payment option a try first, so this is how it is going to work:

You send me articles for publication in CQ-TV. After editing BATC will pay £50 for each full page and £25 for each half page, as published in the magazine (not including any pictures printed on the covers).

***Repeater groups - this is most certainly an option for you to do some fund raising for that upgrade to DATV!***

We will only be paying for articles that are deemed relevant and interesting, our initial focus is on constructional articles, in particular homebrew articles for beginners. We may, over time, change the focus and I will of course let you know if this happens.

So for now, we will be happy to pay for articles that will help the newcomer to ATV, in particular homebrew constructional articles, although the decision is mine, so

if someone sends me a particularly well written and interesting article relating to starting out in ATV but not specifically describing a constructional project, I may be persuaded to let the BATC part with some cash!

We have put together some "small print" that clarifies under what circumstances we will pay you, this can be read on page 8, at the end of Trevor's BGM report.

I don't know whether this will provide the incentive for you to send in the copy that the magazine so desperately needs in order to keep it alive, but I think it's worth a try. If it doesn't work, then your next magazine will be thinner, so it's up to you...

Enjoy CQ-TV231

Chris - G1FEF  
editor@batc.org.uk

PS: Please note my new telephone number, for anyone who wishes to call.



We have produced a DVD containing electronic versions of CQ-TV and the CQ-TV articles index. Also included are electronic versions of our three most recent handbooks, 'Slow Scan Television Explained', 'Amateur Television Handbook' and 'An Introduction to Amateur Television' as well as the Lighting eBook.

The archive contains all past issues of CQ-TV and is updated 4 times a year, to include the current issue of CQ-TV.

The DVD is playable in a PC and the data files will 'auto-run' when the DVD is inserted.

The video section was prepared by Brian Kelly and contains videos from Bletchley Park 1999, one from Shuttleworth 2002 and one from 2004. The DVD is available to members for just £5 inc. postage to the UK and EEC. Note that these videos have been made with the H.264 codec and so you will need suitable software to view them.

[http://www.batc.org.uk/club\\_stuff/pubs.html](http://www.batc.org.uk/club_stuff/pubs.html)

Note: This DVD is supplied on +R media only.

# BATC BGM 2010

by Trevor Brown G8CJS

The weekend of the 5th and 6th of June was our second visit to Hellidon lakes, it was my turn at the wheel to organise and using the same venue as the 60th birthday had merit, I had seen the venue and was aware of its limitations and problems. Starting again with another venue was tempting but I am sure there would be other problems that would reveal themselves in the fullness of time.

First we had to re-negotiate the room deal, last time they added a fee to the lecture room hire in order to subsidise the room rates, the internet revealed rooms at our reduced rate were available without any event booking, we stuck out for this at not cost and got into a rather long and complex contract. The meal too they were able to offer at last years rates although nearer the day this became a problem as they added £1,700 to the lecture room invoice for unsold meals, with smoke coming out of my ears I began trolling through the numerous emails with Hellidon and yes they had said in an email this would not happen, fortunately I had kept the email and Hellidon agreed to honour it. They did pull the rug from under us, about two days before by closing the room deal, I know of one person who was refused a room at the deal price, if this happened to you, I am sorry I did my best.

While I was aging rapidly with the hotel, lots of other people came up with help and I am indebted to them, The first was Dave Mann G8ADM who organised a 3G link from his Land Rover to back up the troublesome internet, followed again only days before the event by Charles Denscombe G4HAC, who read about the internet problems of the 60th in CQ-TV contacted me and offered an internet connection via Satellite (Eutel Sat 2). Too good to be true! Charles brought along 1.2 m dish, and set it up behind the hotel from the text reports, this was a major improvement on last year, my thanks to Charles.



**Paul Hundy G7OPD seems to be the chief grips for the event**

Noel Matthews G8TZG took over organising the lecture programme and even though he had to visit the States only a few days before the event still made it, back in time to run the lecture programme, which covered DATV, 3D TV, video Streaming and a lot of in depth information on video compression.

Mike Cox put on a demonstration of 3D TV, Peter Blakeborough G3PYB presented an update on DATV, Dave Mann G8ADM put this into focus with 70cms DATV Yours truly went through



**Noel Matthews G8GTZ in action**

live streaming and making films for the streamer Archive Library, something I am very keen to promote.

The TV cameras were provided by Brian Summers G8GQS, Paul Read, and Bob Robson GW8AGI with a couple of minor outages on Paul's link 125 camera the coverage held together. The streaming kit now has its own dedicated computer and this was its first outing, it has enough steam to record the lectures onto hard drive at a higher resolution than the streamed video, for the film Archive library. This is to replace the DV recordings that up until now have required a loaned video recorders, it is important the streamer kit can stand alone and this is major step towards that end. Another addition to the streamer kit since the RSGB AGM is the now completed cues and talkback box, using XLR connections. The cues diagram is in the last issue. Since then it has been completed and one way talkback to the



**Charles Denscombe G4HAC and the internet uplink dish**

camera's added using a small LM316 audio amplifier and computer head sets. What a difference it makes to be able to talk to cameras and for the camera ops to have cue lights to know when they are on air.

We still have problems to overcome I think the next constructional project will be a video sub switcher, the current mixer has four inputs, one is usually the power point projector and the other three for camera's, but if you want to use the slide generator for holding captions then BNC's need re- plugging, and this is something to avoid, It's hoped to also get the portable studio into a single case so it can be pre-wired to save a lot of grief rigging it every time it goes out.

The suggestions for improving the presentation of events also keep coming in and are invaluable, one was don't put a holding slide up before the start of an event, use live pictures, but superimpose a caption across them to explain the event is starting shortly. This has merit as we lost a few minuetts at the start, the internet was frozen and this was only revealed when we mixed from the start slide to the live event.

Overall it worked, We had 14 people for the dinner, around 30 for the lectures 103 unique visitors to the stream and a peak simultaneous viewing on the stream of 48 viewers,

I would have preferred to see more people in the lecture room despite a personal invite via email to every member, with an email address in the database, thanks to Chris Smith, I am sure that this useful addition to the club software that will find other uses. The software has no filters and generated around 100 replies to be answered , the invites did reach Australia where I got some polite refusals pointing out the 23 hour trip, all taken in good humour.

Dicky Howett was awarded the prestigious Grant Dixon award for his numerous contributions to CQ-TV and his excellent fly on the wall video of the 60th which you can see in the streamer film archive. This I think raises the big question, why so few people on the day? Yes the overnight accommodation was still expensive, but it was free entry on the day, you did not have to stay overnight. and it was centrally located.



**Peter Blakeborough and yours truly giving someone my evil stare**



**Our mobile studio, the new cues box just to the right of the vision mixer, and the new PC and rack case under the table**



**Dicky Howett receiving the Grant Dixon award from the President, Peter Blakeborough**

Perhaps more people would have attended and made a weekend out of it, if it accommodation had been more affordable. Most of the hotels with more reasonable priced accommodation don't have a lecture room (unless you know otherwise), and although 14 people could have eaten together in a restaurant the 28 of the previous year would require private dining. We need something in the middle of the country, good road connections; there has also had a request to make it reachable by public transport. In theory the next BGM is two years away, but if someone has a plan we could have another event next summer. We have in the past had many formula's from the full blown rallies at Sky Blue Connection, or even Crick Post House, anyone remember the 200ft Marquee we put up so as not to turn traders away? In more austere times we have used the Church Hall at Stow-Cum-Quay. It's your club and your event and if you want to see it run again next year then the search is on for a venue and an organiser.....



The BGM Gala dinner putting the world to rights

Off the screen shot from Richard Carden VK4 XRL Brisbane

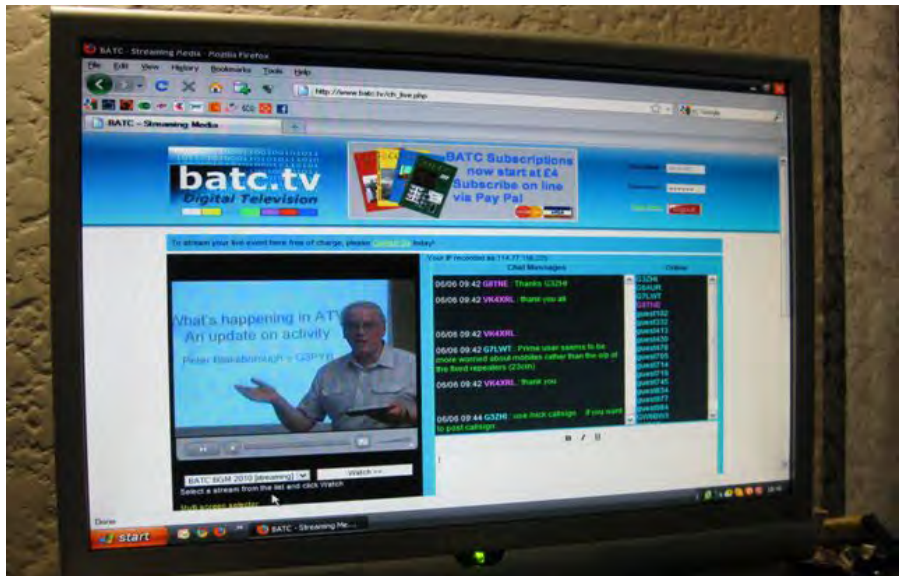

## How to get paid for CQ-TV copy

For the last four magazines we have been short of copy and the task of creating interesting reading is falling more and more on the committee. This is not necessarily wrong, it is one of the things we are here for, but the more we rush around filling the pages at short notice the more we may be concentrating on filling pages and not necessarily writing what you want to read.

The copy we are most short of is good simple constructional articles, so to this end we have allocated Chris a small budget, but enough to pay for 5 or 6 pages in each magazine. This could be a way for repeater groups to get together and design something and finance their repeater.

We have settled for £50 per page as published, and we strongly recommend you email an outline of what you want to submit to Chris for his approval before you start work

The rules are:

- The articles must be related to ATV (editor's discretion)
- They must be something that can be home constructed
- The article must have not previously been published
- Any marketing PCB's programmed chips, or special components will be made available exclusively by the BATC through the BATC shop (unless previously agreed otherwise)
- They will be published at the editor's discretion
- The editor reserves the right to edit any material
- You must own the copyright for the article
- BATC will pay £50 per printed page (£25 per half page) after publication





# Circuit Notebook 105

by John Lawrence GW3JGA

## DTMF Level Tester

In addition to telephone dialling, DTMF (Dual Tone Multi Frequency) control is frequently used for the control of various functions in the amateur radio/TV shack/studio.

It is often used to control several functions in ATV repeaters. My local ATV repeater GB3TM uses a DTMF tone on the input channel for switching between analogue and digital output and for switching to a local test card.

DTMF tones are set into two ranges, a low group 697 to 941 Hz and a high group 1209 to 1633 Hz. This frequency range does not present any problems for the normal audio channel and, generally speaking, DTMF signals are very tolerant to variations in audio signal level. However, if the tone amplitude is too high and audio distortion occurs, particularly after passing through a digital signal chain, then DTMF signalling may refuse to work.

With this in mind, I built a simple DTMF generator, shown in Fig.1. This is essentially a telephone DTMF signaller and an attenuator housed in a separate box. The signaller has a small loudspeaker on the back and would normally be placed over a telephone mouthpiece to provide DTMF facilities for a 'phone which does not have a 'touch-tone' keypad. You may sometimes find these signallers at radio rallies. It is also possible to extract the keypad and dialler from a suitably equipped hand-microphone.

### Circuit

The circuit is shown in Fig.2. No battery switch is required as the dialler only draws current when a key is pressed. The output is taken from across the internal loudspeaker. With a fresh battery the maximum signal level from across the loudspeaker of my signaller was -18dBu (97.5 mV). This signal is taken to a string of resistors which



Fig.1. DTMF Level Tester



Fig.3. Internal view of the DTMF Tester

are wired around a single pole 12 way rotary switch (Maplin N89BX). A 220R pot at the top of the chain allows the -20 dBu output to be set correctly at 77.5 mV. I used a digital multimeter on the 200 mV A.C. range and keyed '1' for the lowest frequencies. The inside of the case is shown in Fig.3.

The level of the output signal will be affected as the battery discharges, but as the drain is only momentary when a button is pressed, many months of operation should only reduce the battery voltage by a small amount. The battery consists of three AA cells which are housed in a black battery box, visible in Fig.3.

### Outputs

Two identical outputs are provided, one through a BNC socket and the other through a phono socket. The output is not buffered, but the output impedance is reasonably low, just a few hundred ohms, so will be suitable for most

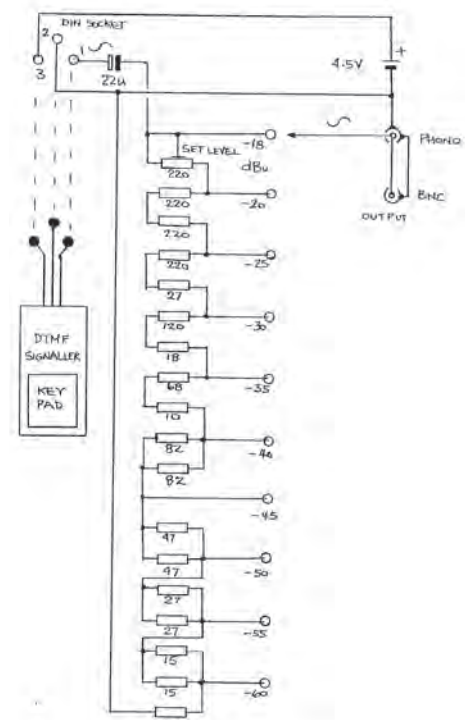

Fig.2. Circuit Diagram

purposes. In my unit, the signaller is connected to the attenuator box using a DIN connector and cable. This is to allow the signaller to be used for other purposes.

### Using the Tester

As an example of its use, I fed the DTMF signal from the tester into the audio input of my 23cms analogue transmitter. I monitored the return signal locally, using an F.M. satellite receiver with an oscilloscope connected across the audio output. I keyed a tone and increased the level until distortion could be heard on the receiver and was visible on the 'scope. I noted the level and reduced this by 10 dB to allow adequate headroom. I then repeated the process by transmitting through the repeater and confirmed a DTMF signal level which was free from distortion by 10 dB through the complete system. This signal level should provide reliable DTMF control and will be used in the future.

# BATC at the AMSAT Colloquium

by *Graham Shirville*

For the third year running BATC were “invited” by AMSAT-UK to provide webstreaming services for their annual Colloquium held at Guildford – usually on the last weekend of July each year. This year we had the benefit of Trevor’s hard work in building a complete desk and recording mechanism into a single, rather large, case. This certainly helped with the initial wiring up task but it really only fits in a hatchback or estate car!

The plan was to do some early rigging on the Friday night (we could not get into the main room until 0700 on the Saturday), go for a meal offsite with the other assembled attendees and to properly start work at the appointed 0700. This part of the plan actually worked well with our President Peter and committee member John Bales both doing great work with three cameras, the projector and sound feeds.

Yours truly was made responsible for the webstreaming part and towards the start time could be seen tearing his hair out as the server appeared not to want to accept a connection from our in built PC. Plan B was rushed into action – feeding the video and audio into a laptop and webstreaming from that. Of course the hotel internet system was not up to the job of streaming the data at 500kb so we resorted to Plan C for this part – a 3G dongle sitting on the production bench alongside all our kit.

This worked amazingly well throughout the weekend and a total of >4 Gb of data was uploaded!

As well as the BATC operators we were greatly assisted by three AMSAT members who joined our team for the event. Ivo Klingert ran the vision mixer as usual, Wouter Weggelaar, also from Holland, operated one of the cameras and Lars Mehnem from Austria the roving audience microphone on John’s long fishing pole.

“Lessons Learnt” were many:  
The rigging always takes longer than you expect;  
If you don’t have every conceivable connector/adaptor/patch cable with you, you will always be missing the vital one;  
Have plenty of back-up plans and spare

hardware for all the kit – including the webstreaming bits;  
The room lighting will always be awful for good pictures;  
The sound will always have buzzing noises due to pickup issue – a number of ground loop isolators will be required on the day;  
You cannot successfully feed line level audio into the mic jack of a laptop;  
Overall it is great fun!

Almost all the presentations were successfully recorded and the results can be seen in the film archive part of the BATC.TV website.

We don’t seem to have many photos of our efforts – we were too busy doing it – but Peter recorded a good introduction to the system which can also be seen in the “Film Archive”.



## !!! Your Club Needs You !!!

If you do something, anything, related to ATV please drop your editor an email so it can appear in CQ-TV, if you can write an article about your latest project even better, you may even get paid !!

**[editor@batc.org.uk](mailto:editor@batc.org.uk)**

# My 3D Technologies

by Mike Cox

This article is based on the talk I gave at the BGM at Hellidon Lakes in June. If you were there, look away now. [Fig. 1] However some work has been done on the playback of 3D recordings, described later.

The idea started when I was asked just over a year ago to investigate a theory for autostereoscopy, which is a long way of saying 3D without glasses. At the time I had a rough idea of what lies behind 3DTV, and there had been some activity at IBC. So I started to look into it, and the idea of building a 3-D TV source took hold. I have told the story of the original camera with Maplin's "pinhole" CCTV cameras in CQ-TV 227, and subsequently in CQ-TV 228 and CQ-TV 230.

I then had a bit of luck when a friend was re-equipping his recording studio with HDV cameras and he sold me 2 of his original Sony Digital 8 cameras. With a bit of metal work, mainly drilling and tapping, the two newish cameras were mounted on the aluminium block, and working with the original CCU. One of the drivers for the project is to use as much re-cycled material as possible.

## Basis of Vision in Depth

So much for the hardware. What is 3D about? Most creatures have two eyes, or they have for the last 500 million years or so. [Fig. 2] The eye-brain complex has evolved so that humans, and presumably other binocular creatures can see depth, and presumably have an idea whether that other creature they see is a small lizard close to, or a large dinosaur rumbling towards them as yet a long way off. So any recreation of stereoscopic vision must start with two imagers. It must also be able to convey images separately to our left and right eyes. Now we have set out the specification, we can get back to the hardware.

## Camera

There was a small snag to start with. Sony, like many camcorder makers use



Fig 1

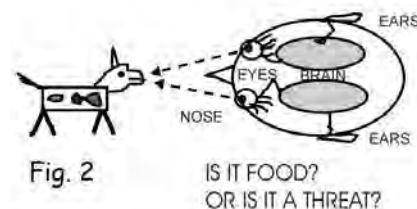

a four pole 3.5 mm jack plug/socket to get composite video and stereo audio out of the camera. However Sony uses a different connection set to the industry standard. This means that standard cables such as you get with a camcorder are no use. Luckily Maplin's sells 4 pole jack plugs. [Fig. 3]

Another snag appeared after running the new camera head. The cameras are designed to operate from 7.2-volt batteries [Sony NP-FM30], or an external supply. Accordingly a 7.5-volt regulator was set up in the CCU. However, while this worked OK with one length of cable, it was useless with a different cable. The regulator [LM317] was moved to the camera head and 12 volts fed down the cable, End of problem. [Fig. 4] One advantage of the Sony cameras is that they are 16:9 capable, and have foldout viewfinders, so a separate viewfinder is no longer needed. At present the two zoom lenses are set to widest angle. One of the comments in the technical press recently has been the problem with zoom lenses not tracking in either zoom or aperture when used with two cameras. One or two lens makers are looking at this carefully and starting to offer lenses that will track at rest, and while zooming. This is not a trivial task.

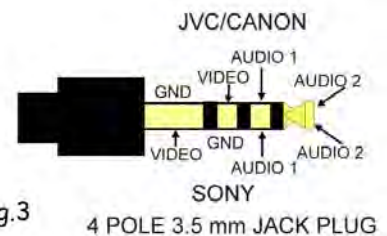

Fig.3

One of the problems with larger cameras is that mounting side by side sets a minimum inter-ocular distance for the rig. As an alternative, mirror rigs are often used where the inter-ocular can go to zero if necessary. Wide inter-ocular can give trapezium distortion, and this and other problems may need to be corrected at the edit. [Figs. 5, 6, 7]

Miranda, JVC and others are offering sophisticated 3D processing equipment that corrects many of these errors in "post", as they say. There is a new crewmember, the "3D puller". No doubt after the World Cup, operational techniques will stabilise somewhat, but now everyone is learning.

## CCU

The original CCU was built on a spare 1U rack unit, but was not too user-friendly. I re-cycled a redundant sawtooth generator built in the 60s, and built the CCU in the case. [Fig. 8]

The experimental video format is field sequential standard definition [SD], such that lines 1 – 312 are from Left camera, and lines 313 – 625 are from Right camera. To achieve this, the camera signals must be synchronous. Luckily, I have a couple of TV One synchronisers.



With a common reference signal, they do an excellent job. They also have video processing capability so that the camera videos can be matched if necessary.

Signals from the synchronisers go through the title inserter section. This is a pair of non-additive mixers, which have proved very successful in adding titles to composite signals. It is essential that the title video be modified with a large blanking pedestal, [Fig.9] or severe sync and burst distortion to the background signal will result. The object of the titler is to investigate graphic insertion in the 3D world.

Although the synchroniser can output a Y/C signal, as can the cameras, to start with, this extra complication was avoided. Signals can go a numbers of ways. There is a direct output from Left and Right channels for the projectors. A CMOS switch [74HC4053] selects Left for Field 1 and Right for field 2, giving the field sequential output, and a difference stage gives a Left – Right output useful for alignment.

The CCU now has a monitoring switch, so that Left, Right, Left – Right or Field Sequential signals can be monitored on a local display.

A recent addition is Edge Blanking. Any objects close to camera may be seen by say the Left camera but not by the Right one. This will give a wrong clue to the eye-brain combination. Accordingly a blanking generator can be switched to blank off left and right edges of frame. [Fig. 10]

### Display

I already had a pair of shuttered glasses from 3D Experience, but they are cabled, which is somewhat limiting. Further, experience has shown that only CRT monitors work with simple field sequential coded 3D. This is because most LCD displays start by de-

Fig. 5

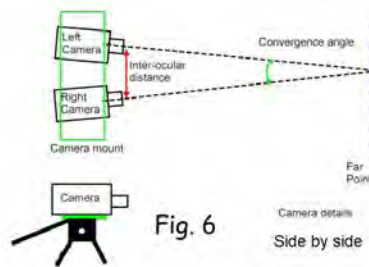
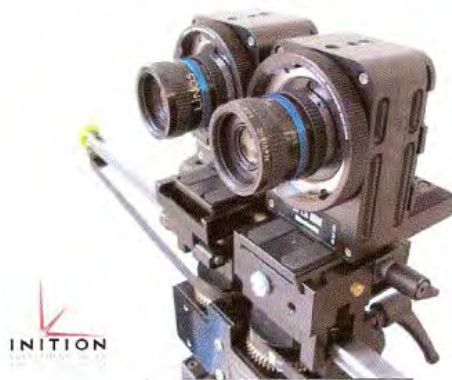

Fig. 6

interlacing incoming video, thus neatly destroying the left-right sequence. Thought was given to other means of separating left and right images, and eventually turned to the use of two projectors. Up to now the project has proceeded using mainly recycled parts, but the decision was taken to lash out on a pair of Acer DLP projectors. As part of the object of the experiment is to gain experience with stereoscopic images, this seemed to be a reasonable outlay. [Cheaper than 10 pairs of shuttered glasses] The two projectors had to be set up with separating filters in front of each lens. The cage that carries the two projectors also had to be configured so that the projected images are congruent. To assist project alignment, a simple test generator was built into the CCU. At the throw of a switch, a greyscale or a grating can replace camera pictures.

The first experiment used Dolby system

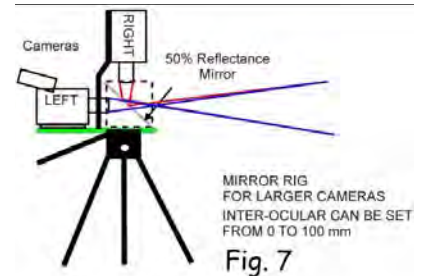
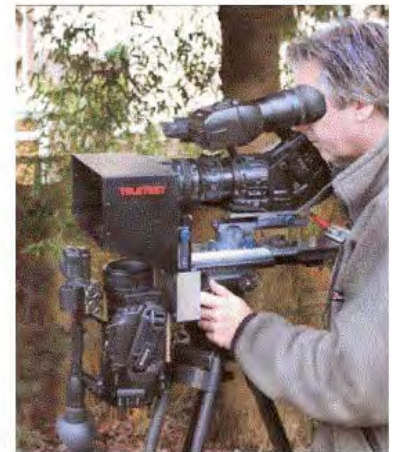

Fig. 7

glasses that I borrowed from the BBFC. [Fig. 11, filter curves] Each lens is arranged with 3 narrow band colour filters, each roughly in the R, G and B parts of the spectrum. The response peaks of the filters are slightly different between Left and Right lenses. Thus separation is achieved. The glasses and filters are quite expensive. However, there are now large quantities of 3D glasses with circular polarising filters available on eBay for a pound or so each. So thoughts turned to this technique. As always, there is a snag.

The Dolby system can be projected on a wall or a screen, whereas the circular polarised system [RealD] requires a “silver” [or aluminised] screen to work properly. [Ref. 1] However through an IBC contact, I was given a damaged 12-foot by 9 foot silver screen. I have cut a 4 foot wide piece off and mounted it on a sheet of MDF.

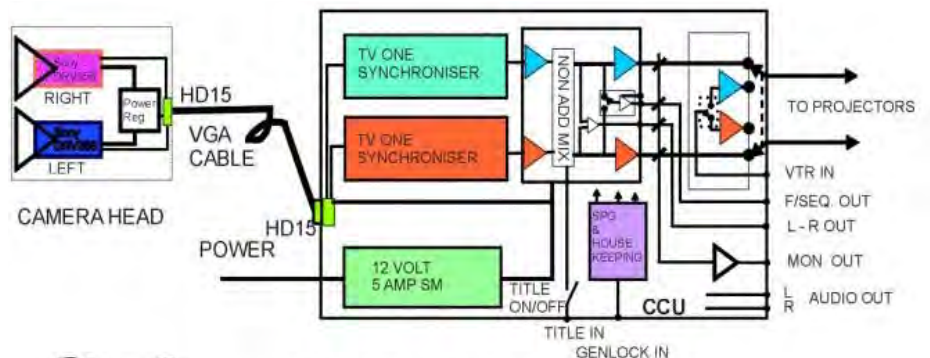
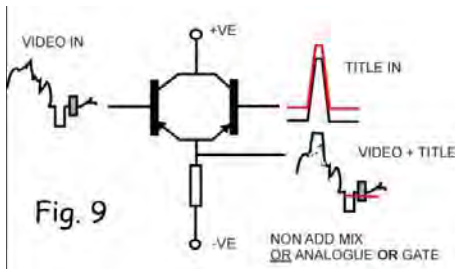

Fig. 8

3D SYSTEM BLOCK DIAGRAM



**Playback Time**

The original experiment was recorded on a DV recorder, so thought was given to replaying the field sequential recording and processing it so that the left and right signals are once again available to feed the projectors. As an experiment, I fed one of the projectors with a signal with normal video for field one and black level for field two. The projected image was reasonable, with only small amount of flicker.

So a card was built to take the playback video from recorder or DVD player. A sync separator provides clamp pulses, and a clean sync feed to lock the CCU SPG when required. Clamped video feeds a switch [74HC4053] that during field 1, provides full video to Left channel, and black level only to Right channel. During field 2, the process is reversed. [Figs. 12, 13] The production of black level is achieved by using blanking as a gating signal. A better way to achieve this will be to have a field store for each channel that is read twice. We lose resolution, but the “frame” rate is restored to 50 Hz. However, with PAL inputs, it involves decoding to YCbCr, and then storing, and recoding to PAL. This work is now in hand and experiments with a monochrome playback prove the principle.

The 3D replay adapter is being based on “Noah”, the aspect ratio converter I described in CQ-TV 214/215 a year or so back. Much of the essential house keeping and ADCs are in that unit, and the 3D adapter is a useful addition. The repeat field process is straightforward; the digital video is fed to an ‘HC574 latch in parallel with the I/O pins of a 4M bit SRAM [AS6C4008]. [Fig.14 shows a field 1 repeat circuit] The Chip Enable pin of the ‘HC574 and the Write/Read pin of the SRAM are fed with a 25 Hz frame square wave from pin 7 of an LM1881 sync separator [part of “Noah”]. The other unit is fed with the complementary frame signal. Left Signal plays from the latch during Field 1 and

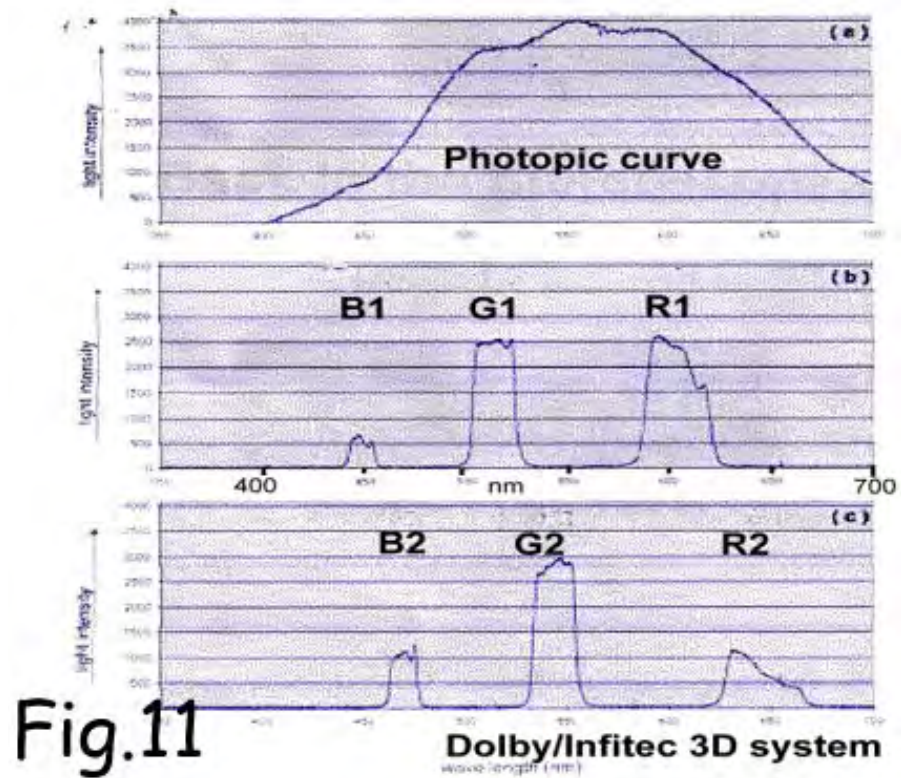

**Fig.11**

from the SRAM during Field 2, and conversely for the right signal. Clock for the latch and the address counter is 13.5 MHz, also from “Noah”.

Analogue video is recovered with a DAC chip connected to the I/O pins, and clocked at 13.5 MHz. The chip used is a DAC908U, capable of operating up

to 100 Mbps, and driving 1volt into 50 ohms. It seems to be widely available. Because we are in the component world, we will need 3 of these combinations for each channel, left and right. [Fig. 15]

The analogue component signals can now be coded to PAL to drive the projectors.

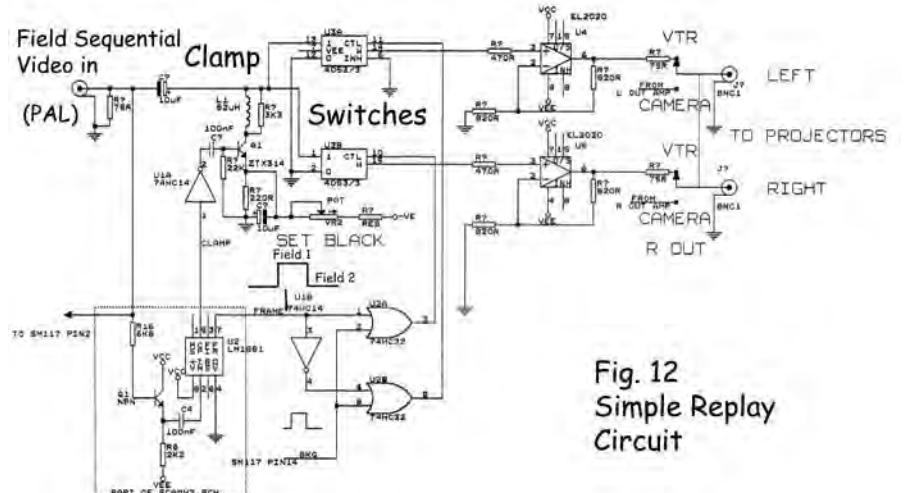

**Fig. 12**  
**Simple Replay Circuit**

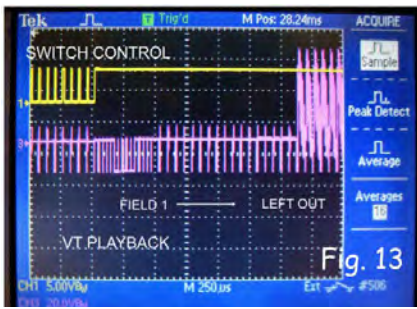

Fig. 13

The plan is to use Sony CXA1229P encoder chips as they require very few additional components, and I have some in the drawer.

The “side by side” method of coding looks to be the broadcast favourite at present [Sky]. We have seen this sort of technique before in Betacam and DMAC. It is based on the principle, as used in “Noah” of writing a signal to a store using one clock frequency, and reading it out with a different frequency. The stretch or expansion is dependent on the ratio of the two clock frequencies. In this case, two to one. [Fig. 16]

**Conclusion**

This has been a very quick canter through some experiments with 3D TV. Meanwhile much work has been going on in various parts of the world producing

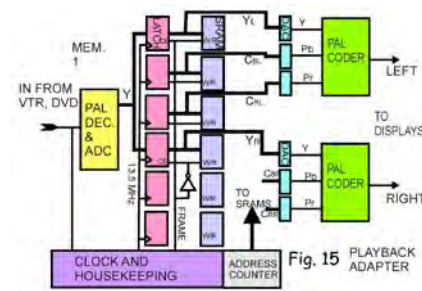

Fig. 15 PLAYBACK ADAPTER

equipment and standardising a working broadcast system [SMPTE]. It is not yet finished although 3D TVs are already on sale in the UK, presumably on the back of the Sky transmissions. People are still looking for the Holy Grail, i.e. 3D without glasses, or autostereoscopy. The shuttered glasses that manufacturers like Samsung and Panasonic are offering are very expensive – about £50 - £60 a pair. [Richer Sounds are offering LG and Samsung glasses at £99.95 a pair!] You only get two pairs with each set. Marshall Electronics have been able

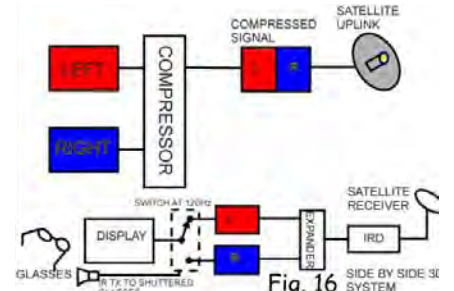

Fig. 16 SIDE BY SIDE SYSTEM

to offer a 24” studio monitor that uses circular polarisers and this is a step in the right direction. Circularly polarised glasses are as cheap as chips. [And not so hard on the waistline] [Figs. 17, 18] This is an ongoing experiment, and I expect I will be returning to it. Thanks to the usual suspects, but principally to my wife, for her patience when things don’t go quite to plan.

**References**

Ref. 1 go to Wikipedia and put in “Silver Screen”

AS6C4008 4 M bit SRAM, sourced from Farnell [www.Farnell.co.uk]

DAC908U 8 bit latched DAC, sourced from RS [www.rswww.com]



Fig. 17

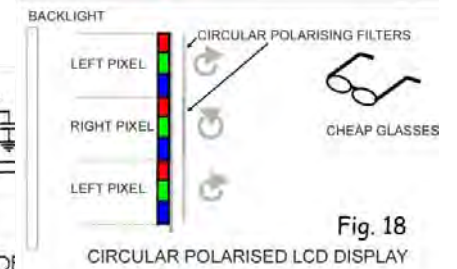

Fig. 18

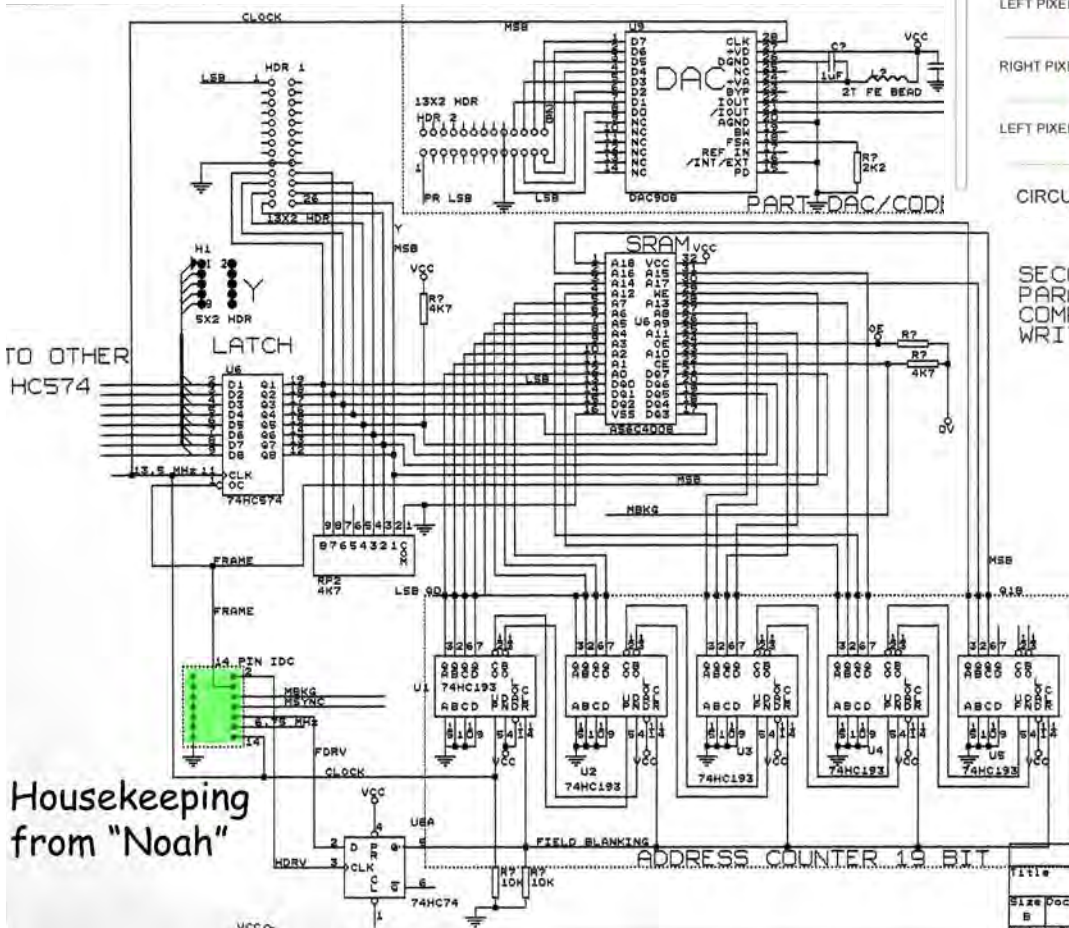

Fig. 14 Part of triple Field Store, x 2

Housekeeping from “Noah”

TITLE	TRIAL OF SRAM UNIT
Size document Number	
B	SRAMCCT2_SCH
Date:	September 4, 2010 Sheet 1 of 1

# Adding a little Black Magic

by Trevor Brown, G8CJS

Intensity pro is small PCI express card from Black Magic that enables sound and video to be digitised and stored on the hard drive of a computer and replayed via that same hardware. So for a modest outlay £116 plus VAT, your computer becomes a digital VTR with HDMI and analogue component, NTSC, PAL and S-Video capture and playback.



[http://www.videoediting-direct.co.uk/\\_product\\_44018/Blackmagic\\_Intensity\\_Pro](http://www.videoediting-direct.co.uk/_product_44018/Blackmagic_Intensity_Pro).

Having bought an intensity pro card and fitted it to the newly acquired club streaming PC so that future lectures can be recorded on hard drive I thought we would give it a road test. It comes with Black Magic's own software for the PC, "Media Express", which is simple and intuitive to drive, this card belongs to a whole range of black magic products which are fast becoming the industry standard for interfacing PC's to the video world. Adobe Premier, Final Cut and numerous video editing software packages interface to these cards.

There are two desk top icons to access the software, one takes you to the set up, where you can preset the standard for record either Pal or Component, add setup if you want Pedestal at 7.5 IRE (USA Standard) or zero for Japan and of course the UK.

The second Icon opens the media express control panel, there are two options in the view menu, full screen and compact. The compact display takes up about two thirds of a 1920 pixel monitor and is a little greedy when you want to share applications with Adobe Live Media encoder and our own internet viewer at [www.batc.tv](http://www.batc.tv), which is essential when streaming so you can see the text and

be aware of any reported problems. The left hand side of the control panel is a file list and not essential when streaming so by positioning the panel at the left of screen and putting the file menu off screen then it takes up just over a quarter of the viewing area

The other drop downs include the edit which has a preference option, for which drive you want to record on and what format. I chose motion jpeg which is 4:2:2 (but not my favourite format as my editor software Newtek Toaster 4.5 won't handle it, I think it did on earlier versions of the software, but I must have paid for a down grade at some point as it will no longer handle this format. When you try to load a format it will not edit, it follows my least loved point of Newtek software logic "on error freeze and crash"; well at least no annoying messages then).

Media Express also has a cue mark drop down that enables you to mark edit points in record and set up a log for help when editing, you lose all these if you push it off screen left, but when streaming marking points of interest is probably a little optimistic, when other things rise to the forefront. And it does free up screen space for other applications

To set it into record just enter a file name and press the capture icon or enter Control R from the keyboard, It has an interesting icon that indicates in red that it is in record and is also equipped with a bar graph audio level meters for both audio tracks (stereo). They continue to indicate audio level even if you click on another application, but if not recording the audio level indicators freeze when you leave the application so don't rely on them if you are not in record. Same for the video screen within the application if you are not in record and leave the application it freezes, (don't get caught out).

The newly acquired club streamer PC has a quad core processor running at 2.2 GHz and equipped with 4 GB of RAM. With the media express recording, the

adobe live streamer running at H264, FLV recording, and logged on to the streamer site to monitor the returning signals, the CPU managed 60% activity so I think we are on top of multi tasking ... could we want it to do any more?

The replay tab is just as simple select a file, press play and off it goes, you can shuttle forwards and backwards, with a time line slider, it really is a dream to use, ideal for running a pre recorded programme across the lunch break, when working on a live event. The only downside is you must not leave the application window or the replay stops, so don't be tempted to start answering text messages on the streamer when replaying an item to the world.

The final tab, Master is interesting, it allows insert and assemble editing, so you could switch off the audio and mark in and out points and insert material into your recordings, might be useful to replace projector shots with clean power point slides, not bad for simple bundled software.....

The card interface is via a short loom, perhaps being a little longer might have been a help and the loom terminates in phono connectors, not my favourite but they are small and well labelled so connection to the card is simple. If you have HDMI sources there are two connectors on the rear of the card so the multi loom is not required. It worked first time and converted the club's new PC into a high quality video recorder and with the falling price of computer hard drives has to be the way forward and takes the batc into the world of tape less video production.



multi screen of the streamer, top left PPM free from Darkwood, top Right Monitoring the streamer, bottom left Media Express, bottom right Adobe live streamer, middle monitoring the CPU activity, if only the graphics would re-size to a smaller format.

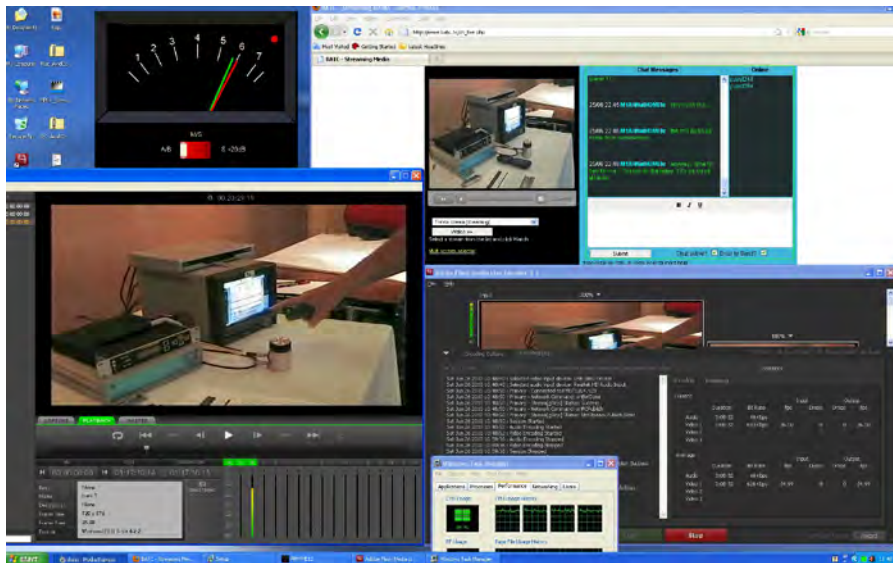

In summary I like the black magic card, annoyed that you cannot leave it playing back and select another window, I suspect it going to be a useful asset to the club, just wish the on screen graphics were not so large, the same for the Adobe Live Encoder.

We did get the CPU to 86% as we put the intensity pro into play back, the

Adobe Live Media encoder to stream at 480 by 576 (500kb/s) H264 and then stream and record an .FLV file (I have a good internet connection at home) pleased we opted for a quad core PC, But then you would not push it quite so hard on site. I think my dreams of a simple multi display are shattered; the picture above was a screen grab from a 24" 1920 by 1200 monitor and I think

double headed monitoring might be the way to go.

### Rebuilding the streamer kit into a modular case

Now we have the computer and the black magic card let's see if we can combine it into something that does not take several hours to rig.

We acquired a second hand 12U Gator 19" rack case, these are perhaps the lightest cases on the market, and 12U is pushing the average car boot, can we fit all the streamer kit into it? There were audio problems during the BGM, in that the daisy chain of audio connections signals did not reach the black magic card, the new prewired rack should ensure this never happens again the phono parallel connected block is central to this audio strategy. There is a Darkwood PPM monitoring the input audio line jack on the PC and thus provides a clear indication that the sound is reaching the phono block, everything connected to this block is via a simple phone lead no adaptors with the exception of the video card which at the moment has a y cord to join left and right inputs this will shortly be replaced with two separate leads direct to the phono block, The audio input of

the PC is connected to this jack socket and audio levels monitored by this on screen PPM (free application from Darkwood)

Also new to the kit is a Maplin video and audio switcher box, somewhat of a relief as I had in mind to construct something to enable input one of the mixer to be switched between camera one, the slide file, the caption generator and VT replay, its only a dirty switch so best not operated on line but for £24.99 it will stop BNC

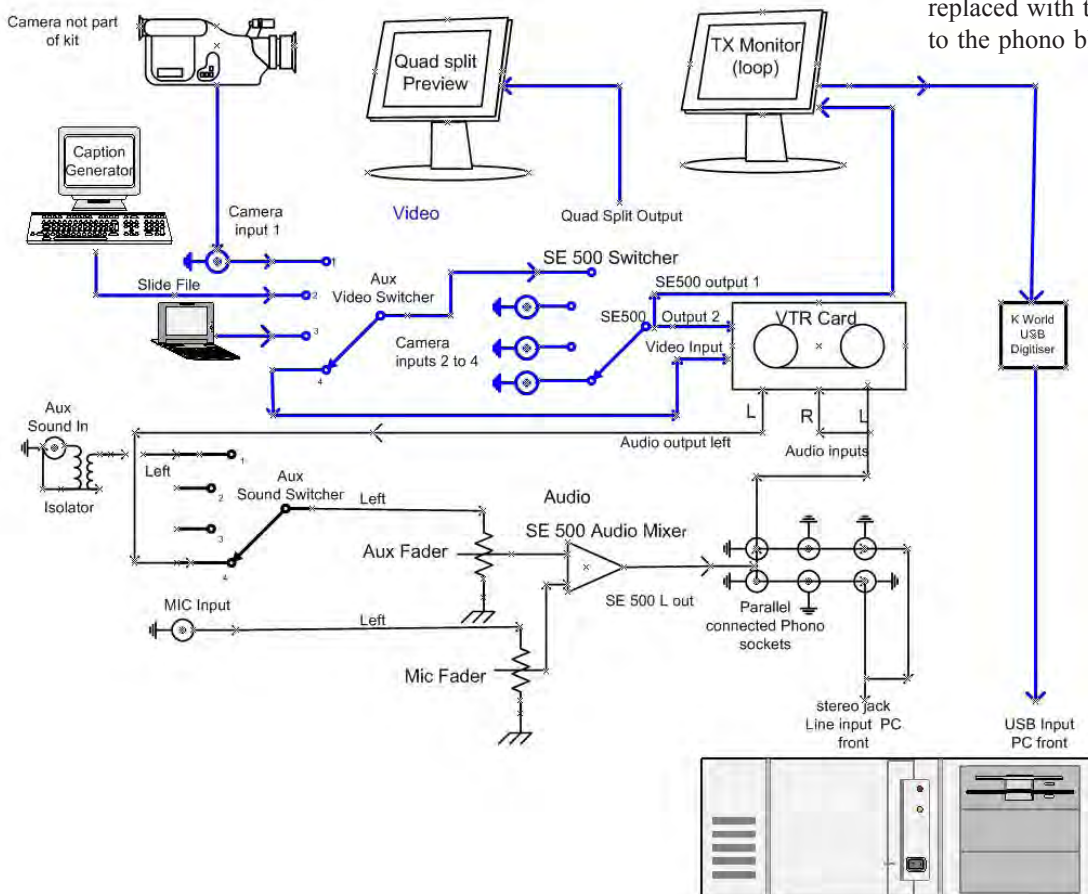





same material onto the hard disc in full resolution

The next outing is the AMSAT meeting fingers crossed the new engineering work and proves it's self.

The rack and all the kit belongs to the club and is available at committee discretion for members to borrow to stream events. If you have an event in mind that you would like to stream then why not submit a plan to any of the committee members , stating when and where the event will take place, who is going to be involved in the production and any other relevant information.

The kit does not have any cameras but it will interface to CCTV and home video cameras and we can help after the event moving a copy of your production from the hard drive to the archive library, although every thing you need to do this yourself is on the computer including a simple time line editor to cover up any problems you had with the live transmission.

changes on site, during the production and to this end the cable loom is tie wrapped to discourage BNC changing activity

The dual LCD monitors have 19" mountings mounted and are fitted at the top of the rack as does the new computer, much as I like the new switcher box It does not rack mount and so sits on top of the computer case and I hope will remain there in transit aided by some self adhesive pads, the caption generator and slide file mount along side of this again on top of the computer case and are held in place with similar pads. Below this is a CPC 1U draw which is mounted inverted and the vision mixer secured in place with screw fixings . All that should be required on site is to power the rack, connect the camera's and audio at the rear, plug in the new cues and talkback box. Keyboards mouse and PC monitor, all these connect to the front of the PC case so rig time should be considerably reduced. Audio can be monitored via headphones plugged into the audio mixer and the headset has a boom microphone that plugs into the talkback box for one way communications with the cameras. This might be upgraded in the future to the very attractive active audio monitoring

[http://cpc.farnell.com/\\_/s-301-120w/internal-200w-speaker/dp/CS14608?Ntt=CS14608](http://cpc.farnell.com/_/s-301-120w/internal-200w-speaker/dp/CS14608?Ntt=CS14608)

One member of the streaming team has already asked me to weigh the kit and it comes in at 35Kg which is really a two man lift, but then you need two people to stream an event and a small folding sack barrow might be the next investment.

The only disappointment was that the video card will only drive a single application, to be expected I suppose, so a K world USB video adaptor is included in the rig to supply video signal to the live media encoder application, and the black magic card records the

**The completed streamer kit does that 5 ¼ bay not scream out for the audio monitoring?**

CPC have on offer at £7.98 a nice speaker that will fit very nicely into the 5 ¼" bay on the front of the rack (only available in white, pity).



# DATV Narrowband Filtering

by Ian Waters G3KKD

In my article in CQ-TV 228 describing a Tunable 70 cm Narrow Band Filter, I said that it would probably be beneficial when receiving DATV but this had not yet been tried.

Tests have now been done and the two spectrum analyser displays show a 2Mb/s QPSK signal received over a 57 km path from G4CPE without and with the filter in circuit. It will be seen that noise and potentially interfering signals on adjacent channels have been reduced significantly with very little effect on the QPSK spectrum. On the picture monitor the signal quality, as measured by the STB, only reduced from 95 to 93%, but the number of occasional dropouts presumably caused by interference seemed to be reduced.

The performance of the filter could perhaps be improved, at the expense of a little more insertion loss, by making a three pole assembly. This would give a better shape so reducing adjacent signals further while also reducing the slight rounding of the QPSK spectrum. The diagram shows the 70 cm receiving arrangements used at G3KKD.

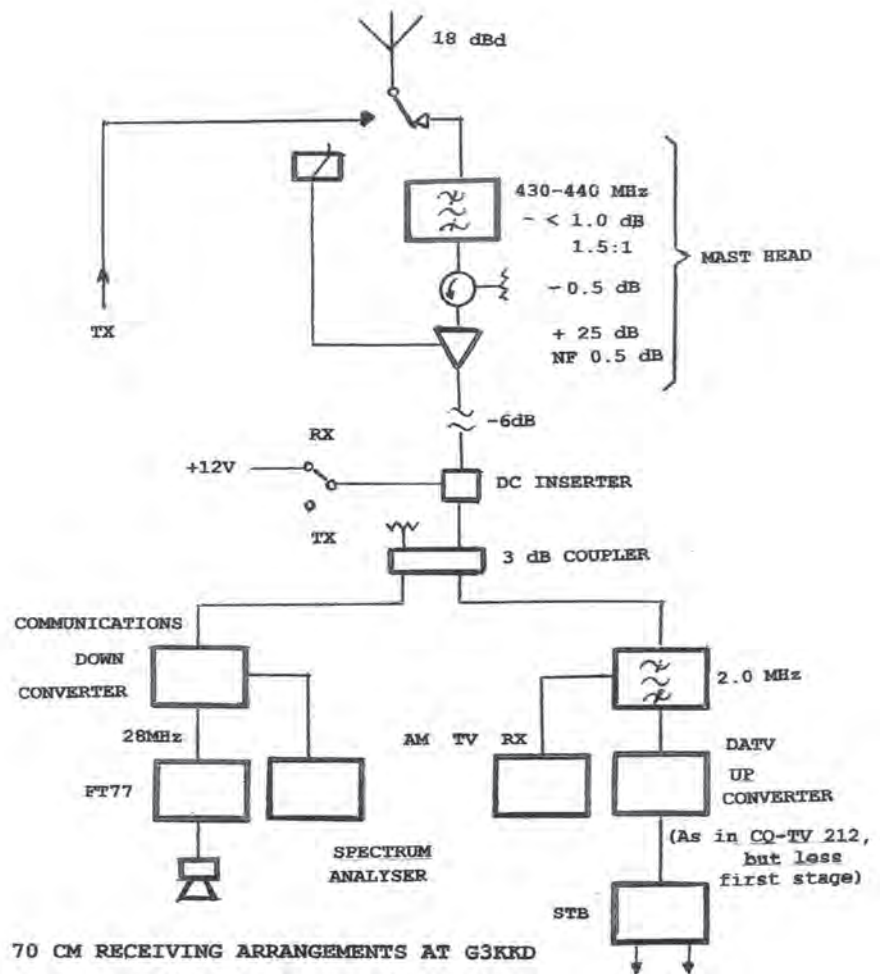

I would like to thank Arthur G4CPE for his patient cooperation during these tests

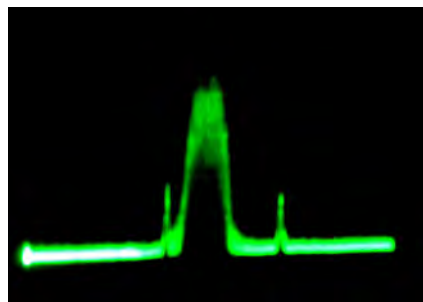
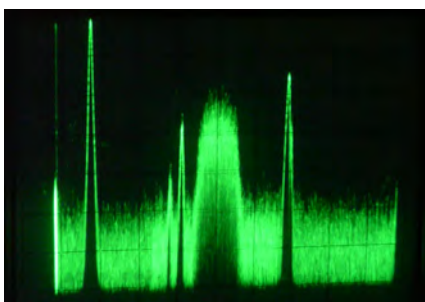

Cyber-membership: CQ-TV beamed directly to your PC  
four times a year for only £4  
Visit: <http://www.batc.org.uk> for details



Dicky Howett writes, Actor Paul Whitsun-Jones surveys the scene, next to a five-lensed EMI 203 image orthicon monochrome camera positioned (and well attended) outside Thames Television's, Teddington studios in Broom Road. These pictures, (taken by local resident Bernard King around about 1968), show Pete Brady interviewing a helicopter pilot. I suspect this was for the children's magazine programme 'Magpie'. There was also a vast 'cherry picker' parked opposite with a couple of seemingly unrestrained camera guys lounging about up above. Obviously these were the good old days, pre-health and safety!



**TV-AMATEUR** die deutsche Amateurfunk-Zeitschrift  
für ATV bringt in der letzten Ausgabe z. B.

- Zweikanal-Audioverstärker wandelt Stereo in Monosignale
- Frequenznutzungsplan vom September
- Tongenerator mit 8 Pegelstufen
- Erste HDTV-Bilder vom Mond
- aktuelle ATV-Relais-Liste
- DVB-T-Sendeversuche DD1KU

bestellen per Fax: 001149 231 48 99 2  
oder Internet: [www.agaf.de](http://www.agaf.de)

# Shack Wiring Revisited

by John Bales G0HAT

Having read Drew Belcher's article on shack wiring in CQ-TV 228 I decided to share with your readers, ideas incorporated in the wiring for my shack.

In addition to a normal lighting circuit, the basic requirements for a shack seem to be for a large number of 13A outlets all of which can be controlled by a master switch and a few additional 13A outlets which stay powered at all times.

In planning a permanent wiring installation for a shack, I would rule out the use of rubber 4 way socket extension panels which are fine for temporary setups but better solutions are available for long term use.

My shack is located in a sectioned off area of the garage space beneath my flat. Initially there was one 13A socket on the wall, luckily part of a ring circuit and protected by an RCD. Walls are solid brick and my approach has been to install around the walls, U-section plastic trunking with a snap in front cover and of suitable width to mount 13A sockets. This arrangement also provides a means of keeping the supply cables out of sight and well protected.

The trunking suppliers provide mounting frames for single and double 13A sockets which makes fitting as many as you require along the front face of the trunking very easy. Within the trunking, wiring is arranged to provide power for heavy loads and those always powered items as part of a ring circuit, whilst a spur box with an integral 13A fuse connected into the ring, protects all the other wiring. This consists of plenty of standard 13A double sockets fed in parallel with a single run of 2.5 mm cable around the shack.

For those not familiar with the British ring main system perhaps I should explain the arrangement. In the UK 13A socket outlets are used for most purposes whether feeding small items such as table lamps or heavier loads

such as fan heaters. From the consumer unit (English speak for fusebox) a cable with 2.5sq mm conductors runs to the first socket outlet. A further cable runs from the first to the second and so on for as many sockets as are required and then a cable connects the last socket in the ring back to the same fuse as fed the first cable. The fuse rating for this circuit will be 30 amps so a total of 30 amps can be drawn from anywhere around the ring. Individual plugs (the pros call them plug tops) fixed to appliances contain a cartridge fuse in the live conductor and this is chosen to suit the load in question: 13 A for heaters, kettles and the like and 5A or 3A for table lamps, radios, TVs and other light loads.



A typical domestic dwelling would probably have two ring circuits within the house, one for upstairs and one for downstairs and with luck, a further ring supplying the garage.

If, as mine is, your shack supply is fed via an RCD protecting both power and lighting circuits, it is probably a good idea to keep a torch handy in an easily



If a sub circuit is needed a spur switch is employed. This is wired into the ring in the same way as other sockets, but has a two pole on/off switch mechanism and a carrier for a 13 a cartridge fuse and possibly a neon indicator. A hard wired circuit is connected to this - in our case many 13A sockets, all fed in parallel with a single 2.5mm cable run - all switched on and off from the spur switch, and appropriately fused to protect the wiring.

locatable place as should the RCD trip whilst you are working in the shack at night, it would be plunged into darkness!

My shack installation was put in several years ago before the latest IEE regs came into force and complies with the regs then in force. However anyone currently wishing to undertake a "permanent" mains installation would be well advised to consult the latest IEE regulations document - available for consultation at public libraries - to ensure that they are complying with the requirements of these regs as some new installations and extensions these days do need professional approval.

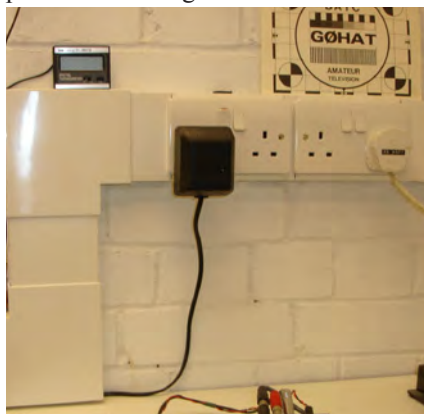

Finally I would mention that prices for trunking vary widely and there are some elaborate multi section types which are quite pricey and not needed in this application so it is advisable to shop around.

# QRP & Buildathon

by Michael Clarke, Mi5MTC

Two QRP presentations recently became available from the British Amateur Television Club archive. Both are excellent, for their technical quality and clearly presented, interesting content, as promotions of core values in amateur radio, and as exemplary outcomes of mutual support among radio amateurs of various interests.

## QRP How and Why

The first posted on the BATC website was the talk "QRP How and Why" by George Dobbs G3RJV, Secretary and founder of the G-QRP Club. It was recorded at April's Lough Erne Amateur Radio Club rally in the SHARE Centre. Neat work by Trevor Brown G8CJS fitted G3RJV's power point slides alongside the audio. Consequently, the details of circuit diagrams, for example, are sharp, clear and linger on-screen long enough to study while following George's engaging discourse on self training, experiment, and building simple equipment, and all this just for plain enjoyment. Indeed, this talk on homebrew construction has relevance much wider than QRP.

As LEARC Chairman, I had invited George to our rally. He offered a talk. We advertised this on amateur radio internet news media. BATC's Ian Able G8ZHI noticed and emailed to suggest streaming. This good idea was taken up by SHARE technician, Vic Purcell Mi6VIC with club members Stephen Hand GI7UIM and Ken O'Reilly GI7UIP. Outcomes were excellent. Thanks to BATC, and yet more news sent out by internet, the enjoyment of the 40 present at George's talk was shared all across the QRP world, with appreciative emails from North America and New Zealand. In chat with Ian G8ZHI, other ideas included the Bath Buildathon DVD...

## Bath Buildathon

Steve Hartley's original Bath Buildathon DVD explains, he wrote, how to organise a Buildathon, and was intended to encourage radio clubs to pick up their soldering irons and start raising solder smoke. Over 60 copies of the DVD have been sent out across the UK and abroad. From the feedback it appears to be having the desired effect.

The short film was made by two Bath ARC members who work in the TV world. It outlines what goes into organising a Buildathon, and shows the participants building and testing their Intermediate project. It was a Brendon double-sideband phone transceiver from Walford Electronics aimed at builders with limited experience where ease of assembly is important. The PCB is laid out with plenty of space. It is supplied for 80m using a ceramic resonator VFO covering the lower half of the phone section.

The Bath DVD is intended to inform and inspire other clubs to have a go at a radio construction event. Its topics are set out in a straightforward fashion, the check lists are numbered with Morse code audio, and there is lots of inspiration and good advice here for both Buildathon organisers and participants. In May this very valuable organisation and training resource became available on the BATC web archive.

## RSGB Kenwood Trophy

BATC made another useful webcast from April's RSGB AGM, where the Kenwood Trophy for outstanding contribution to amateur radio training was awarded to the Bath Buildathon team. All six got certificates of merit - Mike Coombs, G3VTO, Lewis Thomas G4YTN, and Steve Hartley G0FUW, the mentors, Robin Thomson, G3TKF and Julian Baldwin, G3UHK, the film crew, and Tim Walford, G3PCJ, the kit supplier and 'kit-industry' representative. Clearly, wrote Steve, we were all very proud to receive such recognition but all might also like to

know that the RSGB does recognise training efforts. All training volunteers, instructors and invigilators, were singled out for praise by the RSGB President, Dave Wilson, M0OBW.

## A Couple of Notions

Steve G0FUW is also joint editor of the RSGB training manual for the Intermediate and the sole editor of the advanced manual for the Full Licence course, which is largely about theory. Is there a kind of Open University broadcasting role here for BATC with webcasts providing good quality theory presentations in support of Full License courses?

In amateur television there still some scope for home brew construction, and thus for Buildathon projects either with kits or with the methods and approaches in the talk by George G3RJV, and supported by an appropriate webcast on the BATC archive?

Finally, many thanks to BATC on behalf of all the clubs and radio amateurs who have and who will benefit from these and the many other resources across the range of amateur radio interests that are to be found in the BATC archive.

Email [mi5mtc@learc.eu](mailto:mi5mtc@learc.eu)

## Websites

Bath Amateur Radio Club  
<http://batharc.org.uk>

BATC Streamer  
<http://www.batc.tv>

G-QRP Club  
<http://www.gqrp.com>

Lough Erne Amateur Radio Club  
<http://www.learc.eu>

SHARE Centre  
<http://www.sharevillage.org>

Walford Electronics  
<http://www.walfordelectronics.co.uk>

# Camera choice. Vintage or not so vintage?

by Brian Summers

I have been collecting cameras and caring for them for a good number of years now and I am often asked if they still work. This can be a problem for the older cameras, but less of a problem for those that are just middle aged! Sometimes I explain that like retired fire engines, they may pump a bit of water now and then, but they don't put out fires any more!

Recently I took two of my retired cameras to the "RSGB BGM" to help with the production and streaming to the internet. So in the event they did, by analogy, "put a fire out" again! This got me to thinking as to what the serious ATVer might get from the use of Ex Broadcast cameras, so here is a description of the Philips (BTS) LDK90 cameras that I used.

It might sound strange, but one of the advantages of the LDK90 is its size; small enough to pick up and wear on the shoulder, but big enough to avoid shakes and jerky movement. The lens gives smooth "rate" controlled zoom action and the controls are ergonomically placed on the lens side grip. The camera has a monocular viewfinder with adjustments for position and correction adjustment for those with vision problems. There is a large 5" viewfinder option so that the camera can be used in "studio mode". The idea is to give smooth pictures thus avoiding the dreadfully amateurish wobbly vision!

The lens is worth special consideration. My LDK90 has a nice Canon lens with an 18x6.2 range plus the x2 extender. The minimum zoom setting of 6.2 is not quite as wide as today's cameras but still wide enough to be useful in hand held mode. If you consider how hard it is to hold a camera steady when zoomed in tight, the opposite is true and with a very wide angle lens it is easy to offer what appears to be a steady shot. A drawback with this is that barrel distortion is very noticeable on wide angle close ups, especially of faces. In your face really! Back to the lens, it also has the remote

The Philips (BTS) LDK90



zoom demand control ZSD31M and focus servo, FPM-70 with its control the FPD-40. These make studio style tripod operation easy.

Technically the LDK90 is a first generation Broadcast CCD camera, no tubes, no lag, no comet tails, no registration, and the only automatics are White, Black and Iris. To get professional results the iris and the exposure has to be carefully and thoughtfully used. On the lens there is a button for auto iris which you can dab before the shot starts so the exposure is set and does not change thus spoiling the take. There is no auto focus! In some ways it is similar to

the comparison between a small point and click still camera and the extended control options available in an SLR still camera.

The LDK90 is a Multi role camera with a wide range of options

- Stand alone ENG with a self contained recorder back.
- Stand alone with plain video output.
- Single camera EFP with multicore to remote control unit.
- Triax operation to studio or OB unit.
- The LDK90 is a "two part" camera with a choice of the "back" according to need.

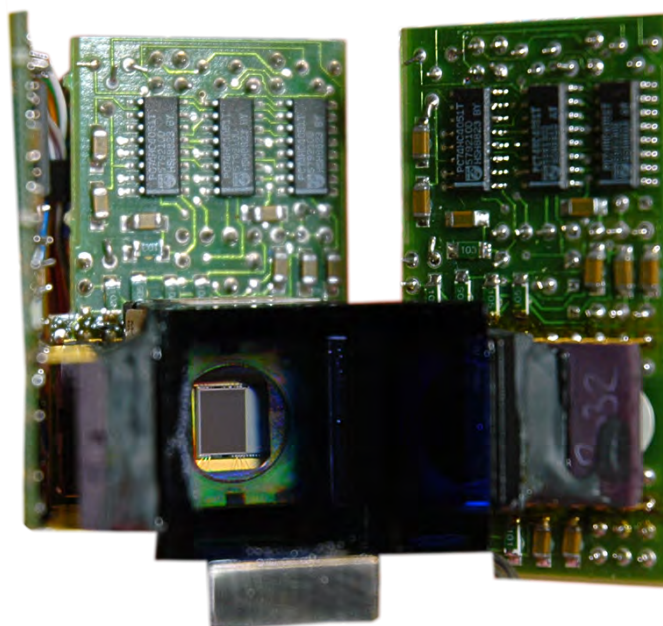

Behind the lens is the prism block, the light splitter, and through it you can see the 3 CCD's

There are BNCs (proper connectors) for genlock in and video and monitor out, an XLR4 for 12v. DC input, headset jack, external microphone XLR (programme) and selection of other connectors according to role. The whole thing is therefore robust and able to withstand the rigours of broadcast life. The camera can be powered from an internal battery, external belt battery, or via the multi core camera cable from the RCU/PSU. The current consumption is about 1amp at 12volts for the basic camera.

The LDK90 uses a Frame Transfer CCD type NXA 1000 (FT4). This has 604 pixels per line in 625 or 610 pixels per line in 525 lines. This uses a rotating shutter, blanking the incoming light during the frame pull-down period. It was fully described in the SMPTE journal of March 1991. There is a microprocessor to deal with the housekeeping and menu systems.



Rear of the EFP back with connectors for VTR and or CCU

With the side panel removed you can see some of the dozens of “adjustments”!

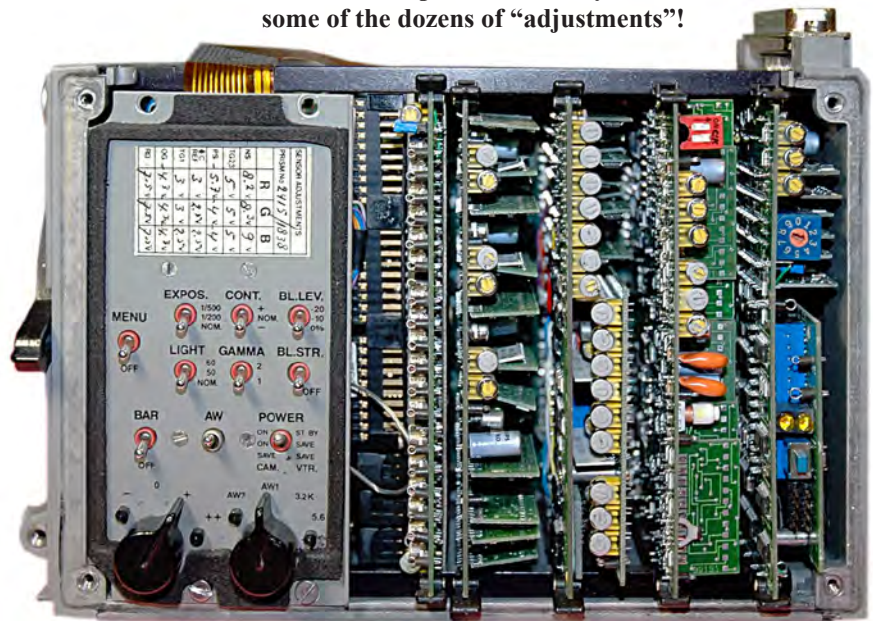

Maintenance: This is possible, but not at all easy! Once you open the water resistant side panels you find a row of plug in cards that are well covered with surface mount components. These are of a size where it is still feasible to replace them, when and if, you have figured out which part is at fault. The LDK90 is now pushing a quarter of a century old and you should not expect perfect reliability. Servicing is not for the fainthearted. The maintenance handbook is some 3 inches thick! A good tactic is to have a second, or even a third, camera as a donor for spare parts.

In the UK the BBC and Granada had the LDK90. As well as studio use the BBC used them a lot for outside broadcasts often as a radio camera with a modified camera back that had the adaptations needed for radio working. Apart from the outgoing video transmitter there was a data receiver and interface circuits so that the camera exposure, black level, colour balance and cues could be controlled from a central point. A mix of production talkback, programme sound and engineering talkback would

have been on a separate walkie talkie with headset.

Although I have written about the Philips LDK90, there are equally excellent products made by Sony, Ikegami, Panasonic, JVC and others. Many of these are newer and have a better specification than the LDK90. I hope to write more on these for future CQ-TVs.

Where to get a Not-so-Vintage camera? The obvious answer is E-Bay, but this needs to be treated with more than a bit of caution! Most cameras when they have finished their broadcast life are still usable for low end broadcast and they still command a good price. The secret is to catch them as they leave the second owner and before they get too badly treated. Sometimes they come out of service in batches, say 6, and a small group of amateurs can often make up 3 or 4 nice workers from that batch and have some spares to boot!

<http://www.tvcameramuseum.org>  
email: [secretary@batc.org.uk](mailto:secretary@batc.org.uk)

## ATV Newsletter

The ATV Newsletter is a weekly publication covering World ATV News that I find interesting as well as events, projects and activities sent to me by my readers. You also get the latest Local ATV News from the repeater networks here in Southern California. And it's free. Plus information on Digital-ATV/ATV GUIDE, for weekly scheduled ATV events via Streaming Video/ATV Website Links/and more. To subscribe send me an email with your first name and call to [atv-newsletter@hotmail.com](mailto:atv-newsletter@hotmail.com) and I will add you to the mailing list. You can also include any info about your ATV activities in your email, if you wish. I just might put it in the newsletter!

Bryon Foster - N6IFU (Editor & Publisher of the ATV Newsletter)

# Digital Upgrade to GB3GW

by Derek G. Whitehead GW3FDZ

GB3GW is located at Pentrefelyn near the town of Criccieth in North Wales at a height of 176 metres (ngrSH514402) giving good coverage of Cardigan Bay and the south side of the Llyn Peninsula. (Fig 1.)

The repeater has been operating for the past ten years with only minor outages. It was decided therefore that the time had come to update it to a digital transmission but due to the high cost of digital encoding equipment leave the receiving side in it's analogue mode. The mode of transmission update to be the DVB-S system which is compatible with free to air Satellite receivers.

To achieve this two boards (designed and built by the AGAF organization in Wuppertal in Germany) were purchased from the BATC. The output of the boards was programmed for 437.25 MHz therefore an upconverter to 1310MHz for the repeater output frequency was required. This item was kindly designed, built and donated by DJ8DW. A line driver amplifier was then built to boost the output.

In the original design the analogue exciter (using the Eisch Electronic Universeller FM-ATVSteursender system) had been constructed in a plug-in metallic module which only required Video/Audio and power in and an N connector for the output. The repeater output power amplifier was a separate unit on the rear of the rack. This design made it possible for an easy conversion to be made by removing the analogue exciter and replacing it with the digital system.

A separate cabinet for the digital exciter was obtained from GW3XDO/P and the digital components of boards, upconverter, line driver amplifier and necessary power supplies were assembled in the cabinet by MW1WEJ. (Fig 2.) The cabinet was then attached to the side of the existing rack (Fig 3.) requiring only Audio and Video to be fed in (from the socket of the analogue



Fig.2



Fig.3



Fig.4



exciter module) and the output connected to the original analogue output power amplifier. This method proved to be very efficient as the whole upgrade was accomplished in just under ninety minutes on the 19th of May 2010.

Fig 4 shows myself with Brian Davies, GW4KAZ (Chairman of our Arfon repeater group) in front of the rack with the digi box mounted on the left side. The gap where the analogue exciter had been located can be seen on the left of the inside. The equipment on the shelves above is the two metre repeater GB3DW.

The digital output transmission has been set as follows:-

Modulation:	QPSK
Elementary Stream:	6MB/s
Symbol Rate	4,167MS/s
FEC:	7/8.

Thanks must be made to MW1WEJ, DJ8DW, GW3XDO/P, GW4KAZ, GW3JGA & Jack Elliott for the successful completion of this upgrade.

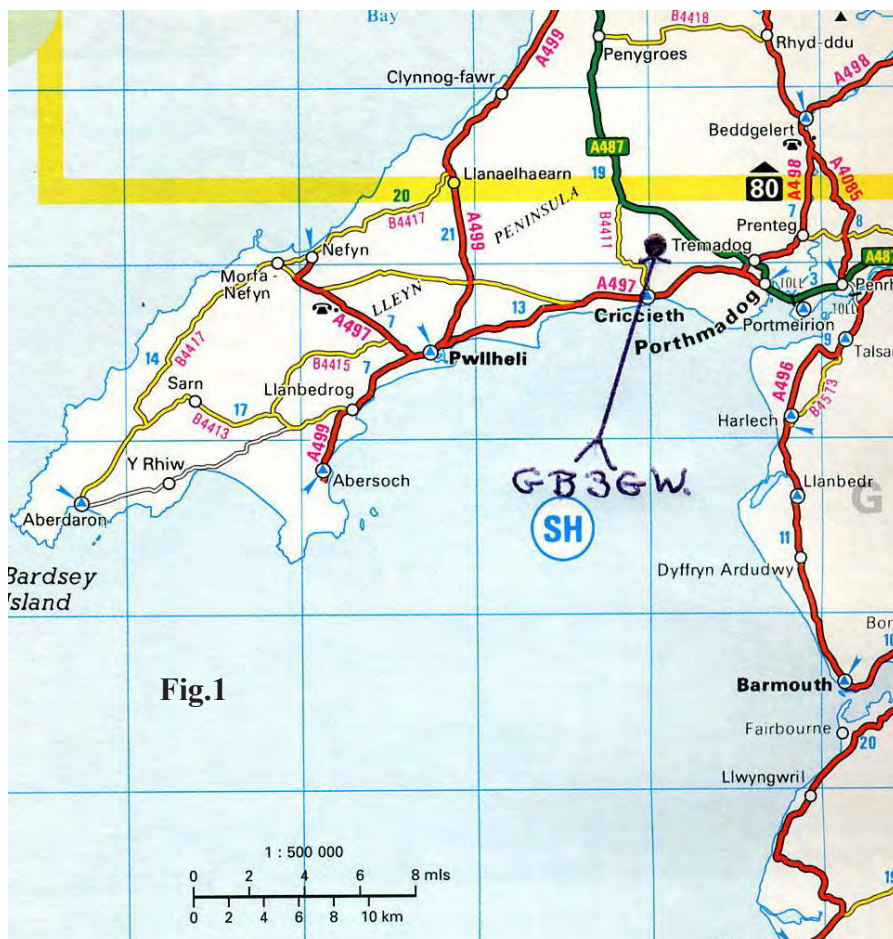

Fig.1

## Letters to the Editor

Hi Chris,

There is big changes happening here [in New Zealand] with band plans, I am hoping that there is still room for wide band modes such as ATV. Digital amateur television is now starting to more commonly used up and down the country. At this stage mainly for repeater inputs using the DVB-S format. Unlike the UK we have a 50 cm band at 614 to 622 MHz this band is use for the repeater outputs. At the moment these repeaters are using analog VSB. With digital change over not far off, the Auckland ATV group is in the process of finding funds needed for this switch over. Since all new digital TV receivers are able receive channel 39 UHF. This new mode will likely to be DVB-T (COFDM), with such a high profile this should get the attention of the public. Who knows this may even get new members into our hobby.

Regards, Grant ZL1WTT

Hi Chris,

Just a short update on VK3RTV in Melbourne: We now have running:

VK3RTV1  
1255 Mhz DVB-S or 1250 Mhz Analogue

VK3RTV2  
1276 Mhz DVB-S or 10.41 Ghz Analogue

Stereo sound on all channels, automatic on DVB-S, DTMF selected on Analogue inputs.

Great to see an article from VK in CQTV, have been a member for a very long time, right back to the early small CQTV books and valve transmitters.

Regards  
Peter VK3BFG

Having a clearout:

I have the following CQ TV magazines to dispose of as one lot.  
Nos. 81,91,94,99,(all copies 108 to 229)  
All in as received, good condition.  
(heavy,30 years worth)

Offers to include postage.

Regards,  
Derek Dunn G8KOV  
derek@rodmoor.freemove.co.uk



# Remote Infra-Red control of satellite receiver decoders

by Peter Blakeborough G3PYB

The Isle of Wight repeater GB3IV has the facility to transmit digital signals using 4 MS/s QPSK DVB-S format on 23cm (1316MHz). Analogue or digital transmission is selected through a DTMF command.

The group managing the repeater (SCART) decided to add extra receivers for 3cm and 70cm in addition to the 23cm digital input on 1249MHz again selected by DTMF commands.

learned command can be from different IR manufactures, and different signal protocol. The unit effectively learns the whole sequence as presented by the original IR hand control. The learn process is aided by an additional red LED to indicate the received sequence. Two operational modes are available to allow selection by a matrix type key panel or by direct selection of the 4 bit address word. For my IRD control application I only need one command for the info. page and fortunately it was a toggle command so the same command

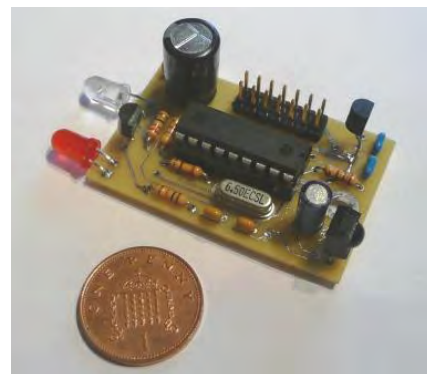

The analogue receiver on 23cm and 3cm have signal strength indicator bars presented in video for a short duration when a receiver signal is seen. A similar signal indicator would be a desirable feature to help user to confirm a viable input signal.

A number of digital receivers were donated to the group (Comag SL55), which has an excellent info. page with signal strength, BER and other channel information such as frequency and Symbol rate. Unfortunately this page was only available though he use of the remote IR hand controller.

With some development work it would be possible to emulate the IR code for the info. page and make a direct hardware connection. Drawbacks for such an arrangement included further work in the event the receiver type was changed later, with yet another type of IR controller. A search of the WEB and past CQ-TV documents only confirmed the extent of the work needed. However on one search I found a most useful device from TaunTek a trainable IR remote control device. TaunTek have produced a small kit with a PIC processor, onboard IR receiver and transmit IR LED. The device can store up to 16 different commands each

is used again. I added three transistors and three IR diodes to send the same info. command to three different digital receivers 23cm, 3 cm and 70cm. Only one receiver can be used at once in the GB3IV system toggling all the receivers with one dtmf had no drawbacks. In the event more feature are needed such as changing the channel some form of switching to direct the command to individual receiver will be needed. The learn receiver is approximately centred on 38KHz in terms of RX sensitively but the digital processing is based on the more usual 37.8KHz.

Excellent clear documentation including the memory selection methods can be down loaded from the TaunTek website: <http://www.tauntek.com/IRMimic-chip-datasheet.pdf>



Fig2 Info page

The cost of the whole IRMimic Kit was \$29.95 USD, PCB only and PICs are also available separately. This most useful device can be used for a wide range of command function and the ability to mix different IR controller protocol add extra value. The key functions of the iRMimic are reproduced below with acknowledgement of the source material to TaunTek. IRMimic™ Trainable IR Remote Control Transmitter

## IRMimic features:

- Simple to train - Can learn up to 16 IR commands, and each can be in a different format/protocol
- Two different operating modes - Keypad or MCU interface
- LED indicator output - Indicates training is complete
- Small size - 18 pin DIP IC
- Chip operates from 3-5 volts DC
- Standby mode permits battery operation
- Can learn many different IR remote control protocols. Not limited to a few specific ones.
- In keypad mode, most remote control commands are repeated if key is held down.
- Kit w/pcb board available for easy implementation. (All through-hole components for easy assembly.)

# How to use the BATC streamer

by Brian Kelly & Trevor Brown

We are frequently asked, either by email to the Membership Department or by people watching live broadcasts, how to get and use a streaming channel. We are going to explain how to apply for a channel and how best to use it in this article.

## Applying for a streamer channel

Streamer channels are available to all members and affiliated TV repeater groups but we do not automatically provide a channel, you have to apply for one. The reason is straight forward, it costs money and takes time to set up and run a channel and the majority of members have no interest in broadcasting through one. To give around 1,000 channels when they would rarely if ever be used would be a huge strain on Club resources and the demands on the server hardware would reduce the service quality to everyone. Instead, we make it as painless as possible to apply for and set up a channel when one is requested from us. There are several ways to make an application, all are through the website, please note that requests by post or telephone cannot be processed as the membership department has no access to the streamer configuration files. The easiest method is to go to the streamer home page at [www.batc.tv](http://www.batc.tv) and in the centre panel, near the bottom click on the word “ask”, it’s highlighted in yellow to make it more

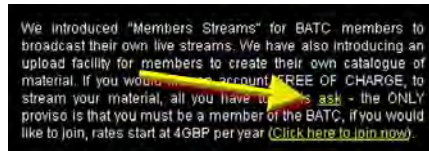

prominent. You can also reach it from the repeater selection page by clicking where it offers streaming to repeater groups. Although the procedure for repeaters is slightly different, there is a link to members stream applications on



that page as well. If you are happy to type into your web browsers URL bar, you can also reach the application form at “[www.batc.tv/register.php](http://www.batc.tv/register.php)”. There you will be asked to complete a form and a few very simple questions. You will need your membership number so we can confirm you are eligible, if you don’t know it, contact the Membership Secretary who will tell you. Please be sensible if you request it by email, you would be surprised how many requests we get where people forget to tell us their name, address or callsign, we do our best to work out who you are but we are not MI5 !

If your application is accepted, you will receive an email with details of where to download the necessary software from. At the moment this is “[www.adobe.com/products/flashmediaserver/flashmediaencoder/](http://www.adobe.com/products/flashmediaserver/flashmediaencoder/)” and you should look on the page for the free download, the current version is 3.1 and it is available for Windows and Mac systems. The email will also tell you your personal stream settings which you enter into the programs configuration screen, more on this later.

## Configuring the streamer program

When the Flash Media Encoder is installed and running, you should see something like the picture below. At this stage it’s unlikely you will have



images in the two boxes at the top, some setting up has to be done first. The Flash encoder doesn’t have any video or sound inputs of it’s own, it asks the operating system to tell it which ones are already connected to the computer. If you don’t have video or audio inputs we will explain how to add them a

little later, for now assume they are already installed and working in other applications.

The program window is split into four sections, the top is the ‘in’ and ‘out’ video screens and an audio “VU” bar graph, similar to those you might see on a mixing desk. You can enable and disable each of these by ticking the ‘Preview’ boxes below the right screen. You can also alter the size of the video screens by ‘zooming’ with the controls above them. By default they use 100% zoom and are the size of the input video source. If you want to temporarily mute the sound, click on the small louspeaker icon at the bottom of the bar graph.

The lower left section is where you select the video source and streaming parameters. Adobe have made provision for saving different settings

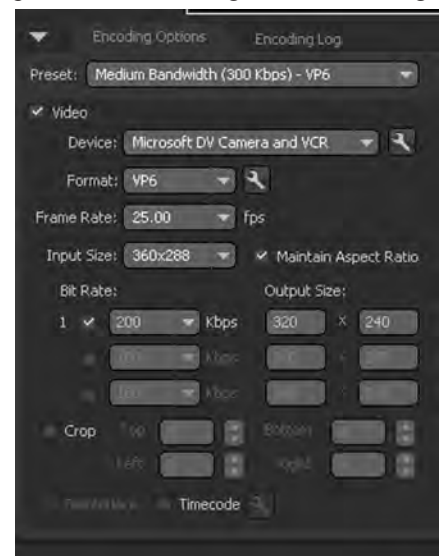

in ‘Profiles’, the settings you are using are automatically saved in a profile called “startup.xml” when you leave the program but if you want to save other configurations, use the ‘File’ option in the header bar and save them under a different name. The ‘startup’ profile is reloaded by default when you start the program. So be careful if you overwrite it with inappropriate settings, if in doubt, delete it and a new one will be created for you. For most users, selecting the presets “Low Bandwidth – VP6” or “Medium Bandwidth -VP6” will work well.

The bandwidth is a measure of how much data has to be transferred over the internet per frame of video. Higher bandwidth gives a sharper picture but also needs a faster broadband connection. Some experimenting may be necessary to get best results, the best way is to simultaneously open a web browser and look at your own stream, if you use a bandwidth wider than your connection can handle, the returning picture will have interruptions and the 'Barbers pole' beneath it will flash with stripes. As you change the 'Presets' you will notice the settings for format, frame rate and input size also change as together these decide the bandwidth to be used. You can still make tweaks to these if you want to, the presets are just recommended settings. Lower in the left panel you will see a 'Crop' check box, we recommend you leave it unchecked for normal use. If you really want to crop the picture edges, click to activate the function then either enter the margin widths in the appropriate box or drag the edges of the input image to the positions you want.

The lower middle section of the program window is the audio settings. These work in the same way as the video settings



and also change according to the preset chosen. Below them is a volume slider which sets the audio level on the outgoing stream, note that this does not adjust the incoming volume so the bargraph beside the incoming video picture is not affected. To adjust the incoming level you must use the computers own mixer software. Some computers have automatic level controls which cannot be overridden so you just have to accept whatever level it sets for you. Finally in the middle section there is a summary

of the outgoing data rate. Almost everybody has a broadband connection using a system called ADSL which is optimised for fast downloading at the expense of upload speed. Remember in this application you are sending, not receiving Internet traffic and typically the maximum upload speed is one eighth of the download speed. So if you have a 4Mbs broadband connection, your top upload speed is probably 512Kbs, don't be surprised if you can't reach the speed your internet provider advertises.

The bottom right section of the program window has two options "Output" and "Metadata". The streamer ignores the

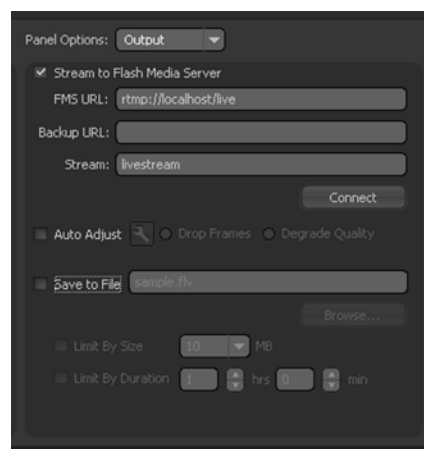

Metadata entries so lets concentrate on the Output options. Near the top is a check box marked "Stream to Flash Media Server" which should be enabled for others to be able to see your material. There is a reason behind the apparent madness of havng a streamer that doesn't stream, the explanation is the box below marked "Save to file" which lets you use the program to prepare a file which you can upload later, in other words, 'not live'. This is useful if for example you are covering an event but do not have internet access at the time, you can record it in the correct format for uploading to the web site later. The "FMS URL" box holds the target address of your stream on the BATC server, you will be given this and the 'Stream name' details when your stream is created by the Webmaster.

Adobe have provided two alternative ways of handling a degrading internet connection, if you enable "Auto adjust" you can either opt for dropping frames or dropping quality. Dropped frames will show as stuttering in the picture while dropping quality will result in a

blurred or pixelated picture, the choice is yours, hopefully you never need it anyway! If you save to file, you must give a file name on your computer to save the stream to. The files can become very large if you leave them recording for long periods, so make sure you have plenty of disk space available for them. In the bottom right corner you will see a check box marked "DVB Auto Record", this has nothing to do with recordings made on your own computer, it isn't enabled at the server but if it was, this would start recording the incoming stream on the server's own storage disks. Please leave it unchecked.

### Going live

When you have everything set up, the final step is to activate the stream. There are two steps, firstly, click on the button marked "Connect", this establishes a connection between your computer and the BATC streamer computer in London. Then click on the green "Start" button at the bottom of the screen. After a few seconds your stream should be visible World wide. When you have finished, please click the red "Stop" button and disconnect from the server, if you leave it running it ties up server resources and also leaves your entry in the web page listings saying you are still active.

You can get statistics and a log of actions by clicking on "Encoding Log" beneath the incoming video window. This will show a log of connections to the server and gives an indication of the current and average streaming speeds. If you run into difficulty, quoting these figures may give clues about where the problem lies.

### AV Ins and outs

We haven't looked at where the streamer gets it's video and audio from yet. Obviously, you have to feed signals into your computer before they can be streamed out. The picture and sound can come from different sources and the Flash Media Encoder software will use the sources you select in the video and audio "Device" boxes in the configuration screen. If the operating system reports more than one source is available, you can select the one to use using the drop-down arrow at the end of the Device box. If no devices are found, the problem is in your operating system,

not the Adobe program as it only lists devices it is told are present. It's quite likely you already have a suitable audio input, most computers have "Mic" or "Line" sockets which you can use and which will normally be identified in the Devices list by the name of the audio IC used on the mother board. Examples are "AC3", "Realtek" and "CrystalAudio". You may also have a video input if you use an ATI or Nvidia video display card. Many of these have a small DIN socket or phono socket on the rear panel but it probably won't show as a video capturing device unless something is plugged into it. If you have a DVB or satellite receiver card you may find it also has a composite video input socket on it.

If you need to add a video capture device there are several options. The best is to use a Firewire (aka IEEE1394) capture card which will connect to most camcorders. This is a bulletproof system, just plug it in and it works. Alternatively, there are many USB capture boxes and 'sticks' (below) on the market which will do the job. These are usually



manufactured in Asia and can be very cheap but the software drivers provided with them is often prone to problems and support from vendors is often non-existent. Most people get them working eventually but be prepared for a some experimentation! If the video works but the sound doesn't, you can always try splitting them with video sent to the capture device and audio to the computers own sound inputs.

Note that the Adobe Flash Media Encoder only works with live inputs, it is incapable of sending pre-recorded material from files on your computer. You can of course play back recorded material from other hardware and connect it to a capture input.

### Uploading files to the web site

Live broadcasts are sent through a members stream but there is also a facility to upload files to the web site "Film Archive". The files have to be in a format called FLV (FLash Video) and there is a limit of 200Mb on the file size. This is equivalent to about one hour of video, if the production is longer, you have to split it and encode each part as separate FLV files. To send files you have to log in to the streamer site and click on the link "Upload Content", there is a section to complete which allows you to add a description to the

file. Please take note of the instructions about allowed file names, if necessary, rename your file as described before selecting it for upload. Transferring a file can take quite a long time and the progress bar only gives an approximate indication of time left, please wait for the "You have been successful" message before logging out.

As mentioned earlier, the Adobe encoder can produce files in streamer ready format. Alternatively you can convert existing video files to FLV format using software on your computer. Several free utilities are available including "SUPER" from eRightSoft, "VLC" from videolan.org and "Riva FLV Encoder" from rivavx.com. Of these the Riva encoder (see below) is probably the easiest to use, all you have to do is select the file to encode, tell it the name of the FLV file you want it to create then click on "Encode". The program doesn't have a progress indicator so you have to wait for it to tell you it has finished but it is quite fast. With most FLV encoders you can set the video resolution, please remember that higher resolution means bigger files and longer upload and download times and also faster streaming is needed. Viewers with slower internet connections may have difficulty seeing high resolution streamed video.

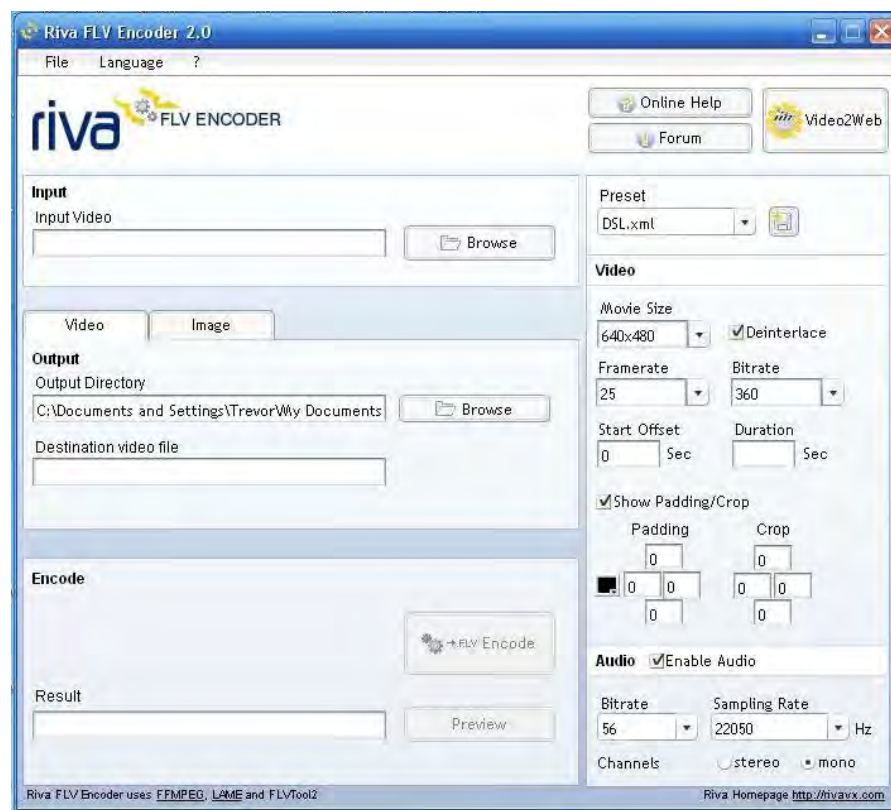

# Lincolnshire Steam and Vintage Vehicle Rally

by Paul Marshall

We did this show again, but this year at very short notice and after a lot of indecision. It was, I reckon, our tenth year of taking OB trucks to the annual steam rally at the Lincolnshire Showground. The saga began in 2000 when we took the newly painted and refurbished 'Southern' with one camera and a lot of worries about the truck as a 'one time only', but we were hooked and kept going back. By around 2005 'Yorks -Tyne Tees' had joined in and it was becoming a pretty major event in the year for us. By the 2009 event Richard Harris had completed the vehicle restoration phase of his Bedford TK ex-BBC VT truck and that then joined in the party. Could we, should we, do it again? This year I found myself struggling on several fronts – problems with the number of passes that the organisers would provide us with, provision of the needed on-site power following the appointment of new contractors, the problem of chronic lack of time as my part-time academic studies draw to a conclusion, another big TV event just two weeks before eating up more time and a general feeling of 'not this year'. The required passes duly arrived, everyone in the team, especially Dave Hill, seemed keen and the idea of passing on the tenth year seemed a little mean. Ah well, better do it then . . .

## Mr Snoddie (a.k.a. Paul Hundy) at work



Neither truck had been out this year, which is unusual, so no advance preparation had taken place. Only sporadic truck and gear maintenance had been carried out as and when possible over the last year but not the usual regular 'power up' and test activities. This was going to be a 'wing and a prayer' exercise and under difficult circumstances. A frantic two weeks of evenings and weekends by Dave and myself proved that the basic technical infrastructure was still sound in both trucks. A leaky (neutral to earth electrical

type of leak) air con unit in Southern was the most disappointing discovery but as it was the front one, not a show stopper. It's never been that brilliant anyway but now all it does is blow air around after the compressor was disconnected. Wanted: Air con expert that a) doesn't say 'Needs a new one gov', b) knows what he's talking about and c) doesn't charge the earth. We soon had Yorks Tyne Tees's Marconi Mk V, Mk X and two Mk IVs up and running with a few minor faults known to be on the list fixed just for good measure. The truck was cleaned, waxed and polished by the application of some money in the hand of teenager on school holiday and it was then almost ready. 'A test drive would be good', I thought, as it's not been out for a year and it IS 43 year old. Sadly, this wasn't going to happen as the HGV driver, Sam, is now working nights and not in a position to take either truck for a 'spin'. It'll be alright, we've always made it back (eventually).



**Image Orthicons on show - two Marconi MkIVs, a MkV and a Plumbicon interloper, the one that never was, a MkX. All available ND in place - it was a very bright day!**

Southern was the next target for attention and after fixing the 'known' problem of a dead Barco Series 2 and a number of other outstanding issues like the rear side door threshold wood rot, it was time to test the Mk VII colour cameras. Camera 4 had a problem with a bad steel cored co-ax on red and an issue with a bad capacitor on the pulses board, otherwise

**An overall view of our exhibit. Left to right: Bedford VAL Southern (with two Marconi MkVIIIs and an Ikegami 355), Richard's Bedford TK BBC VT truck, Jill's Bedford TK horsebox, Bedford KML Yorks - Tyne Tees (with two Marconi MkIVs, a MkV and a MkX) and in the foreground Mr Snoddie's workshop with the 'Project Vivat' and Marconi MkII behind.**



it was OK. Camera 1 (we only ever run two cameras at this event) just came up and worked – not bad after sitting there for a whole year. A few hours into the test and a smoothing capacitor in the Aperture Corrector started to play up with slight hum bars on the screen. That was soon changed and after a one day soak test the cameras were pronounced fit to go, as was the rest of the technical load and the truck itself. Southern's other camera, a modern Ikegami 355 CCD (used to 'compare and contrast') was put back in and was also declared 'healthy'.

Richard Harris and Paul Hundy turned up on the Thursday before the show along with Dave (back again) and the prep went into high gear. Very heavy rain on the Thursday evening was a worry – both trucks being outside, but come Friday morning everything seemed to be fine with the storage heaters and dehumidifiers having risen to the task. Well, it all seemed to be fine until one of the Marconi MkV PWMs at the rear of Southern decided to expire. That was a surprise, not expected at all. That particular unit was one of the first bits of gear put in Southern by me in about 1996. It's never gone wrong since that date but here it was with a tricky fault. It was decided to swap it out with a spare, but that proved to have problems too. Hey, it's only one monitor out of dozens, but it is THE one that I depend on for several functions and it was annoying me. It looks like the slight gap in the rear door of Southern let in a waft of damp overnight as it's the EHT that's expired. That's one for another day. Ho hum.

Back to the prep and the loading of the trucks (including the horse box used as a tender) was almost complete by 4 pm. The two HGV drivers, Sam and Kitch, were expected about 5.30 and we planned to be there by about 7 pm. To cut a long story short we made it but only after a short stop at the side of the road to bleed Yorks -Tyne Tees's fuel lines. Well, it had been stood for a year, I mused. Given the weather that night we elected to return home to eat and drink instead of staying over at the showground. Yet more heavy rain that night but I was confident that the electrical leakage on both trucks would hold. The appearance of 30 mA RCCBs on outdoor feeds can make operations with old OBs 'interesting' but after many years we're down to a leakage of less than 10 mA on both trucks which is pretty good given the age of the kit and the wiring. Richard H had to go off to work on Saturday but promised to return asap. As it happened his work was cancelled and he was back sooner than expected, surprising all of us.

Day 1 of the show (Saturday) – a good early start setting up all the tripods, pedestals, cameras and display materials. The 'show' for the centre area was as per 2009 as there hadn't been time to think of anything new. This was Mr Snoddie's TV Workshop, remembering the name of Donald Bullock's fictional TV repair shop in 'Television' magazine many years ago, which in itself was an echo of the well know Les Lawry-Johns column. For those that remember, that featured memorable customers such as Jack Dawe and his brother Oven and the indomitable 'Beardy' and Non-Beardy'.

Mr Snoddie was the competition 'down the road' in Donald Bullock's column, where all the difficult customers and jobs were sent. Once again, our own 'Mr Snoddie' was played by Paul Hundy surrounded by vintage test gear and half assembled repair jobs.

The other display item was centred on the Marconi Mk II (the only non-working item on show) and featured 'Project Vivat'. Great interest was shown in this by the public with a frequent comment being 'I thought the BBC, or somebody, would be sponsoring this'. They're not, of course . . .

The weather proved to be variable with at least two quick dashes to put camera covers on and drag vulnerable items under cover. The showers were very heavy but fortunately didn't last too long. Everything worked just fine and we were all able to spend a lot of time with the public explaining things and generally chatting. Come the Saturday evening and Sam had an idea – 'why don't we bring Richard's VT truck?' Strictly we had no invitation for it but we did have spare power and a valid spare pass into the showground. It seemed like Sam wanted to do it and Richard was up for it as the truck is only parked a few miles away. The truck was duly fetched by Sam, plugged up and set in operation ready for the Sunday show. We were then able to go off and look round the evening scene of Gavioli organs, beer, cider, the 'coal smell' of the traction engines and dodging the miniature engines threading their way through the crowds. We stayed over, as normal, and so we were on site ready to set up for the Sunday which proved to be bright, sunny and hot. We were then trying to keep things cool rather than dry but everything was again fine on the technical front and the visitor numbers seemed to be about normal for the show. All too soon it was the end of the day and the dreaded 'packing up' routine was upon us. Fortunately we had plenty of help this year and we were all packed in double quick time with the convoy of vehicles ready to hit the road before 7pm. The plan was to get the vehicles home and then enjoy a big meal with plenty of wine. Well, that was the plan...

On the way home, about half way, Yorks -Tyne Tees decided to start coughing and refusing to go very fast, eventually grinding to a halt just outside Sturton by Stow. To cut a long story very short it was first suspected that it was the fuel lines again. It wasn't. Then it was thought that the fuel gauge was lying. It wasn't. Then after some logical deduction by Sam it was decided that the lift pump was ill. Now, for those attuned to big Bedfords, this is a well known problem. Richard's truck had had the same problem the previous year and Southern's is known to leak. Here was the piece of luck; prior to the show, Sam had decided to change the one in Southern but had never quite managed to find the time to do it other than buying the pump. We had a spare! A quick run around in terms of transport and a brand new pump was ready for fitting at the roadside. The job of the lift pump is simply to suck up the diesel from the tank and feed it into the injector pump system. It's secured by two bolts and has two pipes (fuel in and out), so changing it was fairly simple apart from yet another bleed down. By now darkness was setting in and the job was done by torchlight and finally completed with the engine running beautifully.

### View from the roof of Yorks - Tyne Tees. Yes, I do know the roof needs cleaning - any volunteers?



A quick sprint home and we were soon able to tuck into the meal and into the large stock of wine laid on for the occasion. A bit late, but we made it. The lift pump costs 30 quid so no real financial problems either.

All in all it was a successful weekend with all the electronics working well and every single camera surviving well; especially given the weather.

The truck break-down was unfortunate but, hey, it could have been a lot worse (now that reminds me of another story...).

Many thanks to Dave Hill, Richard Harris, Paul Hundy, Jill Marshall, Robert Harvey, Bernard Golland, Sue and Sam Booth and Paul (Kitch) Kitchen.

2011 anybody? Anybody?

## HDMI Versions

Like it or not the HDMI connector is becoming part of our everyday life, but it is a little more complex than previous video connections and here is why. There are currently three types of HDMI connector:

Type A - This is the one that's most common, found on almost all new Digital AV devices. It uses a 19pin connector 13.9 mm by 4.45 mm.

Type B - Is a 29 pin connector, specified for use with dual link DVI-D but in practice seems not to be used.

Type C - This is a smaller connector most commonly called mini-HDMI and is increasingly used on camcorders and other portable AV devices. It also has 19 pins as per type A but measures only 10.42 mm by 2.42 mm.

HDMI is specified with a rather confusing series of numbers, there are different versions for HDMI itself and also for the HDCP copy protection system.

HDMI v1.0 was the launch version (2002) providing for 1080p with digital audio.

HDMI v1.1 added support for DVD Audio.

HDMI v1.2 added support for SACD and provided for better PC connectivity

HDMI v1.2a really marks the time somebody realised it would be a good idea to have this stuff tested and certified to make sure it all works with each other!

HDMI v1.3 increased bandwidth to

10.2Gbps to support forthcoming HD devices with higher frame rates and rather amazingly, provides for over one billion colours. V1.3 also saw the arrival of the mini-HDMI connector, provides for lip-sync error correction and is compatible with Dolby TrueHD & DTS-HD lossless audio.

HDMI v1.3a introduced various minor technical changes for things like timing and capacitance.

HDMI v1.3b included certification for two categories of cable: Standard (category 1) cables are rated to perform up to 75 MHz, which is the equivalent of a 1080i signal. High Speed (category 2) cables are rated to perform up to 340 MHz, currently the highest bandwidth of 1080p signals with increased colour depths and/or increased refresh rates.

HDMI v1.4 adds Ethernet capability.



# AGAF TV-AMATEUR 157

**ATV repeater Hannover online (Wilfried, DJ1WF, on forum.db3om.de)**

For some time now the output of DB0TVH in Hannover is streamed to the internet, the link for VLC-player or Winamp ("media, open network stream") can be found at <http://www.atv-stream.de/cms/>

DL8OBA and DG0CCO are receiving the 13 cm-ATV repeater output and streaming it to the computer center at the High School in Wolfenbuettel, where it is distributed to the net. Sometimes only the tower camera picture is visible, at other times there is interesting talk. Especially our optical (Laser-) ATV input was a worldwide first, meantime there are more ATV repeaters doing or planning it. Another highlight is our annual mobil ATV party - have a good time watching our stream!

**ATV meeting in northern Germany (Rolf, DJ9XF)**

The traditional ATV meeting in northern Germany 2010 was attended by more than 60 OM. The first talk by Rainer, DM2CMB, was about a network testing device for video and rf spectrum measurements. Jens, DH6BB, described the new HAMNET data highway for amateur radio with rf hardware using the 5,7 GHz band, capable of linking broadband data and digital ATV. Achim, DJ0DX, explained the many aspects of our sun, including solar wind, sun spots, flares and CMEs. After lunch Hans, DC8UE, continued his informative talk from last year about video signal processing, aspect ratios and even sound for TV.

The meeting had been announced on the web and in AR news magazines, and a weekly amateur radio bulletin from Berlin by DL5AFN and DL7APN is streamed live online to several ATV repeaters in northern Germany, i.e. DB0DLH (see online link above). But also local print media were present, an important public relations aspect!

**Ballett gala live in 3D (Klaus, DL4KCK)**

On 15th of May 2010 the Eutelsat 3D-TV-Demo channel "3DSatTV" broadcasted live from St. Petersburg (Russia) a ballett gala with russian stars produced in 3D-HDTV. This was a european "first" transmitted free on satellite "Eurobird 9A" at 9 degr. east. The video signal was taken from several Stereo-3D cameras with 2-channel audio, mixed and coded in "Side-by-side"-3D standard, so customary HDTV receivers were able to receive it (and PVRs store it on the internal hard disc). In Moscow and Paris the event was presented on new Samsung 3D television sets (55 inch), and Eutelsat agreed with "General Satellite" to transmit up to 500 hours of more 3D content in the future.

Reception report: on my home cinema screen (3D-ready 720p-beamer Acer H5360) the spatial sensation together with stereo sound is wonderful, only some colored patches are disturbing the left eye channel from time to time. I transfered the "xx.ts" data via FTP from my PVR to the PC hard disk, then the "Stereoscopic Player" from <http://www.3dtv.at> is able to convert the squashed double picture to a 120 Hz page flipping 3D signal together with a modern Nvidia graphics adapter. The 3D beamer is connected via HDMI cable, and the Nvidia "3D Vision" shutter glasses are controlled by an infra-red transmitter connected via USB at the PC (Windows 7 required).

The demo-channel "3DSatTV" on Eurobird 9A was started one year earlier and gives an opportunity to test 3D-TV equipment 24 hours a day. Another "first" was a 3D live transmission from a soccer game in Poland by "Canal+" in May 2010, which was presented in 3D cinemas and to subscribers with 3D TV sets. It was broadcast free on Hotbird 13 degr. east, as well as some time later the first week of "Tennis French Open" from Paris by "orange" - during the second week it was scrambled.

**OE7XZR (Zugspitze) ATV-repeater with a wide range (Guenter Harsch, DL9SA)**

On Wednesday, 10th of March 2010, Manfred, DL2GKM, and me, Guenter, DL9SA, had decided to try to receive the Zugspitze ATV repeater OE7XZR (QTH-Loc. JN57LJ, 2960m ASL). From Reutlingen (near Stuttgart) we traveled to the "Rossberg" mountain 15 km away at QTH-Loc. JN48NK, 868m ASL. Arriving at the parking lot we took our equipment up to the lookout tower 28m high, where we sensed a very cold wind of -5 degrees Celsius, but it felt like -15! Even wearing a cap and gloves it was difficult to screw the cables and devices together and to operate it. As I had assembled my "ATV-suitcase" earlier in preparation to such events we got a fine picture from OE7XZR as soon as we had aligned the 13cm Yagi aerial. One floor down in a wind-protected room with table and chairs we then repeated our trial, and big success! We enjoyed beautiful video on our receiving monitor and stayed a little longer...

The equipment was a short 13cm Yagi, a converter 13 to 23 cm (DG0VE), an analog satellite TV-receiver (Grundig STR-100), a 7 inch LCD monitor and a 12V / 7Ah battery contained in the "ATV-suitcase". The distance to the Zugspitze (highest german mountain) was 177.8 km!

For warming up after descent we enjoyed coffee and cake in the restaurant next to the tower. This "Rossberg-Turm" and the restaurant are open from Wednesday to Sunday with a parking lot only available on weekdays, at weekends there is a parking lot 15 minutes walk away, down the hill. On the tower only commercial aerials are visible, no amateur repeater yet...

Web link: <http://www.schwaebischer-albverein.de/tuerme/rossberg/rossberg.html>

Translations from TV-AMATEUR 157 by Klaus, DL4KCK  
AGAF e.V.

# Contest News

I was pleased to see a good level of activity in the BATC Summerfun 2010 contest. It would be great if we could do the same in the IARU Contest in September! Here are the results:

## 70 CM

Place	Call Sign	Points	Locator	QSO	DX	DX Loc	Km
1	G4TNX/P	208	IO93SO	2	M0DTS/P	IO94LI	92
2	M0DTS/P (Sat)	184	IO94LI	1	G4TNX/P	IO93SO	92
3	M0DTS/P (Sun)	108	IO94MJ	1	G1LPS	IO94EQ	54

## 23 CM

Place	Call Sign	Points	Locator	QSO	DX	DX Loc	Km
1	M0DTS/P (Sat)	2140	IO94LI 5	M0MDY		IO93HH	118
2	G4TNX/P	1358	IO93SO 5	G0DPS/P		IO93AP	99
3	M0DTS/P (Sun)	216	IO94MJ 1	G1LPS		IO94EQ	54
4	G8ACT	170	JO01DT 2	G8IUC		IO91XP	29
5	G0PIA	160	JO01CN2	G8ACT		JO01DT	28

## 13 CM

Place	Call Sign	Points	Locator	QSO	DX	DX Loc	Km
1	G4TNX/P	3530	IO93SO	5	G0DPS/P	IO93AP	99
2	M0DTS/P (Sat)	1910	IO94MJ	2	G0DPS/P	IO93AP	99

## Overall Results

Place	Call Sign	70 CM	23 CM	13 CM	3 CM	Total Points
1	G4TNX/P	208	1358	3530	0	1881
2	M0DTS/P (Sat)	184	2140	1910	0	4234
3	M0DTS/P (Sun)	108	216	0	0	324
4	G8ACT	0	170	0	0	170
5	G0PIA	0	160	0	0	160

I know that Mike G8LES and Nick G4IMO were both active but did not manage any contacts. Also seen in the logs were G0PIA, G8IUC, M0YZA, M0MDY, G1LPS, G0DPS/P, M0IKB, G4FVP/P, G3KJX/P, G7AVU, G7KPM and M0MLJ.

I am somewhat worried that I only received 5 entries considering the level of activity. Please make an effort to

enter the IARU Contest. Paper logs are acceptable – I received one in this contest – but please note my change of address!

Rob M0DTS/P used different locations on Saturday and Sunday and hence has 2 entries. Congratulations to John and his team operating G4TNX/P – a real good effort that just topped Rob's score.

## IARU Region 1 ATV Contest 11/12 September 2010

There has historically been lots of 70cm activity on the continent during the IARU Contest, so don't forget to look out on this band too. The BATC Forum (on the website) can provide you with an indication of who might be active during the contest and is always worth a look.

## Change of Address

Just a short article this issue as I am in the middle of another intercontinental move. Most of my belongings are in customs-induced limbo, and I am due to fly to my new QTH in Abu Dhabi at the end of the month. I will retain the same e-mail address, but my UK mail address will change – see below.

I can be contacted through e-mail (contests@batc.org.uk), or through my BFPO address: Wg Cdr D G Crump, c/o Defence Section, British Embassy Abu Dhabi, BFPO 5413, HA4 6EP, UK.

## Contest Calendar

1800 UTC 11 September 2010 - 1200 UTC 12 September 2010  
- International ATV Contest

1200 UTC 11 December 2010 - 1200 UTC 12 December 2010  
- BATC Repeater Contest

1200 UTC 26 March 2011 - 1200 UTC 27 March 2011  
- BATC Repeater Contest

1200 UTC 11 June 2011 - 1200 UTC 12 June 2011  
- BATC Summer Fun Contest

# The BATC Presidents, Past and Present

2006 - Present incumbent, Peter Blakeborough, G3PYB, CEng, MPhil, MIET

2000 - 2006 Mike H. Cox, CEng, BSc(Eng), FIEE

1991 - 2000 Sir Arthur C Clarke, CBE, BSc, FRSA, FRAS, FBIS

1990 - 1991 Vacant

1981 - 1989 Roger Appleton CEng, MIERE

1977 - 1980 R. C. Hills, Hills BSc(Eng), CEng FIEE, G3HRH

1972 - 1976 R. S. Roberts, FIERE, Sen MIEEE, G6NR

1968 - 1972 Ivan P. James, BSc, CEng, FIEE, FIERE, G5IJ

1964 - 1968 S. N. Watson, MIEE

1960 - 1964 G.B. Townsend, BSc, FInstP, AMIEE

1951 - 1960 Sir Ernest Fisk.

**Sir Ernest Fisk** accepted the position of first honorary president of the BATC in 1951, as reported in CQ-TV 10. Sir Ernest was one of the founding directors of EMI, eventually becoming its Chairman. Before joining EMI he had been with Amalgamated Wireless (Australasia) Ltd, a company set up to develop the patents of both Marconi and Telefunken. His 'roots' in wireless went back to his time from 1906 – 13 as a radio engineer for the Marconi Company.

**Boris Townsend** worked for GEC, whom he joined in 1940. He worked on colour television in the 1950s - building up knowledge of the fundamentals as well as the NTSC system. In 1963, he moved to Rank Cintel in Sydenham, and later became head of the Engineering Research department at ABC Television, before joining the IBA as head of the Engineering Information department. He was author of one of the 'standard texts' on colour television.

**Neville Watson** worked at the BBC Designs Department. He had been engaged on television transmission engineering in the early post war period, but from 1954 to 1957 he was involved with 405 line NTSC colour, with the experimental transmissions from Alexandra Palace after the normal programmes had finished. Subsequently - in the early 1960s – carrying out demonstrations at the EBU to compare the PAL, NTSC and SECAM systems. Neville Watson was particularly concerned that TV receiver design needed to be 'got right', if colour in Europe was not to suffer from the problems experienced with early colour sets in America. He became Chief

Engineer, Television and Designs in 1969

**Ivan James** was one of the pioneering television amateurs. He graduated from the University of Bristol in 1933 and in 1936 joined the Patent Department of EMI Ltd., in Hayes. He was an active radio amateur, and as well as being a BATC president, he later served as president of the Radio Society of Harrow. Professionally, he took part in the development of colour television, working on cameras for EMI, notably the 2001 and 2005.

**Robert (Bob) S Roberts** was author of several technical books, Deputy Head of the Department of Electronics at the Polytechnic of North London (formerly the Northern Polytechnic). He was a pioneer of courses in colour television in the UK in the late 1950s and an active member of the Royal Television Society. He was granted his first amateur call sign in 1927.

**Professor Ray Hills** worked on tropospheric propagation in the UHF band in the mid 1950s for the BBC's work in planning the UHF television networks. This was to minimise co-channel interference with European transmitters. He later joined the ITA [later IBA] at Crawley Court, rising to become Chief Engineer (Transmitters). He was a past Chairman of the IBC Conference Committee and is a visiting professor at De Montfort University.

**Roger Appleton** began his career with the AERE Harwell, moving to the BBC as a technical assistant in 1954, then to Granada's temporary Chelsea Palace Studio in 1957 and to Rediffusion in

the following year. Rising through the engineering hierarchy he became the Chief Engineer at London Weekend Television in 1971 and Engineering Director In 1973.

**Sir Arthur C. Clarke**, as well as being a world famous novelist, also wrote scientific papers. One of the first of these was a proposal describing the possibility of geo-synchronous satellites for radio & television signals. In October 1945 Wireless World published "Extra-Terrestrial Relays" by Arthur C. Clarke. He was knighted in 1998.

**Mike Cox** joined the BATC in 1955 and accepted the honorary presidency in 2000 (CQ-TV 192). Mike started work with Rediffusion studios at Wembley and moved to ABC television at Teddington in 1961, where he was heavily involved in experimental colour development and demonstrations. Mike founded "Michael Cox Electronics" with the Coxbox colour synthesiser and went on to develop a very successful range of studio equipment. Mike joined the IBC management committee in 1988 and became deputy chairman in 1991.

**Peter Blakeborough** trained with the BBC and after 2 years with JBC Jamaica returned to the UK where he joined the new systems group at Link Electronics. They manufactured studio and OB installations for the world market including the BBC type 5 CMCRs and a Thames TV scanner. Peter returned to broadcasting with Yorkshire TV in 1981 where he became the Deputy Chief Engineer with a particular interest in regional news and satellite ENG. A move to Letchworth and Drake Electronics followed. DEL became DAL (Drake Automation) and later ENCODA. UPC Holland and SKY were key projects and directorships followed with both companies. A change of direction into microwave and digital radio systems with Wood & Douglas as a director working with flown and mobile digital services. Peter continues to have television, microwave and millimetric interests and as G3PYB he holds the UK distance record for 76GHz.

# BATC Publications and Members Services

Publications	Each	Qty	Total
<b>An Introduction To Amateur Television (225gm)</b> The latest handbook full of detailed information on how to set up your ATV station, plus lots of new video and RF construction projects. The BATC handbook featuring construction articles on video units, 24cm and 3cm ATV, a Digital Frame Store, and much more.	£2.50	.....	.....
<b>The Best of CQ-TV (150gm)</b> A compilation of the best construction articles from CQ-TV's 133 to 146	£3.50	.....	.....
<b>CQ-TV Back Issues:</b> The following issues are still available. Please circle those required: 185,186,187, 188,189,190,191,192,193,194,195,196,197,198,199,200,201,202,203,204,205,206, 207,208,209,210,211,212,213,214,215,216,217,218,219,220,221,222,223,224, 226, 226, 227	£1.50	.....	.....
<b>Special Offer: Any four of the above issues</b> 228,229,230,231	£5.00 £3.75	..... .....	..... .....
<b>The BATC DVD</b>	£5.00	.....	.....

**All publications can be ordered, with a credit card, via our online shop - [www.batc.org.uk](http://www.batc.org.uk)  
Or by sending a cheque made out to 'BATC'**

*All items appearing in Members Services from previous editions, can still be ordered (subject to availability). Please see page four for contact details. Several items are still on sale, so please check for the latest pricing before sending a cheque.*



[www.nonanet.co.uk](http://www.nonanet.co.uk)  
[sales@nonanet.co.uk](mailto:sales@nonanet.co.uk)

**Nonanet (UK) Limited are a UK Internet Services Provider**

We specialise in providing bespoke hosting solutions, some of our services include:

- Web design & hosting
- Programming
- Consultancy
- Email services
- DNS hosting
- SEO work
- VoIP Services
- Send/Receive text messages from your desktop
- SMS short-codes (premium or standard rate)
- SMS API via SMPP/HTTP/SOAP/Email
- Bespoke SMS services
- Low cost bulk SMS
- Low cost premium route SMS

Contact us on: 01844 220022 or [sales@nonanet.co.uk](mailto:sales@nonanet.co.uk)  
We will provide free hosting services to any project involving ATV  
whether for the individual, club or repeater group  
Contact us for details

# Turning back the pages

A dip into the archives of CQ-TV, looking at the issue of 50 years ago.

## CQ-TV 45

“Now that the Summer season is here again many BATC members will be travelling around the country, and amateur television demonstrations are being organised at several large gatherings”. Following this opening comment, the editor, John Tanner, went on to mention events at Trentham Gardens, near Stoke on Trent, Longleat, Dagenham, Woburn, Manchester and the Radio Hobbies Exhibition in London at which a BATC presence was already planned. The Club also offered to help out with publicity material at other demonstrations arranged by members - and added that reports and photographs for CQ-TV would be welcome. (Still true !!)

A useful note appeared about the phosphors available within cathode ray tubes. At the time, beginners to amateur television often began by making a flying spot scanner, using a 931A photocell to detect the raster scanned on a cathode ray tube (as has been described previously in this series). The choice of crt was determined by the afterglow decay characteristic of the phosphor coating - any afterglow picked up by the photocell would affect the response at higher frequencies of the signal. Some phosphors were made with an extremely short afterglow with flying spot scanning applications in mind, whereas other phosphors were made with long afterglow times - maybe 30 or 40 seconds - for use in radar displays. The white phosphor used for television picture tubes had a medium short afterglow - designed to be just long enough to avoid picture flicker. This meant that television picture tubes were necessarily the best sort to use for flying spot scanning (radar tubes that may have been available as ‘government surplus’ were of no use in this application). The 931A had its maximum response in the blue region. American crt type numbers usually included the phosphor as part of the type number - eg 5FP7 was a 5” round tube with a P7 phosphor. These

were found to be particularly useful for flying spot work, as it had a short persistence blue layer and a yellow longer persistence afterglow. The principle phosphor types are listed in the table below.

The major ‘technical’ article was concerned with ‘colour fundamentals’ - and as valid now as it was then. At the time, it was said that “for the amateur, colour transmission is possibly one of the few worthwhile things left to do in television that has not been done already by the professionals; in Europe at any rate there is still no regular colour television service”.

To transmit colour by television we must be able to measure it, and translate the information into the form of a suitable electrical signal. Now, “as every schoolboy knows”, every colour can be built up from a suitable mixture of suitable primary colours. Notice the word suitable. This is most important - a little carelessness here may land us very quickly in serious trouble. Here’s how - suppose we want to build up a perfect match for a pure colour say in the blue-green region of the spectrum, from a given mixture of red, green and blue. We expect to be able to write out a relation of the form:

$$X = a \text{ parts of red} + b \text{ parts of green} + c \text{ parts of blue.}$$

So far so good. But we may find that in this particular case no amount of fooling about with our coloured lights

will enable us to get a perfect match, though we may be able to get pretty close. However we find out, perhaps by accident, that if we mix a little red light with our unknown, we can match this new mixture quite satisfactorily with a mixture of blue and green. We have, using R, G and B for red, green and blue, that:

$$X + a(R) = b(G) + c(B)$$

and assuming that ordinary algebra applies to this weird and wonderful equation, we write:

$$X = b(G) + c(B) - a(R)$$

which at first sight means that we, need a NEGATIVE amount of red light to add to our positive amounts of blue and green to make a perfect match for the blue-green sample. This is of course nonsense, but in spite of this we know what it means, and we can use these nonsensical equations quite happily. Nevertheless, negative amounts of light in this sort of equation do have a certain nuisance value, but we find that we can minimize the range of colours for which they occur by choosing the primary colours as far apart as possible - hence of course the choice of red, green and blue. These colours are the colours needed to build up the widest range of colours by mixing coloured lights: the more you add, the brighter the mixture becomes, and the 1:1:1 mixture is white, as you would expect. Now here is where the confusion may arise - for films, paints, dyes and so on we have a different set of primaries, the complementary colours of our red green

Type	Colour	Persistence	Use
P1	Green	Medium	Oscilloscope
P2	Green	Very long	
P4	White	Blue component 5mS Yellow component 60mS	Television
P5	Blue	Short	Flying spot scanning
P7	Blue/yellow	Long	Radar
P11	As P5 but less bright with a shorter decay		
P16	Blue-green and ultra violet	UV exceptionally short	
P24	As P15 with extra red		Used for colour slide scanners

and blue - cyan, magenta and yellow. The more of these you add, the darker the mixture becomes, because these pigments operate by reflecting only the wavelengths that make - say - yellow look yellow, and absorbing the rest. Here the mixture with equal quantities of cyan, magenta and yellow will be black.

Back to colour television: it is encouraging to note that colour TV starts out with a considerable advantage over pigments in painting or photography, as far as range of possible colours is concerned. The diagram illustrates this. R, G, B, represent the primary colours red, green and blue, and C, M and Y the "secondary" colours cyan, magenta and yellow, found by mixing equal amounts of the primary colours two at a time. If we mix equal quantities of all three primaries we get a point W representing white, slap in the middle of the triangle, and similarly all the other more or less subtle pinks, pale yellows, creams and oranges can each be represented by its own point somewhere on the diagram. You will see that there is a horseshoe-shaped curve outside the triangle; this is the curve we get if we work out what values of R, G and B we need to match each spectrum, colour in turn, plot these on the diagram, and join them all up, finally joining the ends of the horseshoe with a straight line on which will lie red-blue mixtures like mauve, purple and our old friend magenta, which do not occur in the spectrum. This horseshoe is called the "spectrum locus". All real colours lie on or inside it, just as all the colours we can reproduce from our RGB mixtures lie on or inside the triangle RGB. The area between the triangle and the horseshoe require negative amounts of one or more of our primaries. Since our colour TV receiver uses real primaries which must be always positive (or at worst, zero) we won't be able to reproduce colours outside the triangle, but will reproduce instead a distorted colour on the edge of the triangle, like Z.

In case this worries you, look now at the irregular curve which lies mostly inside the triangle. Inside this curve lie all the ordinary colours that occur in nature, in vegetation or animals, or in the fabrics and materials we normally meet in the TV studio or out of doors, so we have little cause to worry. And because the eye is much more sensitive to, and critical of, slight errors in hue at some parts of the diagram than in others we find we have done rather well, and the apparently large area BXG is not as serious as it looks.

So far we have been quoting the position of a colour on the diagram by quoting the proportions of R, G and B in the colour, but there are two more convenient ways of doing this. At the moment we are only interested in colour and not in the brightness, so we need only specify two of the primaries, as we put white = 1 and so  $R + G + B = 1$  always. In fact we can go better by drawing the whole diagram out on ordinary graph paper and, as usual, quoting coordinates x and y, which are themselves simply related to R, G and B. The other possibility is to use polar coordinates, with white as the obvious place for the origin. Then we can specify any colour we like in terms of the distance of its representative point from the origin, a quantity which we can term the SATURATION or PURITY (zero for white, increasing as the colour moves outward, away from white) and also by stating the direction in which this colour lies from white, with reference to some standard direction. This is an angle of so many degrees, and is called the HUE. All these alternative representations are equivalent, and we can pass freely from one system to another as we please. Notice that however we do it, we need always two quantities to specify the colour. R and B - G is not needed since  $G = 1 - (R+B)$ ; x and y; or hue and saturation. To these two we must add a third signal for luminance or brightness, which may be a perfectly normal black and white television signal, syncs and all. In the NTSC colour television

system, this is done: the brightness information is transmitted as a perfectly normal monochrome TV signal, with the colour information added on an additional carrier. (At the time the article was written, experiments were being done using the NTSC system - the PAL system however follows the same principle of prescribing each colour from its hue and saturation. An understanding of these basic principles is important for colour work, so no apology is made for quoting them at some length).

The only photograph in this edition of CQ-TV adorned the front cover, and showed the 64 element stacked array on top of the tower at Jeremy Royle's, (G3NOX/T) station. The 64 element array was topped by a separate smaller array used for sound, or for reception of vision when the station was acting as a repeater. Jeremy's transmitter ran 150 watts peak white to this impressive aerial system. Not surprisingly, the magazine noted that 'his pictures have been received by many stations in East Anglia and Essex'.

The other items in CQ-TV included news on the availability of scan coils for vidicon cameras, a slow scan counter based on nomotron tubes (a cold-cathode gas decade counter tube - it had 30 cathodes arranged around a central anode disc. Each cathode was connected to one of three external pins, forming ten electrode groups. Sequentially phased pulses were applied to these 3 pins, making the glow discharge jump from one electrode to the next. The tubes when counting would therefore produce a clockwise rotating neon glow - often seen in films of computers of the era), and the customary 'What the Other Chap is Doing' pages - with reports from the Netherlands, Australia, America, Canada and Nigeria, as well as across the UK - from Dave Jones in Totnes to Malcolm Sparrow in Wolverhampton; from Gordon Couzens in West Kirby to Dave Quigley in the Isle of Wight.

**We are still looking for a co-editor. Please contact:  
editor@batc.org.uk if you are interested in helping out.**



Kempston Rally

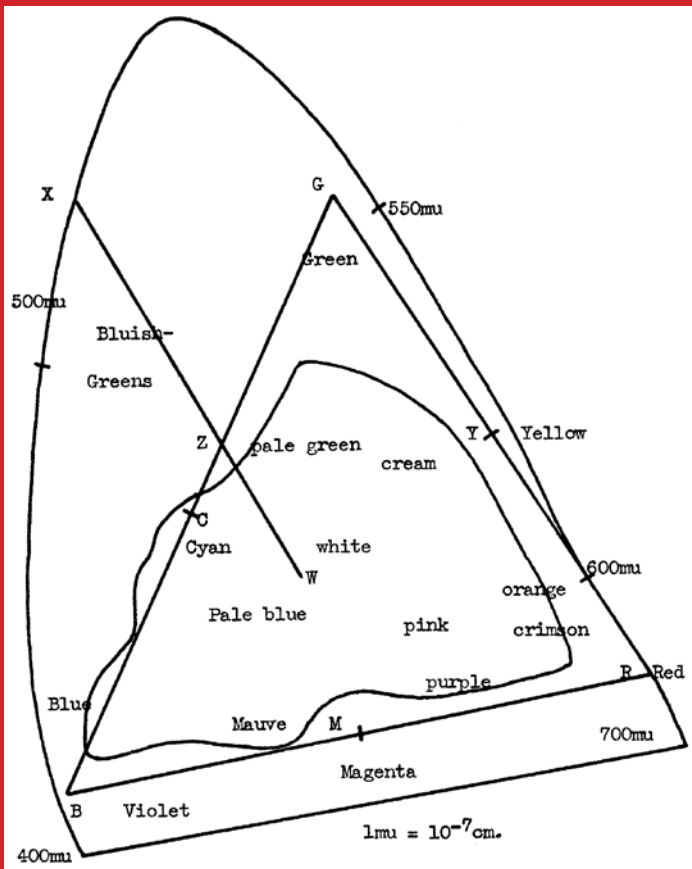



# VHF COMMUNICATIONS MAGAZINE

A publication for the radio amateur worldwide, especially covering VHF, UHF and Microwaves



VHF Communications is a quarterly magazine only available by subscription. The subscription for 2009 is £21.20 which includes UK and surface mail postage. Air mail postage is available at an extra cost.

For more information or to subscribe contact us at the address below or visit [www.vhfcomm.co.uk](http://www.vhfcomm.co.uk)

The web site has sample articles and a full index from 1969 to the present that can be searched to find articles. All back issues are available, most are just £1 plus postage.

Two compilation CDs are available for £10 each plus postage.

CD-1 on measuring techniques contains 21 articles published in VHF Communications magazine from 1988 - 2005.

CD-2 on Transmitters, Receivers, Amplifiers and Ancillaries contains 32 articles published in VHF Communications magazine from 2000 - 2005.

