

# CQ-TV 230

May 2010 - Issue 230

ISSN 1466-6790

www.batec.org.uk



Latest news on the BGM



Project Vivat!  
An update

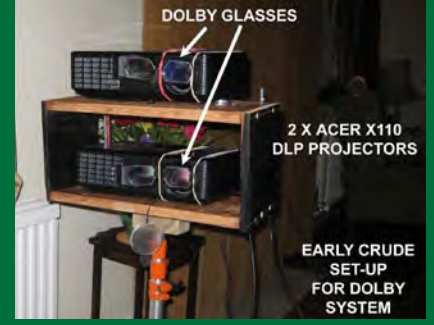

3D Television update

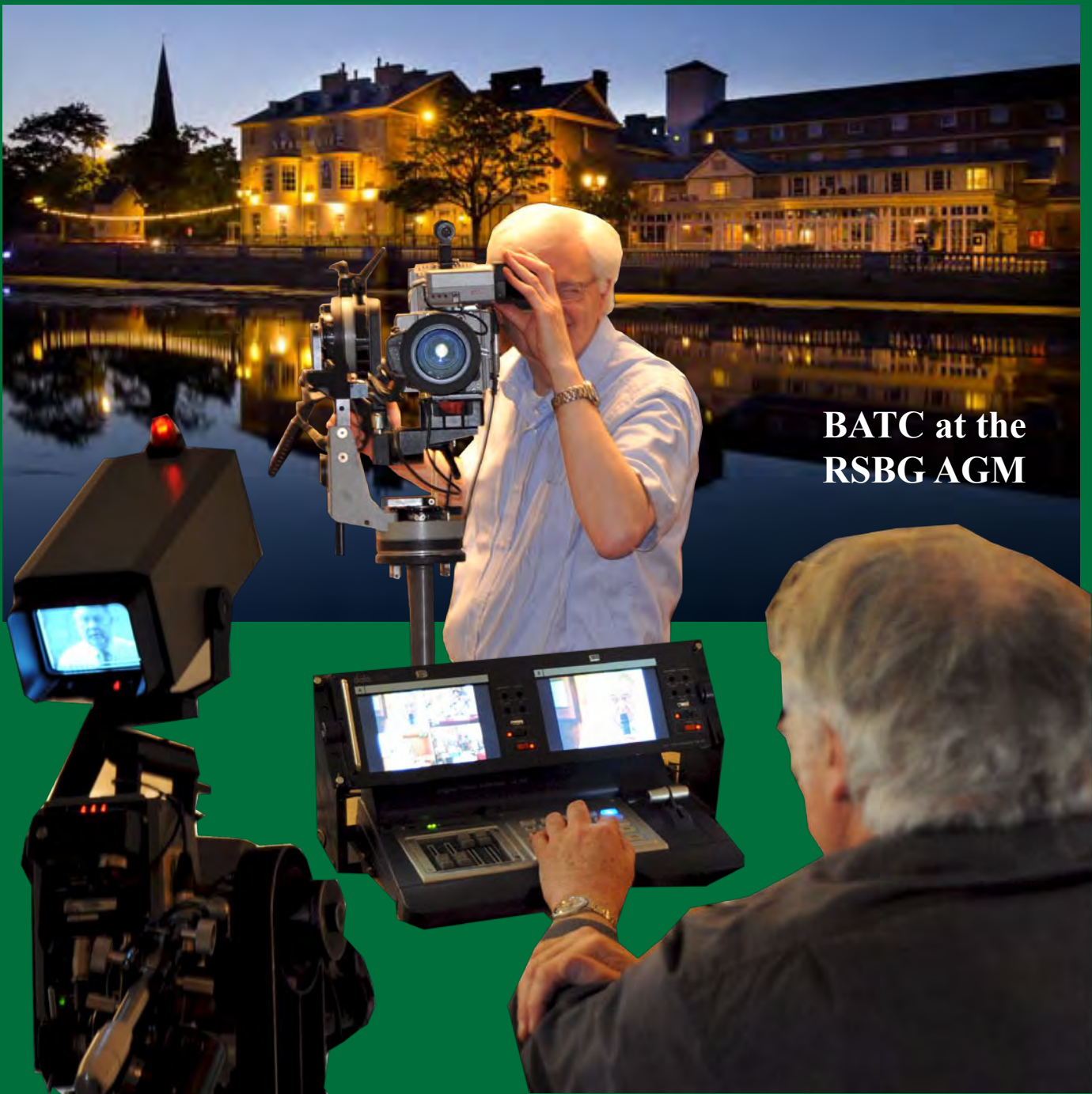

BATC at the RSBG AGM



# Versatile On Screen Display Systems



## PIC On Screen Display Project Board

- Fully programmable
  - I/O for sensor interfaces
  - PIC 16F628A micro
  - User definable fonts
- Demo code for GPS display, 1-wire, cash register & MSF



## GPS video overlay units

Display GPS data on any composite video signal

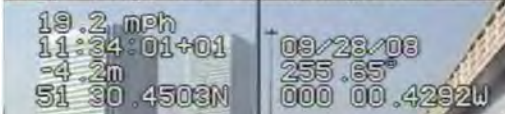

# Visit [www.PIC-OSD.com](http://www.PIC-OSD.com)

The BlackBoxCamera™ Company Ltd. sponsors the CQ-TV caption competition. The winner will receive a keyboard text overlay unit with real time clock.



- 4 text pages
- Real time clock
- Counter input
- PS/2 connection
- UK or US key layout
- Colour / mono video
- PAL and NTSC
- Board only option

## Caption Contest

Here are the entries for last issues picture (shown below), there were too many to fit in the space, so apologies if your entry does not appear::

“When Brian said that he had ordered me a case, I was expecting some wine...”  
Ian Pawson

“Does my bum look big in this?”  
Jules G0NZO & Peter Stonebridge

“What CASE, Which Case?”  
Richard VK4XRL



“How big did you say you wanted the hole for your new ATV tower ?”  
Martin G7MKS

“It was the only way to get a signal over the hill!” - John G0SPE

“When Brian told Pat to get a large bucket to empty the swimming pool look what turned up!” - Viv G1IXE

“.....and behind here is the battery for the roving camera” - Brian G8LYW

...and the winner is Martin G7MKS, congratulations, a caption generator will be on its way shortly.

This months photo is below, comments please to: [editor@batc.org.uk](mailto:editor@batc.org.uk)







# Committee Contacts

**President:** Peter Blakeborough G3PYB  
E-mail: president@batc.org.uk

**Chairman:** Trevor Brown, G8CJS  
Club affairs and Technical queries, especially relating to handbook projects. 14 Stairfoot Close, Adel, Leeds, LS16 8JR. Tel: 01132 670115  
E-mail: chairperson@batc.org.uk

**General Secretary:** Brian Summers, G8GQS  
General club correspondence and business.  
Email: secretary@batc.org.uk

**Hon. Treasurer:** Brian Summers, G8GQS  
Enquiries regarding club finances, donations and constitutional enquiries. 9 Prior Croft Close, Camberley, Surrey, GU15 1DE. Tel: 01276 677879,  
Mobile 077 4029 1191  
Email: treasurer@batc.org.uk

**Membership:** Pat Hellen  
Anything to do with membership, including new applications, queries about new and existing membership, non-receipt of CQ-TV, subscriptions, membership records, etc. The Villa, Plas Panteidal, Aberdyfi, Gwynedd, LL35 0RF, UK. Tel: 01654 767702  
E-mail: memsec@batc.org.uk

**Club Liaison:** Graham Shirville, G3VZV  
Anything of a political nature, co-ordination of ATV Repeater licences. Birdwood, Heath Lane, Aspley Heath, Woburn Sands, MK17 8TN Tel: 01908 282292  
E-mail: g3vzv@amsat.org

**Contests:** Dave Crump, G8GKQ  
Wg Cdr D G Crump, Mailbox ACT, BFPO 63  
Email: contests@batc.org.uk

**CQ-TV:** Chris Smith, G1FEF  
Anything for publication in CQ-TV magazine, except advertising (see below). Email preferred, or by post to: CQ-TV, 89 Wellington Street, Thame, Oxon OX9 3BW  
Tel: 01494 562355  
Email: editor@batc.org.uk

**Members Services:** Chris Smith, G1FEF  
See above for contact details

**CQ-TV Advertising:** Trevor Brown, G8CJS  
14 Stairfoot Close, Adel, Leeds, LS16 8JR.  
Tel: 01132 670115  
Email: adman@batc.org.uk  
Members ads for inclusion in CQ-TV should be sent directly to the editor, either by post or e-mail (see above).

**BATC Webmaster:**  
Anything to do with the BATC web sites  
E-mail: webmaster@batc.org.uk

**Publications:** Paul Marshall  
Handbooks, back copies of CQ-TV and anything related to the supply of BATC publications; Library queries related to the borrowing or donation of written material; Audio & Video archives. Fern House, Church Road, Harby, Nottinghamshire NG23 7ED  
E-mail: publications@batc.org.uk

## Advertising Rates

Size	Mono	Colour
Quarter page	£45	£75
Half page	£90	£125
Full page	£150	£200

**Discounts available for multiple issues.**  
If you would like to advertise in CQ-TV, then please contact our advertising manager: Trevor Brown, 14 Stairfoot Close, Adel, Leeds, LS16 8JR, England. Telephone: +44 (0) 1132 670115.  
Email: adman@batc.org.uk

## Deadlines

CQ-TV is published quarterly in February, May, August and November each year. The deadlines for each issue are as follows: -

February	-	please submit by	December	31st
May	-	please submit by	March	31st
August	-	please submit by	June	30th
November	-	please submit by	September	30th

Please send your contributions in as soon as you can prior to this date. Don't wait for the deadline if you have something to publish as the longer we have your article, the easier it is for us to prepare the page layouts. If you have pictures that you want including in your article, please send them, in the highest possible quality, as separate files. Pictures already embedded in a page are difficult to extract at high quality but if you want to demonstrate your preferred layout, a sample of your finished work with pictures in place is welcomed. Please note the implications of submitting an article which are detailed on the contents page.

# Editors Preamble

## Good news!

For the first time since I took over as editor (again) I have a good surplus of copy for the magazine! Thank you to all who contributed and if your article doesn't appear here, rest assured that it will be in CQ-TV 231.

This edition has some interesting articles at the cutting edge of new technology and techniques; with articles on HDTV, DATV and 3DTV. We also go to the other end of the timeline, with an update on Project Vivat!

The main focus of our Chairpersons column is to remind you all that our BGM is on Sunday 6th June, with a gala dinner on the Saturday evening for those of you lucky enough to be staying overnight. The venue is the Hellidon Lakes hotel - fingers crossed the internet connection holds up this time so we can stream it all at [www.batc.tv](http://www.batc.tv) (although we do have a backup plan in place if not!). I hope to see lots of you there on the Sunday.

## Situations Vacant

My plea for help has unfortunately fallen on deaf ears again, I have had a total of zero people interested in helping to edit the magazine!

Until recently I had a fair bit of spare time on my hands and so editing CQ-TV filled a few spare days each quarter, but recently I find I have more commitments and less spare time. We are also trying to create a more professional magazine, which means more work for those of us that create it.

We could really do with a co-editor to help compile some of the more regular material that we hope to feature, such as the translations from TV-AMATEUR magazine.

You may also have noticed the cover has been a bit more adventurous of late, this is entirely thanks to Trevor, our esteemed Chairperson, who has done a great job on this and the previous edition, but what we

really need is a graphic designer to create the covers. I'm hopeless at all that arty stuff! So if you have artistic tendencies and can manipulate Photoshop (or similar) to create professional magazine covers in electronic format please get in touch, and earn the undying gratitude of your editor, committee and members.

Part of the reason why I need help with the magazine is that I am trying to free up some time to do some coding work on the streamer website. We also have an ongoing project to bring more services online for the members in general. So helping me with the magazine is in everyone's best interests.

I look forward to hearing from some of you regarding the above as well as receiving lots of letters, emails and articles for publication.

Enjoy CQ-TV 230

Chris Smith - G1FEF  
[editor@batc.org.uk](mailto:editor@batc.org.uk)



We have produced a DVD containing electronic versions of CQ-TV and the CQ-TV articles index. Also included are electronic versions of our three most recent handbooks, 'Slow Scan Television Explained', 'Amateur Television Handbook' and 'An Introduction to Amateur Television' as well as the Lighting eBook.

The archive contains all past issues of CQ-TV and is updated 4 times a year, to include the current issue of CQ-TV.

The DVD is playable in a standard (domestic) DVD player (and on a PC with a DVD player) and the data files will 'auto-run' when the DVD is put into a PC.

The video section was prepared by Brian Kelly and contains videos from Bletchley Park 1999, one from Shuttleworth 2002 and one from 2004. The DVD is available to members for just £5 inc. postage to the UK and EEC.

[http://www.batc.org.uk/club\\_stuff/pubs.html](http://www.batc.org.uk/club_stuff/pubs.html)

Note: This DVD is supplied on +R media only.

# Chairman's Column



Yes it's that time already, and we are holding the BGM at the Hellidon lakes hotel, the same venue that we used last year for the 60th birthday. The Official BGM meeting is at 2.30 on Sunday 6th of June and is a chance to elect a committee to run the club for the next two years.

It's a long way to come just to elect a committee, see the accounts and ask questions, so we are going to fill the day with a lecture programme organised by Noel Matthews which is shown below.

There will also be a separate room for a small flea market, with potentially a couple of small traders, so bring along all that interesting kit you've got in garage for years and never got round to using – someone else just might and pay the commission to the BATC instead of ebay!

There will also be an area set aside for table top demonstrations / presentations

where you, the members can bring along your interesting projects and tell others about it. We've already had a couple ideas such as a live demo of remote station control over the internet and 70cms DATV promised, but have room for plenty more.

The event will be streamed and it will be possible to see and use the BATC's mobile studio in action along with a couple of member's ATV vehicles which will be parked outside and in action all day long.

We are planning a really interesting day on Sunday and if you any comments or ideas, please contact Noel (G8GTZ) or Peter (G3PYB) with your feedback.

## How to find the Hellidon Lakes Hotel

### BY ROAD

From the M1

Exit at Junction 16 and take the A45 towards Daventry. After approximately 8 miles take the A361 towards Banbury. Approximately 5 miles from Daventry (just before Charwelton) turn right towards Hellidon and Priors Marston. After approximately 2.2 miles take the second turning on the right towards Hellidon. The hotel is on the left.

From the M40

Leave at Junction 11 (Banbury) and take the A361 towards Daventry. Approximately 11 miles from Banbury, just after passing Charwelton, turn left towards Hellidon and Priors Marston. After approximately 2.2 miles take the second turning on the right towards Hellidon. The hotel is on the left.

### BY RAIL

Rugby – 19 miles.  
Northampton – 17 miles.

### BY AIR

Birmingham International – 31 miles.  
Heathrow – 80 miles.







Last years gala dinner

05/06/10 TO 05/06/10: 3 COURSE DINNER £29.95 PP

You can book via central reservations (845 074 0030) and quote BATC to get the rates below for Saturday the 5th of June. Its Telephone bookings only.

Hellidon Lakes  
Hellidon  
Daventry  
Northamptonshire  
NN11 6GG

Telephone: 01327 262550  
Fax: 01327 262559

#### BATC Room Rates:

05/06/10 TO 05/06/10: B&B SINGLE OCCUPANCY £75.00 PPPN

05/06/10 TO 05/06/10: B&B DOUBLE/TWIN OCCUPANCY £85.00 PRPN

9:30	Welcome and introduction to the day	
9:30 – 10:00	What's happening in ATV – an update on UK ATV including DATV activities and repeaters	Peter Blakeborough - G3PYB
10:00 – 10:30	An overview of digital TV trends looking at DVB S2, MPEG-4 and HD	Noel Matthews – G8GTZ
10:30 – 11:00	Coffee break	
11:00 – 11:30	An introduction to 3D TV	Noel Matthews – G8GTZ
11:30 – 12:00	3D technologies in detail	Mike Cox
12:00 – 12:30	DATV in practice	TBA
12:30 – 12:45	BATC streaming – an overview of the site, technology and activities	Chris Smith - G1FEF
12:45 – 1:00	BATC streaming – how to start streaming your ATV station to the world! (Practical session continued over lunch)	Trevor Brown - G8CJS
1:00 – 2:30	Lunch	
2:30	BGM	

## ATV Newsletter

The ATV Newsletter is a weekly publication covering World ATV News that I find interesting as well as events, projects and activities sent to me by my readers. You also get the latest Local ATV News from the repeater networks here in Southern California. And it's free. Plus information on Digital-ATV/ATV GUIDE, for weekly scheduled ATV events via Streaming Video/ATV Website Links/and more. To subscribe send me an email with your first name and call to [atv-newsletter@hotmail.com](mailto:atv-newsletter@hotmail.com) and I will add you to the mailing list. You can also include any info about your ATV activities in your email, if you wish. I just might put it in the newsletter!

Bryon Foster - N6IFU (Editor & Publisher of the ATV Newsletter)

# Circuit Notebook 104

by John Lawrence GW3JGA

## Automatic Video/Audio Switch

In February 2010 Repeater GB3TM on the coast of Anglesey was up-graded to include a digital DVB-S output on 23cms as an alternative to the existing analogue one. The change-over between analogue and digital outputs is controlled by a DTMF tone on the incoming audio (Key 1 for digital, Key 2 for analogue).

The repeater transmits analogue TV in beacon mode, which is the fall-back condition. Once switched to digital output it continues in this mode for 15 minutes before returning to analogue. It can be switched between either at any time.

Streaming the output of the repeater is done by receiving the signal at my home (a 37 mile path), converting the video and sound in my PC and then sending it on line to the BATC server. I receive the signal from the repeater on two receivers simultaneously, a Comac SL25/12 for DVB-S and a Maspro for analogue. While I am in the shack I can manually switch between the outputs of the two receivers depending on which signal mode is being transmitted. I needed an automatic switch which would automatically select the valid signal.

It is not possible to detect whether or not a digital signal is present by monitoring the video output of the digital receiver as it continues to output a 'no signal' caption, so there is a video output at all

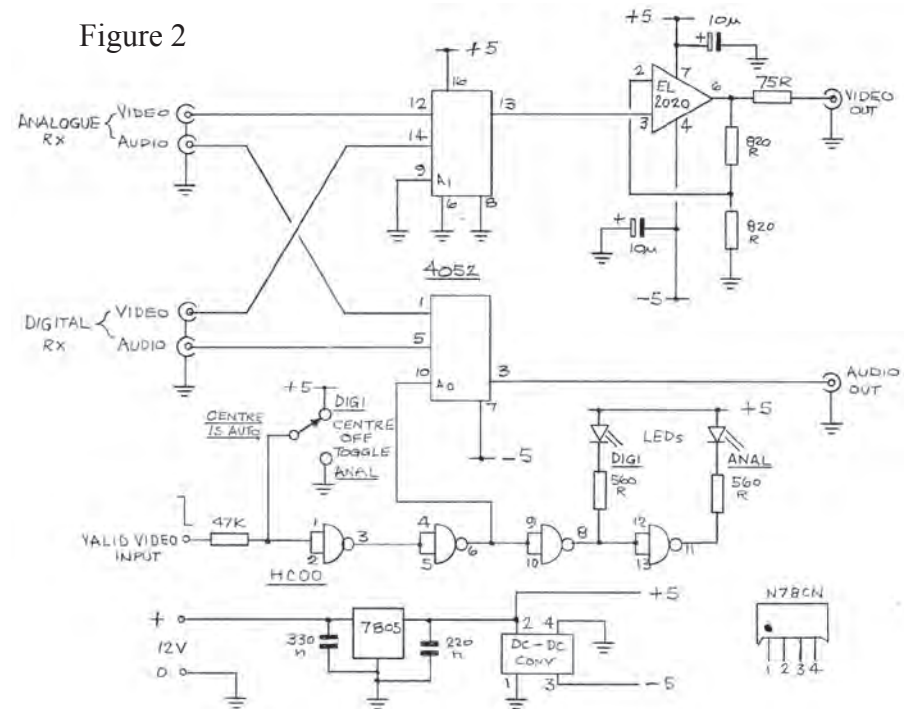

Figure 2

times. On the other hand, the Maspro analogue satellite receiver outputs noise in the absence of a valid signal and normal video when a signal is present. The detection of this condition is used to select the correct video signal to be output.

The detection is performed by a video detector circuit, first described in Circuit Notebook No. 83, CQ-TV 204, November 2003.

The block diagram in Fig.1. shows the basic arrangement of the detector and change-over switch. The outputs of the two separate receivers are taken to the change-over arrangement using two channels of both sections of a 4052 (Dual 4-Channel analogue multiplexer/

demultiplexer), one section is used for video and one for audio. If the repeater transmission is analogue then the analogue receiver produces a 'valid' video output. This is detected and the multiplexer is switched to the analogue receiver. If the analogue video output is missing (digital is being transmitted) then, in principle, the output from the digital receiver will be present, so the multiplexer is switched to this receiver. This means that no matter which mode of transmission is used from the repeater there will be a valid signal available for viewing or streaming without the need to constantly monitor both signals and switch over manually.

The circuit of the video/audio switch is given in Fig.2. The upper half of the 4052 carries the video signals and feeds into the usual X2 video amplifier with 75R sending resistor using the familiar EL2020 video op-amp. The lower half carries the audio signals. The valid input signal (logic low) from the signal detector is taken to the string of NAND gates provided by the HC00. The 'HC' version is used because of its high input impedance and its output current capability, suitable for driving LEDs. The input is connected to the 'valid' detector through a 4k7 resistor.

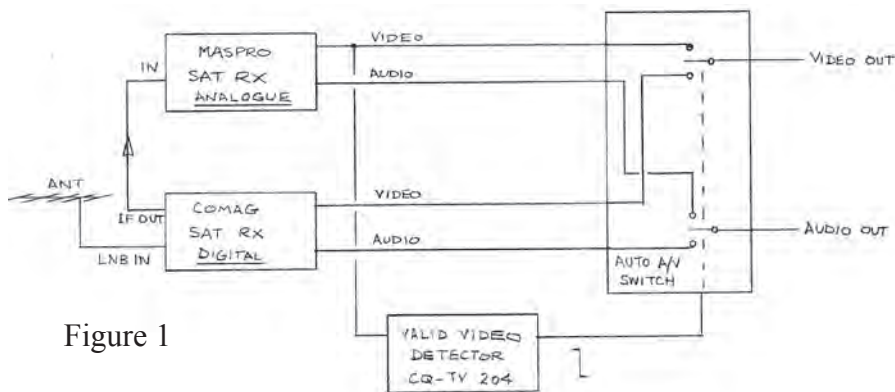

Figure 1



This allows a 'centre-off' toggle switch to be used to override the input signal and allow analogue or digital inputs to be selected manually.

The Veroboard layout for the switching unit is shown in Fig.3. and a picture of the completed board is shown in Fig.4. The video detector Veroboard(from CQ-TV 204) and the video/audio switching Veroboard are mounted side-by-side in a die-cast box, shown in Fig.5. Phono connectors for inputs and output are on the back edge and LED indicators and the manual over-ride switch on the front.

The power supply arrangements are conventional, with a 12V d.c. input fed to a 7805 regulator to provide +5V. This is converted by a 5V-5V d.c.-d.c. converter (Maplin N78CN) connected so as to produce a -5V supply for the 4052 and the EL2020. The 7805 is fitted to the inside of the die-cast box housing the kit. All other components are fitted to the Veroboard.

So far, the unit has performed well and as more use is made of the dual-standard output of the repeater GB3TM it will become an essential piece of kit in the GW3JGA shack.

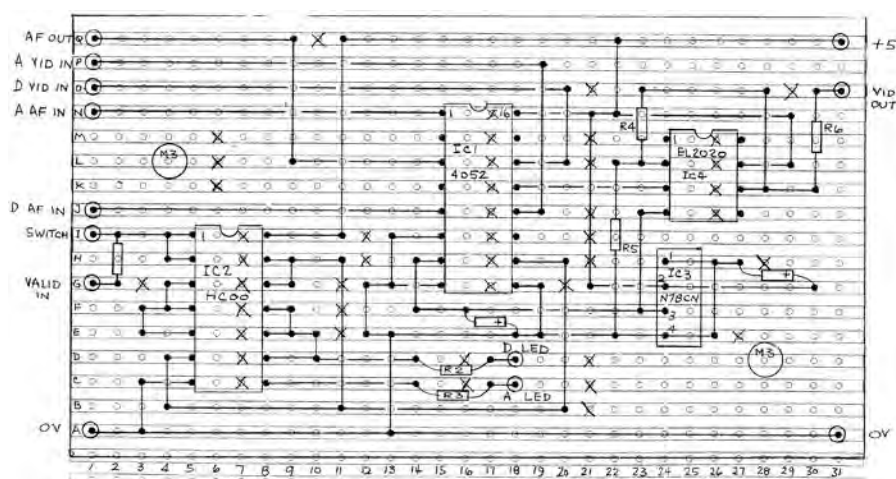

Figure 3

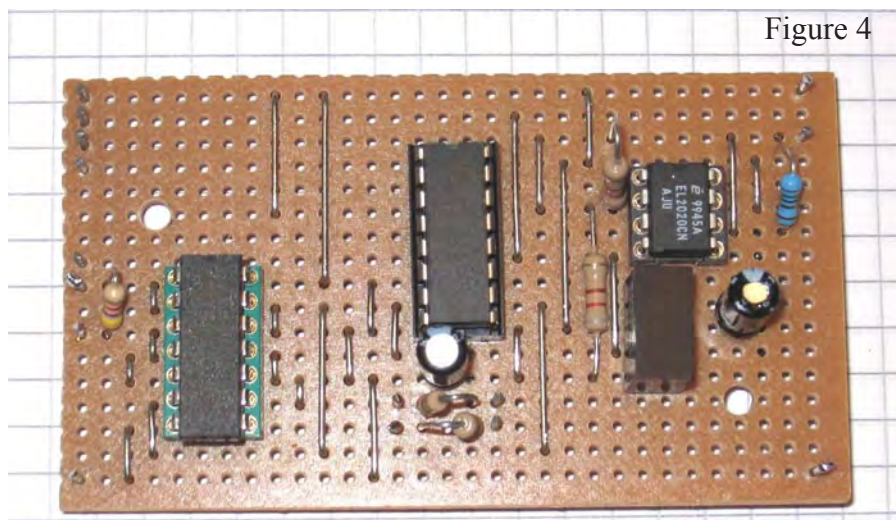

Figure 4

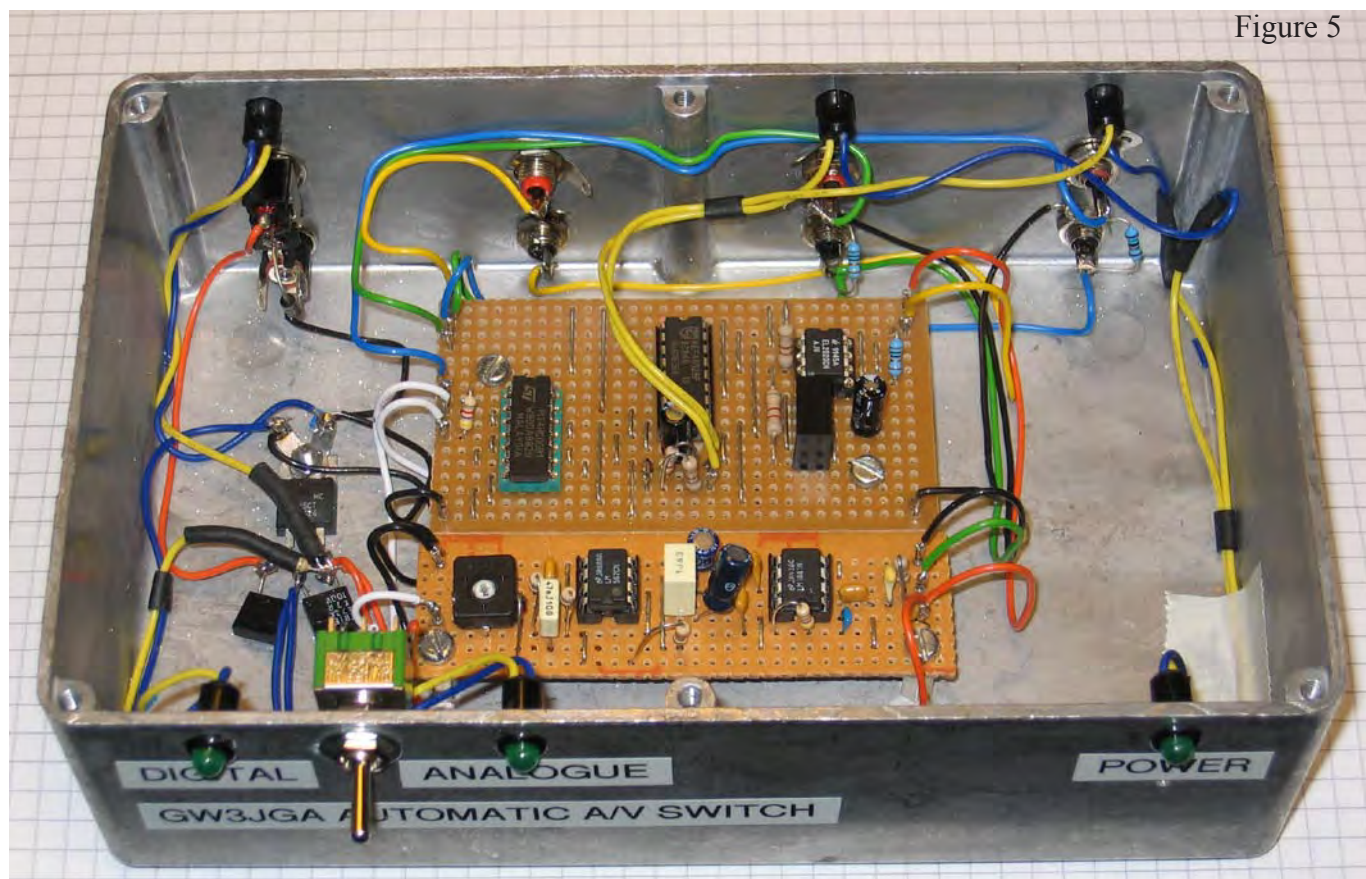

Figure 5



# The RSGB 2010 AGM

by Trevor Brown G8CJS

17 of April was the date for RSGB 2010 AGM and this year it was held at the Swan hotel Bedford. BATC were asked again if they would stream both the AGM and the Open Forum. Normal standard operating procedure prevailed and we did nothing until the week before and then panicked.

Brian Summers offered to help and bring along two elderly LDK90 cameras, Richard Harris provided lighting, Paul Pitts and yours truly travelled down from Leeds (4.30 am start). It's always interesting to reflect on things after the event, let's wind the clock back and see it in chronological order:

## Event Day minus 14

The video to USB converter had presented audio problems last time out so I thought we might replace it, trip down to Maplins store revealed they started at £30, so I ordered one from the internet for £6

## Event Day minus 12

Email arrived to say the converters were on 7 to 14 days delivery

## Event Day minus 10

Help! can we borrow one, Bob Robson responded and put his in the post from South Wales, not sure how the Royal Mail works in South Wales but it's now Event day +5 and it still has not arrived

## Event Day minus 7

I considered taking the home PC which has firewire (IEEE 1394) input, the DVR that we were going to record the event on had Video and Audio in and firewire out. The idea of the VTR is to make a higher resolution copy of the days events so they can be put in the streamer library, a few engineering checks and the system worked. The main worry was the home PC does not have Wi-Fi so the system depends heavily on the Internet socket at the hotel checked earlier by Graham Shirville and Giles Read, a laptop would be better, but not many have fire wire.

## Event Day minus 5

Paul offered the loan of his USB adaptor and duly delivered it, fine on pictures but no audio, I suspected driver issues as they were downloaded from the net

## Event Day minus 3

Paul finds the driver disc, drivers installed still no audio. Backup plan 2 use the laptop mic input and construct an attenuator so that line level can be fed into the laptops mic input, most laptop PC's have only a mic input so large pads are the order of the day, but they always sound thin and compressor pumping can often be heard.

## Event Day minus 2

Start putting the BVP7 Sony camera together, the club mixer has 4 inputs so 3 cameras and the PC to video adaptor



for Power Point and all inputs are in use. Meanwhile Brian Summers is building a cue light driver interface for the clubs SE 500 mixer, so cameras will know when they are selected for mixer line output.

## Event Day minus 1

The mail ordered USB Audio Adaptor arrives, drivers loaded and still no sound when used with the Adobe Live Media encoder software. Is it just me or has anyone else met this problem? Midnight oil and frantic email time. Brian Summers gets the club USB adaptor working but again no audio, but the laptop he is using has fire wire, bring it along and we will connect it to the recording VT. Just enough time to create some graphics, email them to Brian to put on SD card and check them with the slide converter that is now part of the streamer kit. Midnight and it looks like the 4.30 start might be a problem, SMS to Paul who is traveling down with me, dare not ring him with the start time. Load the car with leads Recorder and Sony camera, and try for a few hours sleep.

## Event Day arrives

Nobody more surprised than me to find Paul on my drive at 4.30am complete with tools and a collection of bits and bobs we might just need. Arrive at the Swan Hotel, Bedford at 7.30am to be greeted by an anxious Giles, he had lots of questions but I had only one "where's the coffee?" 8 am Brian and Richard, the local crew arrive. Time to plan the camera positions, and start the wiring. By 11am the cameras were working, the mixer recorder and internet connection via the E to E connection of the VT all working, almost back patting time but







then the Sony camera packed up. The aperture corrector board, with its useful bypass switch, (or so we thought,) might save the day. The RSGB had delegated all the sound coverage to an outside contractor so we assumed all we needed to do was connect to their desk, in the mistaken belief that all the delegates asking questions from the floor would be amply covered with roving microphones.

### AGM minus 10mins

Mains breaker fails and we lost one light and the sound mixer, quick re-plug of the sound desk mains and we were forced to continue with only one light.

### AGM on AIR

Initially some of our Internet viewers used BATC's return messaging service to alert us to occasional sound breakup. We duly reduced the bit rate and this was soon cured. Sorry for the short break in transmission to the Internet but you cannot make adjustments to the streaming rates without interrupting the flow! The VT feed was not affected so the copy in the archive has the 'missing' 40 seconds. The AGM coverage went well apart from the contributors that spoke without microphones, particularly the board of directors! Sorry but beyond our control as they say in the best television circles. The cue lights did give up the ghost at one point, these were only wired to the LDK 90 cameras and there was some inevitable confusion to which camera was on air. We had almost made it through the award presentation when the Sony camera started delivering green pictures and failed to respond to any amount of TLC, again see the archive copy.

Paul managed to scramble his handy cam into service, (complete with date in vision before we spotted it,) for the conclusion of the RSGB's AGM.

```

LED A3 = pin 1 = 1R (Main1)
LED A2 = pin 2 = 1G
LED A1 = pin 3 = 1Y (Sub1)
Ground = pin 4 = GND
LED D3 = pin 5 = 4R (Main4)
LED B3 = pin 6 = 2R (MAIN2)
LED B2 = pin 7 = 2G
LED B1 = pin 8 = 2Y (Sub2)
Ground = pin 9 = GND
LED D2 = pin 10 = 4G
LED C3 = pin 11 = 3R (Main3)
LED C2 = pin 12 = 3G
LED C1 = pin 13 = 3Y (Sub3)
Ground = pin 14 = GND
LED D1 = pin 15 = 4Y (Sub4)

```

Video Channel	Red LED (On Air)	Green LED (Off line)	Yellow LED (Next)
1	Pin 1	Pin 2	Pin 3
2	Pin 6	Pin 7	Pin 8
3	Pin 11	Pin 12	Pin 13
4	Pin 5	Pin 10	Pin 15

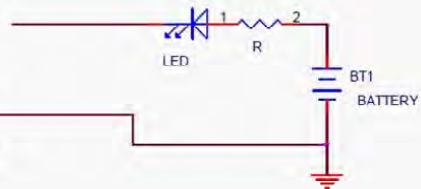
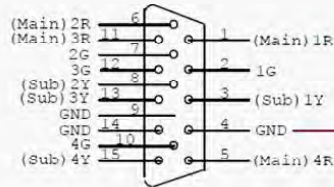

### Lunch Time

Look at the Sony Camera, change batteries in cue light box, check the tapes, read the streamer text to see if there were any problems, reposition cameras for audience shots, oh yes eat lunch too

### Open Forum

Tape change and off we went into Open Forum. This is always a little more difficult, finding speakers in the audience and getting shots. The cue lights had momentarily reappeared and died, the Sony camera refused to deliver anything but green pictures, so it was two camera's and a handy cam, but apart from speakers who proceeded without microphones, I think Carlos was the worst offender, we got through it. Again the completed event can be seen on the batc.tv website. My thanks to Paul, Richard, Brian and Giles. My thanks to the RSGB's General Manager, Peter Kirby, for the challenge. I hope all the viewers enjoyed our efforts and a special thanks to Giles for the photographs.

### Event Day plus 5

The next stage was to sort the problems. The BGM is probably the next time we need the mixer but thing have a habit of creeping up on you, so I thought I would start with some better cues and hopefully come up with something a little more professional now the immediate pressure is off.

The temporary tally cue box used relay which is common practice in broadcast, but we had only had lights on two cameras as some of the cue outputs from

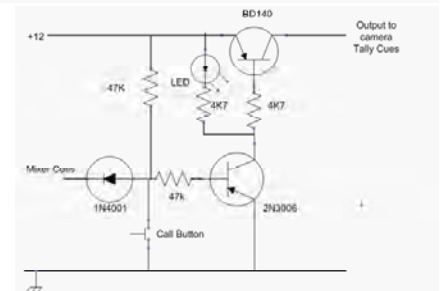

the mixer would not perform for Brian, slightly worrying as our mixer was a £600+ purchase. The manual shows all the connections, but is a little woolly on the interface is it an open collector or good old relay contacts, if it is open collector what current can it sync, it's also a confusing diagram as pin1 is on the long side of the VGA connector

A little time with the mixer and a meter reveals go with the pin numbers not the diagram

Lets ignore yellow tallies they are not very common in the UK, they only inform the camera operator that his camera has been selected on the preview bank, fine if the vision mixer operator always previews your camera before cutting to you but in the real world this does not always happen.

Brian Kelly came up with an electronic switch to deliver +12volts to the camera from a logic 0 on the mixer output. We added a camera call Button so that the cue tally's could be manually tested to try and isolate problems on site and to be able to check the correct cue is connected to the correct channel without switching on the mixer which may be on line with a caption prior to the commencement of the event.

The cues are carried to the mixer via 3 pin XLR connectors, as per the original, leaving one spare wire to each camera for one way talkback from the mixer to the cameras. The cues are on pin 2 the talkback on pin 1 and cable the common ground on pin 1. The sockets on the box are female.

I hope this is sufficient information for anyone bringing a camera equipped with cues and or talkback to any of our events to be able to engineer the connections so its plug and play on site

### Event Day plus ∞

The next stage of evolution is to add some onsite recording capacity to the mobile studio, at the moment this relies on myself or Peter Blakeborough bringing along a personal digital tape recorder.

DataVideo the people who make our mixer do a range of hard disc recorders which compliment our mixer

<http://www.bhphotovideo.com/bnh/controller/home?O=productlist&sku=532340&Q=&is=REG&A=details>

<http://www.datavideo.info/en/Recorders/DN-500>



Blackmagic Card

[http://www.google.co.uk/products?hl=en&q=datavideo+dn+400&um=1&ie=UTF-8&ei=skzdS7vzFZTu0wSv972\\_Bw&sa=X&oi=product\\_result\\_group&ct=title&resnum=3&ved=0CCMQrQQwAg](http://www.google.co.uk/products?hl=en&q=datavideo+dn+400&um=1&ie=UTF-8&ei=skzdS7vzFZTu0wSv972_Bw&sa=X&oi=product_result_group&ct=title&resnum=3&ved=0CCMQrQQwAg)

add these costs to a streaming computer, and its serious money. If we don't record on site we are not protected against internet failures, and we don't have a copy for the library, once the streaming is over there is nothing left, is there a way to work around these problems I believe so...

We can convert a humble PC into a hard disc video recorder by the addition of a Black Magic Video card

[http://www.videoediting-direct.co.uk/product\\_44018/Blackmagic\\_Intensity\\_Pro](http://www.videoediting-direct.co.uk/product_44018/Blackmagic_Intensity_Pro)

But we still need a streaming PC, so that's two PC's two copies of windows or do we

Test so far confirm that a PC can indeed be transformed into a video recorder. Could the same PC then video stream? well yes and no. Providing it has a CPU which can cope with both tasks yes, but no the Black Magic video card will not supply two applications at the same time I.E. the streaming software (Adobe live media encoder), and the Black magic software that drives the intensity pro video card, but if we add a Video to USB or Video to firewire converter and use this for the streaming and use the intensity pro card for the onsite recording then this may be possible Its early days yet, but so far the experiments are encouraging.



# VHF COMMUNICATIONS MAGAZINE



A publication for the radio amateur worldwide, especially covering VHF, UHF and Microwaves

VHF Communications is a quarterly magazine only available by subscription. The subscription for 2009 is £21.20 which includes UK and surface mail postage. Air mail postage is available at an extra cost.

For more information or to subscribe contact us at the address below or visit [www.vhfcomm.co.uk](http://www.vhfcomm.co.uk)

The web site has sample articles and a full index from 1969 to the present that can be searched to find articles. All back issues are available, most are just £1 plus postage.

Two compilation CDs are available for £10 each plus postage.

CD-1 on measuring techniques contains 21 articles published in VHF Communications magazine from 1988 - 2005.

CD-2 on Transmitters, Receivers, Amplifiers and Ancillaries contains 32 articles published in VHF Communications magazine from 2000 - 2005.

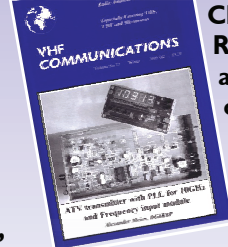
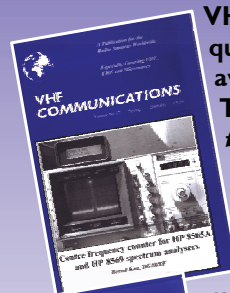

K M Publications, 63 Ringwood Road, Luton, Beds, LU2 7BG, UK. Tel/Fax: +44 (0) 1582 581051, email: [andy@vhfcomm.co.uk](mailto:andy@vhfcomm.co.uk)



# Project Vivat! Update

by Paul Marshall

Firstly, many thanks to all the people who have responded so favourably to news of this project as revealed in the last issue of CQTV. I've had emails not only from up and down this country, but from as far afield as Australia and the USA. It's not just been emails but offers of help and equipment, some of which have already been acted upon. We now have two suitable AVRs, thanks to Ian Waters for one and to Jeffrey Borinsky for arranging the second. Other items include a lovely mobile cased Marconi 405 line Monoscope Camera from Mark Killingback, and a Marconi Waveform Monitor, also in a mobile case from Dicky Howett. Two items have been found on eBay, one a period Heayberd battery charger and the other a lovely Punch cartoon from 1953 illustrating 'Elizabethan' television. The cartoon reflects upon BBC Television's Elizabethan Evening, aired in 1953, imagining what television might have been like if it had been around in the time of the first Queen Elizabeth. Still looking for the BD841N vision mixer and a BD813 LCA (Line Clamp Amplifier) though . . .

So, that's the general situation, but what's been happening on the technical front? It's largely been a time for exploratory restorations carried out to gauge how big a task all of this will be, at least from an electronics perspective.

## Restoration experiments

I needed to know just how much electronic restoration work was going to be required on this project, and even if it was in the land of possibility. In the last four months I have embarked upon a trial examination of just how much electronic restoration work will be required when carried out without pressure. Whilst I have had many years experience of restoring vintage television equipment of all ages and types it has invariably been against the clock, rushing for some event or programme. This has led to a pretty ad hoc approach without much 'method' other than standard fault



finding techniques, albeit on a fairly grand scale. Can a formal 'method' be applied to this kind of work?

It is in the nature of analogue electronic equipment to degrade gracefully with a notionally 'fully working' older piece of equipment still having dozens of minor faults. Then along comes a catastrophic failure and it falls into the 'non-working' category. If the equipment is unlucky, it will then become the source of spares to keep

other items going. The final blow is then to be thrown into a damp garage or shed and forgotten about for years, adding further to the fault list from damage due to dampness. Then, sometimes, people like me come along and attempt to repair it, starting with cleaning, then replacing the obviously missing parts, moving on to slowly running up the gear, mending that catastrophic fault (occasionally there isn't one!) and then finally slogging through the great long list of minor issues. Well, that's how it usually works, but with 60 year old kit the situation is further muddled by gross long term component failures simply due to age. Electrolytic capacitors, carbon composition resistors, damp infested wire wound resistors, damp damaged wound components, leaking inter-stage coupling capacitors and many other generic faults then make the whole restoration process a daunting prospect. Is this project viable, or has the equipment passed into an era that is realistically beyond reclaim?

Three items were selected as a control test: a totally unknown complex picture monitor, a previously working waveform monitor and a long abandoned but well stored newly acquired monoscope camera. The latter two pieces of equipment I already knew fairly well from previous restoration projects, but I



hadn't seen a picture monitor of that type for almost 35 years. I'd failed to mend that one all those years ago - my excuse is that I was young, inexperienced and I didn't have the circuit diagram then!

#### Case 1: Marconi BD810 Waveform Monitor

This unit had already had some restoration work carried out and had been working in recent years, albeit only to a limited degree. Previous restoration (not by me) had primarily centred on the Y output stages comprised of a pair of 5763s and associated components. In addition, some work had been done on the self oscillating EHT supply with its Visconol capacitors having been replaced along with certain resistors. After powering up using a variac it was immediately apparent that the main HT smoothing capacitor was completely open circuit, despite showing no signs of physical distress. A genuine new old stock replacement produced a trace, of sorts. Cutting a long story short, every single Dubilier metal foil capacitor had to be replaced in order to achieve some semblance of proper operation of the stabilised HT power unit, the X timebase system, the Y input and X output stages. Due to the leaks in the metal foil capacitors destroying DC working conditions, two wirewound anode load resistors in the X and Y output stages had to be replaced along with two 5763 valves damaged due to excess anode current. The resulting trace is bright, linear and after switch and potentiometer cleaning the unit is

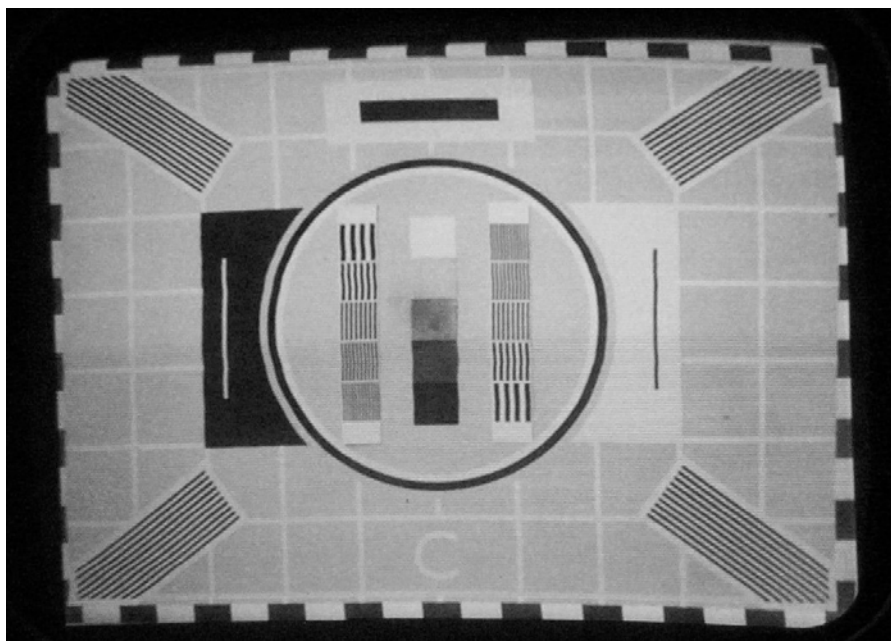

essentially fit for duty subject to some tidying work.

Time taken: about 15 hours, including searching for spares!

#### Case 2: Marconi BD 617B 405 line Monoscope Camera

Although having been stored warm and dry in recent years this example had not been powered for a very long time. Only very limited repair work from the past was evident with very few 'foreign' components or signs of soldering work. Having learned from the Waveform Monitor that the Dubilier capacitors were likely to all be faulty a decision was taken to simply replace all of them, checking them for evidence of leakage on a Megger in order to gauge

whether this global swap out was really necessary. It was – every single Dubilier capacitor was showing terrible leakage, even using a digital multimeter, which, of course, does not present the same voltage stress as a Megger. Resistances of a few megohms were common, some being less than 100K ohm. Powering up using the variac again most of the units sub-systems burst into life and after the replacement of a couple of faulty valves, a Visconol capacitor and a few small resistors an image of Test Card C appeared on the test monitor. It has a very tiny centre of image burn mark, but other than that the tube appears to be in good order. One fault remains – a curious gamma law causing the image to be slightly white crushed. It appears to be leaving the tube with this gamma – there is no gamma correction in the video processing and an injected grey scale image passes through without impairment. Not a serious problem, but I would like to know what's going on. Tube emission, perhaps?

Time taken: about 12 hours.

#### Case 3: Marconi BD 819A 405 line Picture Monitor

The example to be restored was made in 1952 when the design was pretty fresh out of the design labs. The manual seems to have a lot of documented mods, but the monitor itself appeared to be pretty much complete and fairly up to date according to its mod state record. The design is very complex for its age having regulated HT, stabilised





bias and regulated EHT supplies. In addition it has switchable sync tip/back porch video clamping, a complex multi stage clamped frame scan and dynamic focus (horizontal and vertical). The tube is a 14" ion trap type having permanent magnet focusing with the dynamic focus added via a large focus coil. Quite a fearsome beast of a monitor!

Once the basic HT and bias power supply faults were fixed (o/c wirewounds, duff gas filled stabiliser valve and leaking Dubiliers, but no electrolytic capacitors, not one), the rest of the stages were tackled one by one. Having learned from the monoscope and the waveform monitors attention turned directly to the Dubilier capacitors of which there were dozens. Removal and checking with a Megger showed near universal failure. Every last one was changed and any anode load or cathode resistors damaged as a consequence of the leaks were also replaced. Within hours 'first light' of the CRT was achieved and over the next few days an excellent picture was soon produced from what is a tube that looks like new! The photograph shown does not do justice to the image; it is remarkable for a nearly 60 year old monitor.

Time taken: about 20 hours.

Note: This monitor is missing its vented outer casing; I wonder what became of that?

**Conclusions reached**

The above trials were not truly 'scientific', but they have proved to be a useful guide to likely issues and the workload involved. In general, previous findings from restoring a Marconi MkIII camera and various other items from the same series have been confirmed. In summary, these are:

- Replace all Visconol capacitors on sight.
- Replace all selenium HV rectifiers on sight.



- Marconi mains transformers are first class!
- Metal oxide HT rectifiers survive very well.
- Large can electrolytic capacitors will (surprisingly) almost certainly be OK, unless obviously 'distressed'.
- Valves (and CRTs) can be assumed to be OK unless obviously damaged.
- Watch out for previous 'repairs' and 'mods'.

The surprising finding was just how bad the American designed but British made Dubilier capacitors have become in recent years. These were expensive, high quality military grade components in their day, not the horrible 'waxies' found in domestic kit. However, without a doubt:

- See Dubilier capacitor – replace Dubilier capacitor!
- Watch out for damaged anode load resistors and changed value cathode resistors.

Quality axial leaded replacements for the Dubiliers are relatively expensive but the good news is that they are smaller than the originals, which makes them a lot easier to wire in! I wonder if they will last 60 years?

The other surprising finding has been that the 'classical' fault of high value megohm range carbon composition resistors going 'high' has not been found to be prevalent. This could be because where such a component is critical, 'high stab' carbon composition resistors have been used in these units and they have survived really well, as have the electrolytic capacitors. Overall, the picture being painted is of optimism. Knuckle down to changing the Dubiliers, follow a few simple rules and the problems should be manageable, despite the great age of the kit.

**Coming up:**

Before the next CQTV is due, it is hoped that the following will have been achieved:

- Vehicle underside shot blasted.
- Vehicle underside painted.
- Major internal clean-up of the vehicle.
- Internal vehicle mains lighting rewired and operational.
- Full project plan in place, including administration aspects.

So far, so good . . .

**Coming up in CQ-TV 231**

Getting to grips with live video streaming; Capturing, converting and uploading to the Streamer Library; Full report back from the BATC BGM; And more .....

# Thoughts on Microphones

by Mike Cox

When I am not building 3D cameras, or 720P Test Generators, I put a bit of time in as a technician or reader with Richmond Talking Newspaper [RTN], for the blind and hard of seeing. This is recorded once a week, when a team of 4 readers and 2 technicians gather in a local school to put the paper "to bed". Most of the input is from the local newspaper. There is a sound mixer, a pair of cassette recorders, 4 microphones and a bank of Sony high-speed tape duplicators. We need to produce around 120 C90 cassettes by the end of the evening.

One of our problems is that we used tie-clip microphones, and as our readers range in age from 18 to 80+, some are not too clever with their use. In the winter, they get mixed up with scarves, or clatter against jewellery, brooches etc. These microphones also suffer from cable entry problems, giving crackles and noise.

Some time ago, I was given a computer microphone as a "freebie", but could

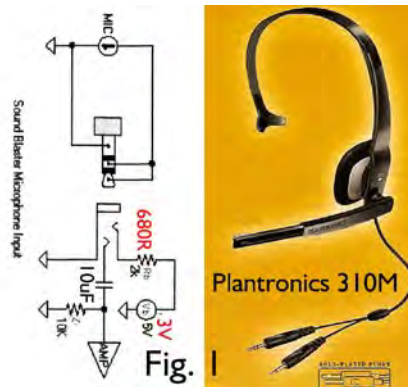

never make it work into an analogue mixer, so it was put aside. I was in Maplin's one day, as one is from time to time, and saw a headset with single earpiece and a boom microphone, which I bought [£9.99]. When I tried it, there was a similar result to the earlier microphone. So I went to Google and put in "Sound Card". There was an article listed that explained all. [www.epanorama.net/links/pc\_sound.html] It also explained why ordinary microphones were so poor into sound card inputs.

The microphone capsules used in computer microphones are electret [Condenser microphones without need for 48 volts polarising], with a buffer amplifier built in. This needs a volt or so to work, and while our tie-clip microphones had LR44 button cells in the case, these capsules take their volts from the computer.

Fig. 1 shows the arrangement, and a Plantronics headset.

Accordingly, a small box was made up with 4 jack sockets, for the microphones, a CR2032 lithium cell [3.0 volts], and appropriate load resistors [680R] and dc blocking capacitors. The output is a cable harness that feeds the sound mixer microphone inputs.

The final microphone choice is Plantronics 310M. 4 of these were purchased through Amazon, and are now in service. Sound clarity is improved compared with the old tie-clip microphones, and if microphones have to be replaced, as has happened with the tie-clip units, they are half the price.

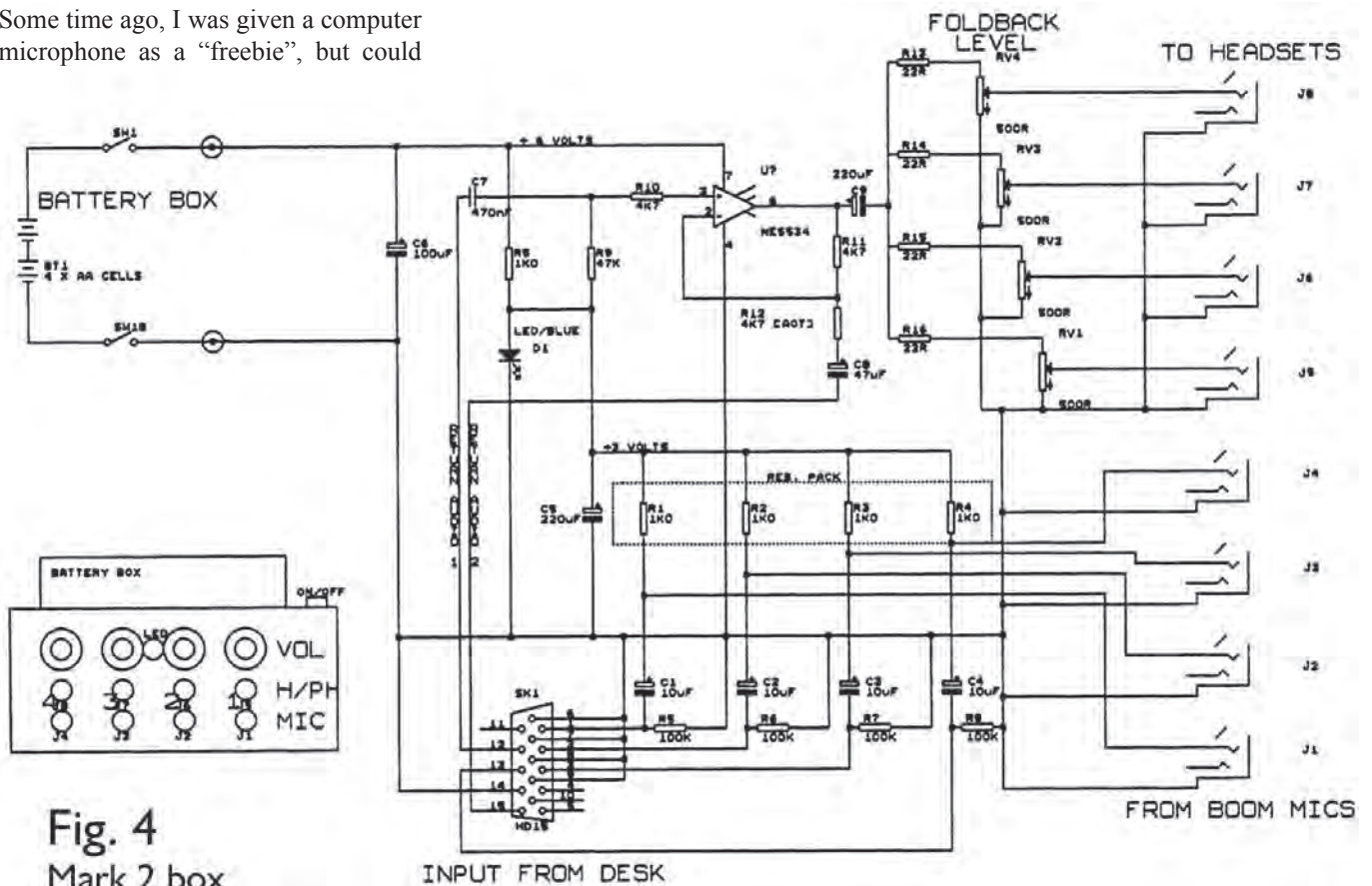

Fig. 4  
Mark 2 box



A next generation box has now been built, with a buffer amplifier for return audio to the earpiece, and individual volume controls for each reader. This version works from 4 AA cells, which should last for a number of editions of the TN.

Fig. 2 shows the Mark 2 box. A VGA cable is used to link to the mixer, as it has 4 coax cores, and a number of other cores. The picture shows tails on one end – I had a few spare cables and chopped one in half. [Fig. 4 shows circuit]



We have successfully used a “computer” microphone in an analogue world. Going the other way is not so good. Unless an expensive sound card is fitted, feeding analogue audio to convert to a digital file is not so good. Laptops can be particularly poor.

One solution is to buy an external sound card. One such we are using to take RTN into the digital world is the Behringer UCA202. [Fig. 3] This device has a USB interface, and is bi-directional, so that it can be used as an output device as well. It takes in high level audio, from a mixer or other audio source, and is widely available at a reasonable price. To record using it, some audio software is needed, such as Audacity or Wavelab Lite.

These will record to .wav files, and a conversion program like Switch will turn it very quickly into a .mp3 file with considerable saving in space.

I may return to this topic when we have progressed further with taking RTN into the digital world, with our content distributed as .mp3 files on USB memory sticks



## Letters to the Editor

**Hello all,**

For anyone who likes to know, and for CQ-TV input please be advised that the Cambridge 23 cm ATV repeater GB3PV has now been equipped with a digital input. This work has been done by Brian G6HFS.

When in beacon mode the repeater alternately transmits a sequence of pictures and test cards for 5 minutes on FM and then 5 minutes Digital, 4165 Ms FEC 7/8 both on 1316 MHz. When accessed the repeater is normally looking for an FM input, but if a QPSK input signal is received, both on 1249 MHz, it will automatically select it. The repeater output mode may be determined by DTMF tones on the input sound channel to be either FM or QPSK.

The following modes are thus possible:  
FM in-FM out. QPSK in-QPSK out.

FM in -QPSK out. QPSK in- FM out. So far both G6HFS and G3KKD have exchanged excellent pictures QPSK-QPSK. The improvement in picture quality due to the absence of any noise on the input signal is very noticeable. It is of course expected that the majority of use will be FM in - QPSK out.

Best 73 to all Ian G3KKD.

### **BATC film Archive**

Is there a kind of Open University broadcasting role here for BATC with webcasts providing good quality theory presentations in support of Full

License courses? In amateur television there is still some scope for home brew construction, and thus for Buildathon projects either with kits or with the methods and approaches in the talk by George G3RJV, and supported by an appropriate webcast on the BATC archive?

Finally, many thanks to BATC on behalf of all the clubs and radio amateurs who have and who will benefit from these and the many other resources across the range of amateur radio interests that are to be found in the BATC archive.

Michael Clarke, Mi5MTC

Email: [mi5mtc@learc.eu](mailto:mi5mtc@learc.eu)

We have now merged the old [cq-tv.com](http://cq-tv.com) website with the clubs primary website: <http://www.batc.org.uk>  
**Please update your bookmarks!**

# Treasurers Report for 2009

The club has made a modest surplus in 2009 and is in a financially strong position. After a number of years of slow reductions in membership, I am pleased to report that numbers are still on the increase. We feel that this is due to the new "cyber" membership rate (£4) and the new streaming facilities at [www.batc.tv](http://www.batc.tv)

## Publications and Members Services

The sale of DVDs to our members produced a surplus of £117. The DVD incorporates much of the written archives of the BATC, including back issues of CQ-TV and the "Television and Lighting" book. Paper back issues of CQ-TV are still available.

Member's services items are also available, badges and test cards etc. along with some of the components for older projects. Enquiries to Chris Smith, details are in CQ-TV.

## [www.batc.tv](http://www.batc.tv)

This service is funded by sponsorship and donations, when you visit the streamer do click on the sponsor's links, their sites are well worth exploring and their support is appreciated. The club has funded some of the peripheral equipment associated with the streaming of events.

## PayPal

The PayPal payment system continues to work well and we have now closed our

old Barclays Merchant Services account. This payment system is available to all, you do not need a PayPal account to use it, and it works with credit/debit cards just fine. If you are in the UK a cheque in the post is very acceptable and avoids the commission charges levied by PayPal. There are a number of other possible payment methods, and if you have problems please contact me, Brian Summers the Hon. Treasurer.

## Investment accounts

The BATC has a number of accounts where our reserves are kept. In the current economic climate the interest paid by these accounts has fallen to a very low level. Our accounts have to be of the "treasurer type" and have never paid much interest, but I have found one offered by the "Teachers Building Society" that does pay a better, but still modest, rate. The BATC has opened an account with them and I shall be transferring more of our funds into it.

Brian Summers Hon. Treasurer  
May 2010

### BATC INCOME & EXPENDITURE ACCOUNT YEAR ENDING DECEMBER 2009

Income account	2007	2008	2009	Expend account	2007	2008	2009
Subscriptions	10,388.26	9,275.83	8,756.13	CQ-TV Printing	4,432.54	4,278.24	4,278.24
Postage, airmail	72.00	66.00	166.50	CQ-TV Postage	1,866.83	1,975.89	1,894.24
Members serv. Surplus	-1,463.74	54.85	-6.75	CQ-TV Production	0.00	170.97	0.00
Publications Surplus	74.65	133.90	117.59	Web & internet	351.47	343.81	0.00
Donations received	1.40	122.00	0.00	Conventions & BGM	0.00	166.50	2,164.34
Interest received	1,147.11	1,372.31	910.50	Committee expenses	0.00	0.00	0.00
Miscellaneous Items	5.00	205.33	202.00	Benefits & Projects	0.00	639.97	224.99
Refunds	0.00	-18.36	0.00	Legal & RSGB aff. fee	44.00	68.99	44.00
				Office expenses	236.81	266.12	207.59
				Bank & Paypal fees	354.24	501.83	416.71
	£10,224.68	£11,211.86	£10,145.97		£7,285.89	£8,412.32	£9,230.11

### BATC BALANCE SHEET AT 31 DECEMBER 2009

Fixed Assets	2007	2008	2009
Equipment purchases	0.00	169.33	200.00
Less depreciation	0.00	-169.33	-200.00
<b>Current Assets</b>			
Stock, members services & publications	422.23	399.54	399.54
Building societies	11,316.14	12,999.13	18,213.62
Bank deposit, HBOS	31,839.34	32,724.04	33,402.54
Current account HBOS	20,404.95	18,867.99	4,947.94
Current account A&L	287.85	613.85	3,542.85
PayPal account		607.67	4,717.45
<b>Less Current liabilities</b>			
Subscriptions received in advance	11,137.90	10,280.07	8,375.93
	£53,132.61	£55,932.15	£56,848.01
<b>Represented by Accumulated fund</b>			
Balance brought forward	50,193.82	53,132.61	55,932.15
Surplus	2,938.79	2,799.54	915.86
Balance carried forward	£53,132.61	£55,932.15	£56,848.01

I have examined the books and records of the British Amateur Television Club and confirm that the balance sheet and the income and expenditure account are in accordance with those books and records.

*Theresa Lees*  
T REES  
DUCKLINGTON  
OXON  
17 April 2010

*B Summers*  
B. SUMMERS HON TREASURER  
CAMBERLEY  
SURREY  
17 April 2010





# Sale of the TV Century?

*A photo report by Dicky Howett of the Bonhams 'Michael Bennett-Levy Early Technology Sale' 30th Sept 2009.*

Trundling down to friendly Bonhams in Knightsbridge (to view but not to buy), the Michael Bennett-Levy sale of tv-related items (and other audio and optical items) proved a fascinating experience. According to the sales brochure (£20) the Bennett-Levy's are decamping to France and so 'everything had to go'. The 'everything' amounted to everything from a '30k volt induction coil' to a Pye Mk3 tv camera channel circa 1956 (incorrectly referred to in the catalogue as an 'orthicon') Never mind, we can't all be experts.

On pre-sale display were many examples of rare (the adjective 'rare' appeared a lot) pre-war television receivers. All pre-war items sold subsequently at the asking and in some cases twice the asking price. The Plessey-built 1930 Baird Televisor listed at £9,000 achieved a 'hammer' price of £18,000 and a similar-design window display model listed at £2,000 made just over £5,000.

In 1934 DIY Daily Express readers could purchase a Televisor kit for



**The Pye Mk3 Camera Channel. Unrealistically priced at £4,000. Repro 'ATV' badging**



**The Block 3 RCA tele- bomber kit**



**The GREEN RAY machine. Margaret has a go.**

£6. The same kit at the Bonhams sale realised a selling price, slightly more expensive at £1,800. Novelty items under the hammer included a Green Ray 'Have Your Mind Read By Television' machine. This fairground attraction from the 1930s pre-supposed that viewers had minds to read. For the insertion of a whole penny the end results were dished out, your tele-fortune printed on cards to keep and savour. The Green

Ray sale asking price was £1,000 but it beamed in at £6,000. Yes, as we have always suspected, there's money to be earned from tv.

Of military interest was the very, very rare 'Block 3' 'aeroplane missile guiding television monitoring system' made by RCA. This iconoscope camera assemblage was installed in B17 bombers at the end of WW2. Two bombers were





**JVC VIDEOSPHERE.  
1966. Sold for £600**

used. One had the camera and was filled with explosives, (the pilot bailed out after take off) and the other B17 acted as the guider. Unfortunately several of the 'guider' craft blew up when the system was switched on (high voltage sparking) killing, on one occasion, Joe Kennedy, elder brother of the President. The sale item Block 3 was obviously never used having a date of 1945. Asking price was £50/70,000 but the hammer came down at £36,000.

Some bidders of other items had clearly lost their heads. A Bush TV22 listed at



**Swedish AGAPHONE wire recorder. A snip at £24**

£300 raised £1,600! Whereas at Bush TV12 listed at £200 made £60. I have it on good authority that an individual bid for and won several Band One aerials. Pristine, 'never used' examples. Chocolate tea pots perhaps but the purchaser acquired roof top telly icons that now are all but vanished from the skyline. A collectable of the future? Who knows? Time to ask the Green Ray.....

PS. The Pye Mk 3 camera channel failed to sell at an asking price of £4,000.

Note: All prices quoted are the 'hammer' price and do not include VAT or any other commissions attached.

Dicky Howett  
October 2009



**A Plessey-built Baird Televisor.  
Sold for £18,000**



**Baird mirror lid with radio, record player and drinks cabinet. TV in the 1930s had the rich in mind. Same today. Sale hammer price £18,000**



# Towards the third dimension

by Mike Cox

Since the last piece about this in CQ TV 228, a bit of progress has been made. For our experimental camera, a convergence angle tweak has been added, together with a small adjustment of right camera height relative to the other. [Fig. 1, 2] The two Sony cameras used are set at widest lens angle, as it not yet proposed to attempt any zooming, for reasons that are discussed later.

The CCU has now been put in a more convenient case, with adjustment through the front for the two synchronisers. Two clean outputs of left and right video have been fitted, as well as two outputs of field sequential video. Also, a test generator has been built in to assist in projector alignment. When the panel switch is operated, the active video from the cameras is replaced by a grating, for convergence adjustment, and a 4 step grey scale for white balance adjustment. [Fig.3 CCU]

## Display

The problems with shuttered glasses were set out in the last piece, and so 2 Acer X110 DLP projectors have been acquired and fitted into a "cage". The top and bottom plates of the cage were identical in size and pierced to allow for a 1/4" bolt to anchor each projector to its tripod bush. The side plates are pivoted at the front so that the top plate can tilt. Tilt is adjusted by means of 6mm threaded rod which moves the back of the plate up or down against tension in elastic bands. Wing nuts provide for movement and locking.

Trapezium adjustment of this projector, together with the zoom control and tilt allow the images to be converged. I managed to borrow 3 pairs of Dolby glasses, which use the wavelength multiplex system [www.infitec.com], also mentioned in CQ TV 228. Using some strategically placed rubber bands, I was able to mount the left eyepiece of one pair in front of the lens of the left projector, and the right eyepiece in front of the other projector. When the

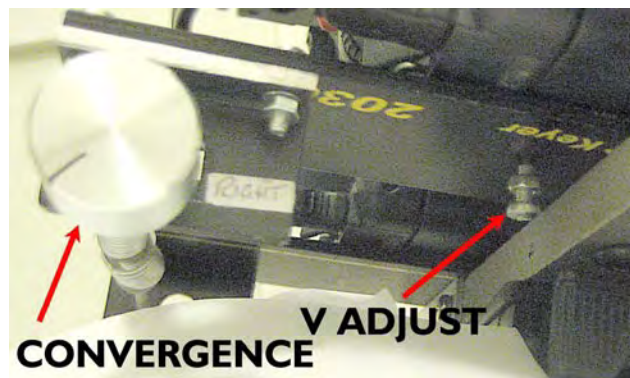
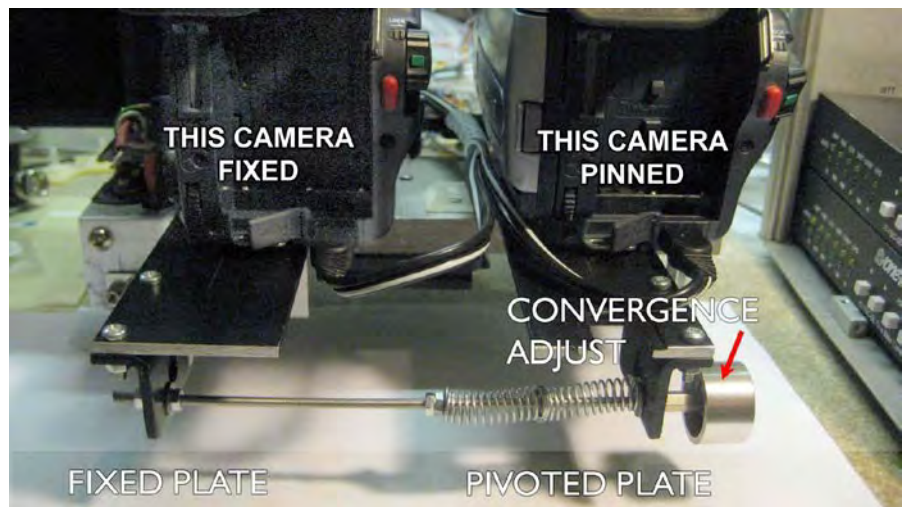
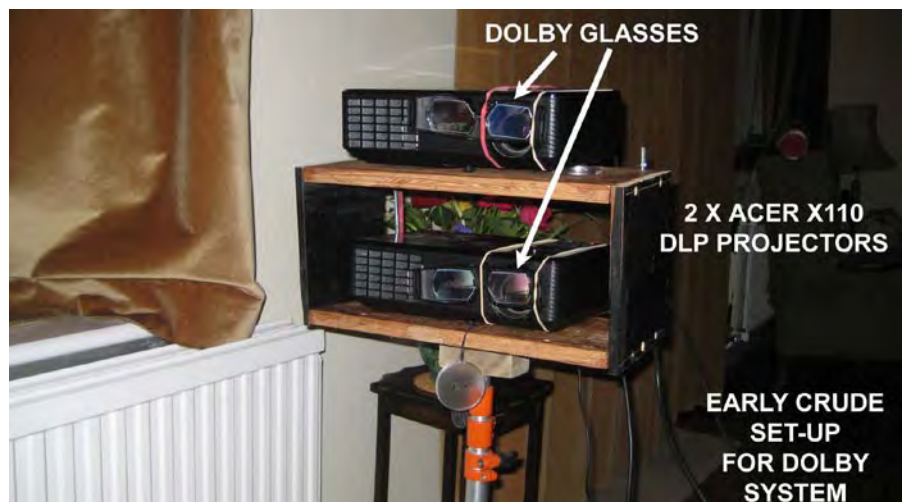

Figure 1, above

Figure 2, left

Figure 3, below

Figure 4, bottom





camera was connected to the projectors and the projectors aligned on the wall, a reasonable stereoscopic image could be seen. [Fig. 4 projector set-up]

However there is considerable light loss with these glasses, despite the obvious advantage of being able to use the wall as a projection screen. The realD system using circular polarising filters seems to have more going for it. One drawback to this is that a silver screen is needed to avoid upsetting the polarisation.

I was fortunate in being able to source a damaged 12' x 9' silver screen and cut a 4 foot wide section from it. This has been mounted on a sheet of MDF.

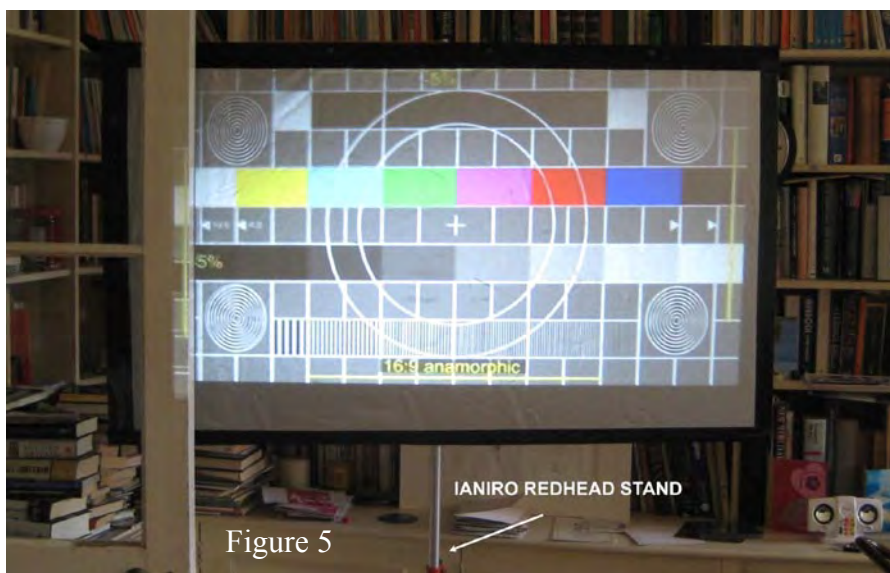

Figure 5



Figure 6

The dimensions were such that the screen has an aspect ratio of 16:9. One of the problems with both the projector cage and the screen is how to support them from the floor. In my capacious garage I found 2 Ianiro Redhead stands. The projector cage has a wood block underneath, which is bored to take the boss of the lighting stand, and similarly the batten at the top rear of the screen is bored to take the boss of the other stand.

On trial, the two projectors were aligned to the screen using a RJR test pattern generator, and circular polarising filters cut from a pair of realD glasses were then fixed to the filter holders in front of each projector lens. [Fig. 5, Screen View]

Care has to be taken that light passes through the filters the right way and a little experiment is necessary to check this. [Fig. 6, Projector View]

Once the system seemed to be working, the camera head was connected and again a reasonable stereoscopic image could be seen. As we have several pairs

of real D glasses available, my wife and I were able to see a 3-D image of the garden on a 4 foot screen. The thrill was almost comparable to getting my colour camera working back in 1966! [CQ-TV60]

RealD glasses seem to be widely and cheaply available on eBay and similar sources. The success of films such as "Avatar" has put many thousands of pairs of glasses into the public domain. [Fig. 7, realD glasses]

### Progress in 3D TV

There has been an enormous revival of interest in 3D TV, particularly at the recent NAB show in Las Vegas. Many manufacturers are showing kit, Panasonic a one box 3D camera [Fig. 8 AG-3AD1] for around \$20,000,



Figure 7

recording on P2 cards. Miranda, JVC and Sony were showing 3D video processors, the JVC one claiming to be able to convert 2D material into 3D. Samsung yesterday [28/4/10] announced a 3D LCD TV to the UK market. A Panasonic 50" 3D plasma is on sale for \$2500 in the USA.

What is not being clearly stated is how the 3D images are coded for transmission, or what type of glasses is needed for viewing. There are a number of possibilities; there is field/frame sequential, side by side, or alternate line. All these rely on the type of re-scaling/re-sampling technology that is built in to modern displays. Side by side appears to be the current thinking behind the ESPN and Sky transmissions. It works as follows:

The left and right eye images are shrunk horizontally by a factor of 2 so that viewed on a picture monitor, left view would be left half of screen and right view right half of screen.

Half the horizontal resolution is lost by this technique. At the receiver,



expanders are used to give two sets of pixels for left and right. These can be displayed sequentially viewed with active shuttered glasses, or on two projectors, using polarising filters. [Fig.9 Side by Side system] Some of you may remember a similar time compression technique being used in the Sony Betacam VTR, and also in the D/D2MAC satellite system used by BSB, and one or two others.

SMPTE has a Working Party looking at standards for 3D TV, and great things are hoped from it, lest we end up with a VHS/Betamax type clash or Blue Ray versus HD-DVD more recently. It is due to report towards the end of 2010.

Sky has started a regular sports service, initially to pubs, using LG displays, while ESPN is proposing 3D coverage of the football World Cup from South Africa this summer.

Just to add to the confusion, Toshiba is about to launch a 21" LCD 3D display that is "autostereoscopic", i.e. you don't need glasses to see the 3D image. From the small amount of information, it appears to be a very high resolution LCD using sets of fine cylindrical lenses to take views from up to 8 points at each pixel. Thus movement of the viewer's head will not cause loss of 3D effect, unlike the Philips WOWx system of a few years back, where you had to keep your head still or you lose the effect.

### Image Capture

However, there are some interesting problems in capturing the 3D image. Camera rigs provide various adjustments such as inter-ocular distance, and convergence angle. [Fig. 10, Camera details] Some camera rigs have one camera mounted conventionally, and the other at 90 degrees to it, with a front silvered mirror to correct the optical path. This allows greater flexibility in inter-ocular distance adjustment, not possible with "chunky" cameras on parallel rigs.

It is essential that the mount is rigid, and able to maintain adjustments once set. But our problems don't end there. If we are using fixed lens "film" type cameras such as the Red or Arri type, then we don't have to worry about zoom

### Panasonic Camcorder Packs Two Lenses for Full HD in 3D



Figure 8

Figure 9

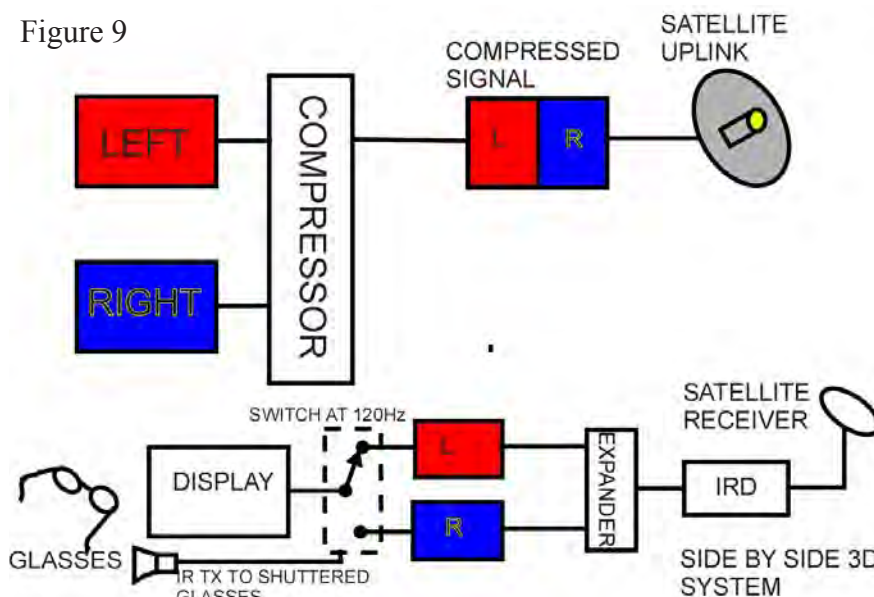

tracking. We still have to worry about 2 sets of camera electronics keeping in alignment though.

Lens makers such as Fujinon are now offering 3D lenses with precise control of zoom, focus and aperture so that they track throughout their range.

### Where to go now

It is all very well having a closed circuit 3D system, but a way of recording the result is essential. I mentioned in one of the earlier pieces that a successful recording of the field sequential signal had been made and played back using shuttered glasses and a small CRT monitor. Now I have the dual projector display system working, it would set the cap on it to be able to record things various and play them back. So the next part of the project is to do just that. A simple way to start with is to take the playback FS signal, and apply it to a set

of switches that are set to take alternate fields to black [and sync]. Field 1 goes to the left projector, and field 2 to the right projector. [Fig. 11. Field Inhibit]

Thus the polarisers come into play, and many or few can watch. The processing in the projector seems to fill in the missing field with something so the sensation of flicker is reduced. Trust me, I have tried it.

A more sophisticated way for later on is to write the fields into a store and read them out twice. Vertical resolution will be lost, but that is to be expected. Quarts into pint pots may come to mind.

That is as far as I have got for now. I hope to have something to demonstrate at the BGM. Hope to see some of you there.

Mike Cox  
Twickenham  
May 2010

# Display Units from The BlackBoxCamera Company Ltd

by Brian Kelly GW6BWX

Few readers can have missed the adverts for on-screen display units from The BlackBoxCamera Company in CQ-TV. Looking through back issues, they have been gracing our pages for over 10 years and in recent times they have donated the prizes for our caption competitions. As winner of the competition a few issues ago, I was very happy to receive one of their "Video Text Overlay Unit" boxes in the post and here I'm going to review its operation. I confess I already had one of their units which worked flawlessly for several years but after being left unused for some time and quite likely getting some physical and electrical abuse, refused to run again when brought out of retirement. I had intended to review this unit together with their newer products so I contacted The BlackBoxCamera Company for technical advice on repairing it. To my surprise, they not only sent me information on how to repair it but told me the design had been superseded and kindly provided a sample of their new design of board for this review. Full marks to them for being so cooperative and generous, I not only have the new units but the old one is back in service again.

BlackBoxCamera Company's original units used an IC from ST Microelectronics called STV5730A which is intended for use in domestic equipment where it would insert text and pre-defined characters into the picture. The characters are optimised for satellite and VCR applications and include such things as symbols for rewind and fast forward as well as numbers and international alphabets. Whilst still very useful, the limited font can be a limitation when used for other purposes. Unfortunately, ST stopped making this IC some time ago so BlackBoxCamera Company's new designs have moved to using a newer and more versatile device, the Maxim MAX7456. Functionally the two devices are similar, even the character fonts are almost the same but the MAX7456 has 256 characters while the STV5730A

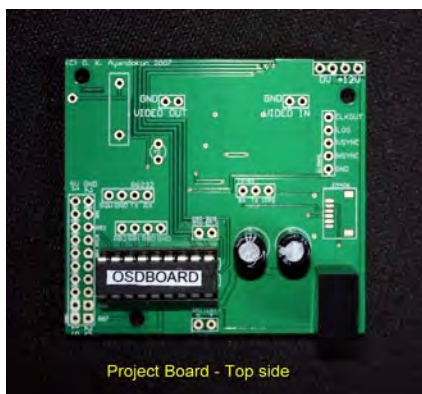

only has 128. From a users point of view, the biggest difference is that while the old device has the font permanently built into silicon, the new one holds its font in EEPROM. This means that the character shapes can be redefined and will be retained even after the power is removed. The font is 12 pixels wide and 18 pixels high with no borders between character positions so it is possible to make shapes which span more than one character cell without gaps appearing. To make life easy, Maxim pre-load numbers, lower case and upper case characters and a few symbols into the memory before it leaves the factory so it can be used straight away.

The BlackBoxCamera Company have very cleverly designed a multi-purpose circuit board which can be adapted to perform many functions. Provision is made for several different interfaces and peripheral connections with only the parts applicable for the version being purchased being fitted.

The least populated version is the "Project Board" which is basically a PIC microprocessor, the MAX7456, a power regulator and some video interfacing circuits. With the exception of the microprocessor, two electrolytic capacitors and supply regulator, all components are surface mounted. The processor is fitted in a socket for easy removal in case it has to be taken out for reprogramming although I successfully programmed the one on my old board while it was still in-situ. I cannot see any reason why the same can't be done on the new board as well. The microprocessors reset pin and all the port pins other than ones dedicated to on-board interfacing are taken to solder pads for easy connection to other circuits. The board dimensions are 60 x 54mm and distance across the highest components is 15mm. Three mounting holes are provided.

The boxed version being offered as the competition prize is the same PCB but fitted with some of the optional parts (I peeked inside the box!) which include a clock/calendar IC, a quartz crystal to keep the clock accurate and a back-up battery to keep it running when the power is disconnected. As well as being able to superimpose text and graphics, it

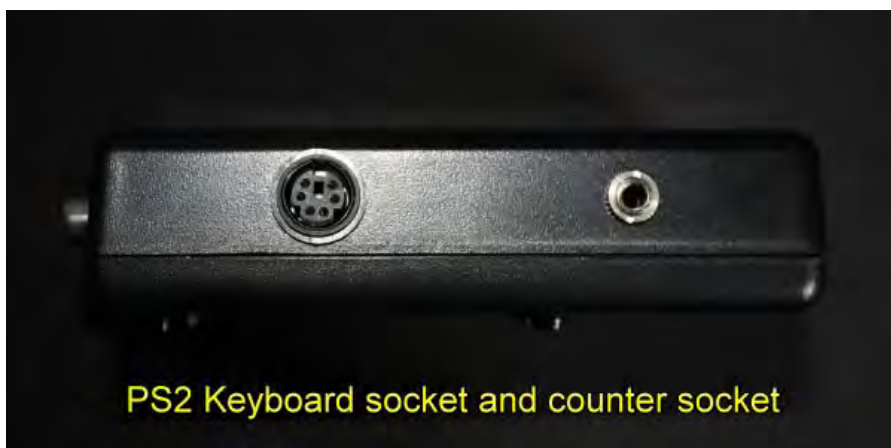





Power, video in and out sockets

has a PS2 style (standard PC) keyboard socket and an input for pulse counting. No prizes for working out what the keyboard does, it puts text into the picture! It also has a three pole 3.5mm jack socket which is intended to be used as a bi-directional pulse counter input. This isn't as complicated as it sounds, one input bumps the count and the other is sampled to see if the count is up or down. The inputs can be used purely as a way of counting a total or if connected to a rotary encoder it can count up or down depending on the direction of rotation. It could for example be used for measuring distance based upon the amount the encoder was turned. Provision is made in the units software to apply a scaling factor to make the units more manageable. Scaling, clock setting, cursor positioning, character attributes (flashing, reverse video and brightness) are controlled by using the keyboard 'F' keys, in some cases in conjunction with the ALT, CTR and shift keys. The box itself is nicely presented in black ABS and fitted with four non-slip feet. I measured the dimensions as 118 x 67 x 30mm including sockets and feet. It has a battery cover but this is permanently fixed in the closed position as the unit can only be powered from outside. All the external connectors are of good quality and a 3.5mm jack plug is provided for connecting to the counter input. Curiously, the white label on the top of the box does not annotate the keyboard socket or counter socket but their purpose is well documented in the instruction sheets.

Other variants of the units are available for more specific applications, for example a version is available with built in GPS. A CD is available which details the different units and give many examples of program code to use these features. The examples include displays of MSF time signals, use as a cash register display and how to

display results from a weather station. It also includes the the data sheets for the microprocessor and MAX7456 for anyone wanting to customise their own software and a font editing utility to simplify the creation of new character shapes. It would be relatively easy to adapt a unit to superimpose information on a repeater output for ATV use or program information for broadcast use.

### Technical tests

Both the boxed and project board units were tested and as expected the video results were indistinguishable, no doubt because the signal processing circuits were identical. The HF response was excellent and there was absolutely no signs of tilting during the vertical blanking period or when a screen full of all white characters was displayed. The brightness of the characters is adjustable from the keyboard or by using the 'ZA' command through the serial interface on the project board. The default level was slightly higher than normal peak white at 1.05V above sync tips but caused no problems on the two monitors I used to test them. Reducing the level by one step brought the level slightly below peak white.

Current consumption was 54mA from a 9V supply, dropping to 44mA at 12V, adding the keyboard increased this by 5mA but of course this increase is largely dependant on the keyboard being used. The drop in current as the voltage was increased is due to the on-board switch mode regulator. These measurements were taken with 75% colour bars displayed and with the clock and counters enabled and displayed. Although the documentation clearly warns about using a suitable power supply, it would appear that the power inputs have reverse polarity protection. I reduced the supply to find the failure point and there was no degradation of output until the device stopped completely at 5.9V. The maximum voltage is specified as 12V but the specification for the regulator suggests it will accept more. While I do not advise anyone to exceed the documented voltage, it gives me confidence that it will withstand unstable supplies

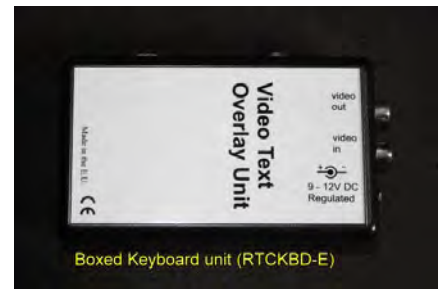

Boxed Keyboard unit (RTCKBD-E)

such as in a car where the battery may momentarily go over-voltage.

With the input shorted there was no visible noise produced from internal circuitry although an oscilloscope revealed a tiny vestige (< 2mV) of sine wave at around 54MHz, probably the second harmonic of the MAX7456 clock oscillator, and a pulsing signal at around 135KHz which is probably from internal control signals. These levels are very low and should not cause problems in normal use. The circuit board layout is very well designed and video carrying traces and power traces are kept well apart. The proper rules for signal grounding are also respected and no doubt this contributes to the overall cleanliness of the output.

In the absence of an input signal, or under command from the keyboard, the unit switches to internal sync generation so it can be used 'stand alone' without an input signal to lock on to.

The Project board has some useful signals available on connection pads, these are a 27MHz crystal controlled clock signal, a signal indicating whether input syncs are present and both horizontal and vertical sync pulses. These come directly from the Maxim IC so users are referred to the data sheet for detailed descriptions.

### Value for money?

Very definitely yes, these are very useful devices and when assessing the cost it should be borne in mind that the MAX7456 alone costs £28 (Farnell, May 2010) so with the remaining components, a PCB and box it would be difficult to match BlackBoxCamera Company's prices if made at home. I give them a definite thumbs up !

# HDTV in the USA

by Dave Crump G8GKQ

In this article I will describe how the technical quality of TV delivered to homes in the USA has overtaken what is available in the UK, and also how high speed internet is provided through the same system.

## Consumer Choice

On arrival in the USA, I found that there were 3 options available for terrestrial TV, Internet and phone services:

a. Broadcast TV, with dial-up internet and twisted pair telephone. A limited number of Standard Definition (SD) channels were available as analogue free-to-air broadcasts, and there was already an overhead phone line wired to my house. Since my arrival, all free-to-air broadcasts have been converted to digital, using the ATSC standard.

b. Cable TV, with Cable internet and twisted pair telephone. This option provided multiple SD and High Definition (HD) TV Channels, and used the same coax cable to provide a broadband internet connection. Telephone services would be provided through an overhead phone line.

c. Fibre-optic TV, Internet and Telephone. This option offered multiple SD and HD TV Channels with broadband internet and telephone all delivered through a single fibre.

There were also 2 satellite-delivered TV services available (DirecTV and Dish TV) but these offered limited TV Channels at a higher price intended for use in rural areas not served by Cable companies.

## Installation

I ordered the Fibre-optic service (marketed as FIOS by Verizon Communications), and was informed that installation would take 2 weeks. First of all, a contractor came to my property to mark the path of all underground utilities near the proposed

fibre installation. Then a second contractor came to install a fibre cable from the overhead utility pole at the roadside, under my front garden, to the side of the house. Finally on installation day the Verizon installer arrived at the appointed time and started work. His first task was to install an externally-mounted Optical Network Terminal (ONT) on the outside of the house. He then terminated and connected the fibre to the utility pole distribution unit and the ONT.

## Internal Wiring

The installation is designed to use the existing internal TV and telephone wiring in the house, and uses the TV RF coax to relay the internet traffic using a technology called MoCA (Multimedia over Coax Alliance). So, the installer simply connected the existing TV Coax and twisted pair telephone line to the ONT. Additionally, a wire from a mains powered low voltage power supply was routed from inside the house to the ONT. The completed installation is shown below.

I was impressed that the installer checked the RF signal level at each TV outlet, and replaced some old splitters to bring everything up to the correct levels.

## Telephone Service

Clearly, provision of telephone service is dependent on power for the fibre modem. The ONT power supply incorporates a rechargeable battery which gives 6 hours standby time after a power cut. After this time limit, you can press a button on the power supply to make an emergency outward call using the remaining power.

The telephone service is very good quality and provides Caller ID – not only the number, but also the caller's name or Company as well.

## Internet Service

The internet service is provided through a modem with wireless router that connects to the TV Coax. When I first signed up, the service was 5 Mbps down, 2 Mbps up. I now have 20 Mbps down and 5 Mbps up. The current top-end domestic offering is 50 Mbps down and 20 Mbps up, although this comes at a higher price! Having experienced high contention ratios on ADSL in the UK, I have been really impressed that I normally achieve at least 75% of these advertised rates. There is no monthly download limit. Recent newspaper reports that I have seen say that 68%

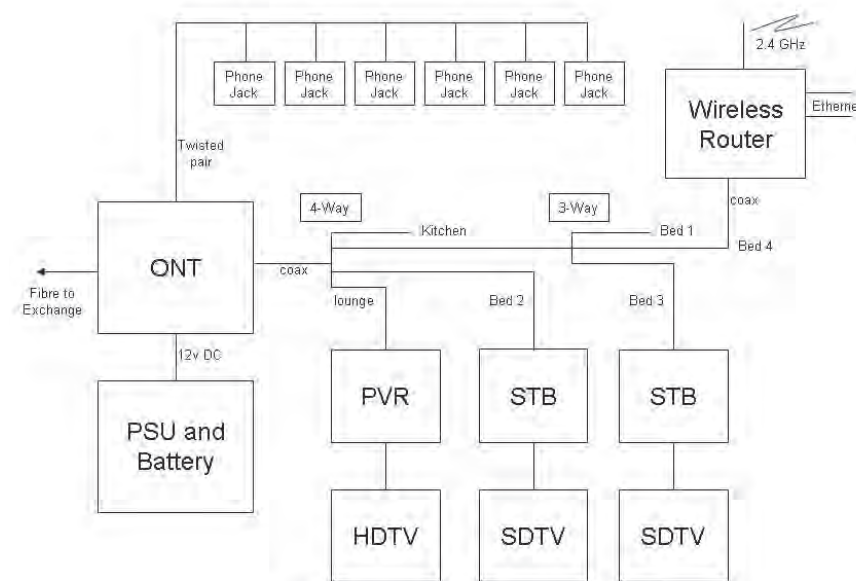

Installation Details



of US Households have internet and at least 63% have broadband.

My connection is dynamic IP (although it has only changed 5 times in 2 years) and the only blocked port is port 80 inbound. This means that subscribers cannot run their own web servers unless they use the https protocol (which I do).

As the internet traffic uses the TV wiring, the wireless router can be placed in any room with a TV outlet and this saves Verizon potential installation costs.

### TV Service

The TV Service uses encrypted QAM in the 42–860 MHz range and provides 387 channels including 100 simultaneous HD channels. Video on demand is also provided – this uses IPTV, rather than one of the “RF” channels.

### HDTV Quality

I have followed the recent debate on HDTV quality in the UK, and assessed the picture quality delivered to my 720p HDTV. Some of the programming is absolutely stunning in its quality, but some less so. I assume that Verizon allocate sufficient bandwidth where it is merited. Unfortunately, shows such as Top Gear are only shown in SD on BBC America, so a direct comparison is not possible.

### Programme Choice

US programming has often been derided in the UK. All I can say is that, after travelling to the US regularly over the last 25 years, the programming is getting better!

### Optical Technology

There are 3 different optical wavelengths used in the fibre. One carries the RF Video signal to the consumer, another

carries the internet and video on demand to the consumer, and the third provides the internet uplink and Video on Demand control signals. The diagram below shows this.

A good summary of the features of the Optical Network Terminal can be found in the datasheet referenced at the end of the article.

### MoCA

I was intrigued by the use of MoCA. This very robust protocol uses the 850 – 1500 MHz range to carry Ethernet traffic at up to 175 Mbps. It traverses splitters using crosstalk, and coexists happily with normal TV signal.

### Conclusion

I am not aware of any similarly-capable domestic service in the UK, and will miss the service when I leave the US later this year. I hope that this article has sparked your curiosity and you’ll check out some of the references below.

### References:

Verizon FIOS Channel Line up:  
<http://www22.verizon.com/Residential/FiOSTV/ChannelLineup/ChannelLineup.htm?zipCode=23451>

Multimedia over Coax Alliance (MoCA): <http://www.mocalliance.org/>

Actiontec MoCA Router:  
<http://www.actiontec.com/products/datasheets/MI424WR%20Fiber%20Router%20Datasheetv2-1.pdf>

Optical Network Terminal Datasheet:  
[http://www.mocalliance.org/industry/white\\_papers/06331r00MCA\\_Members-Tellabs\\_Member\\_Company\\_White\\_Paper.pdf](http://www.mocalliance.org/industry/white_papers/06331r00MCA_Members-Tellabs_Member_Company_White_Paper.pdf)

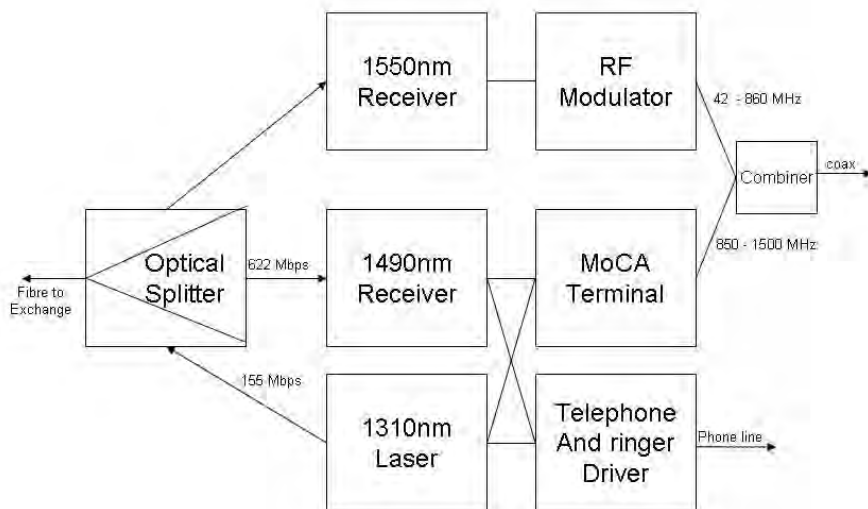

**Optical Network Terminal**

See you all at the BGM  
Hellidon Lakes Hotel on the evening of Saturday 5th June  
and all day on Sunday 6th June 2010  
See the Chairmans Column for details

# Melbourne DATV Repeater - VK3RTV

By Peter Cossins VK3BFG

The initial licence for the Melbourne Amateur Television Repeater VK3RTV was issued by the Postal and Telecommunications Department on September 5th, 1978 and the 'Mark 2' version of the repeater was turned on at Olinda on Mount Dandenong on 4th May 1979.

A number of changes have occurred over the years including Black and White to Colour, moving the output from 50 cms down to 70 cms, replacement of antenna, a new controller, an on site DVD player and changing/adding the input frequencies of 1250 and 1283 Mhz and 10.41 Ghz.

ATV activity in the eighties and early nineties was very high in Melbourne with more than 40 stations active. Over recent times, activity had been reduced to a few enthusiasts.

I had been following developments in DATV (Digital Amateur Television) in Europe and thought that a change to digital would provide an impetus for increases in activity. It was also in the spirit of amateur radio to experiment with emerging technologies.

SR Systems in Germany run by Stefan Riemann DG6FAC, had PCB's available 'at a reduced price' for amateur operators that could be assembled to form the basis of a digital television system. Stefan has been a leader in this area and you can find references to his work dating back 10 years or so.

Reading around the DATV literature available, I found that amateurs had favoured DVB-S. This is the satellite standard and can be sustained in smaller bandwidths than analogue TV. It is also more robust from a communications point of view. A satellite receiver specifically connected to an appropriate antenna was required to receive this mode. A receive down converter would be required if we used the current 70 cms allocation.



Mount Dandenong is a good RF location with a null only in one direction. ATV signals can be received 30 – 40 kilometres away and further.

I decided that DVB-T would be the way to go as this can be received on normal set top boxes (with manual tuning) that many people may already have. These were dirt cheap now anyway and the purchase of a set top box also can serve as a receiver for commercial television.

What we would need is an MPEG Encoder and DVB-T Modulator and to build some linear amplifiers. On further investigation and dialogue with Stefan, I found out that we could fit two 5.5 Mbit television digital channels into the current 7 Mhz 70 cms ATV allocation. This would require an additional MUX PCB and another MPEG Encoder.

Now to calculate the burning question .... how much would this cost and also what other equipment would be needed to be assembled and/or built. On estimations and quotations, it was found that this would require a significant amount of funds, well out of the range of passing a hat around for donations amongst Melbourne ATV operators.

I decided to write a submission to Amateur Radio Victoria in an attempt to gain financial support. The response from AR Victoria was positive, but they indicated that a number of projects in

progress had priority and needed to be completed, but support was indicated for the proposals for some time in the future.

In late 2008, AR Victoria saw its way clear to fund the project. At the same time, innovative projects were being sought by the Wireless Institute of Australia and a submission was duly written. The result was again positive and we now had sufficient funds to proceed.

As we had to simultaneously control two channels a new controller needed to be built.



3 Element Yagi Antennas



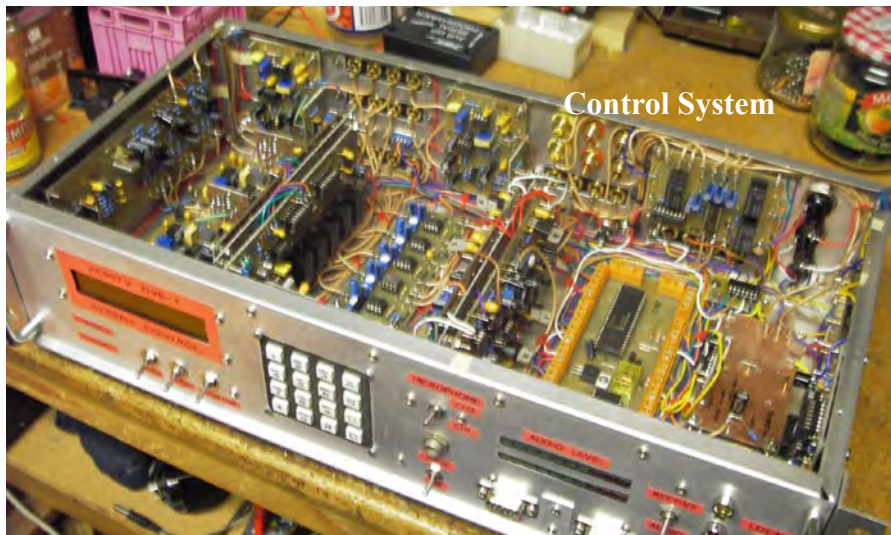

Naming the channels, VK3RTV1 and VK3RTV2, a decision had to be made regarding management of the two channel sound that was available. Already many functions had doubled, but adding stereo sound would mean the sound mixing system would be quadrupled. Discussions around ATV operators resulted in a consensus that stereo sound was not required and that we could use one channel for sound associated with video and one channel for administrative control or perhaps patching the 2 metre liaison frequency.

I also wanted the control system to be in one rack mounted box; this turned out to be quite a challenge to fit everything in and also retain a level of serviceability. The video and sound mixing boards were mounted back to back vertically and then the system grew like topsy in a sort of planned way, but some of the existing boards could be integrated and there is a bit of functional duplication in the final unit.

I used relays for switching the video .... yes I could have used electronic switches but I had a large supply of DPDT 12V relays and a scarce supply of electronic switches which are sometimes difficult to source. This type of switching had been used for the last 30 years in VK3RTV with a high degree of reliability so a 'no cost' electromechanical solution was adopted. The final video line driver is slightly compensated to counteract the lack of bandwidth of the output video from the satellite receiver. One of the outputs from each the line driver is connected to a local video monitor and there is also a local audio monitor, switched by the same hardware.

The audio system uses CMOS electronic switching and Op Amp mixing and includes a local microphone amplifier, a bandpass filter to convert ID and tone square waves from the microcontrollers to sinusoidal, a drive to VU meters and an output amplifier.

Two Picaxe 40X microprocessors were used as the software is delightfully easy to use and they have flash ROM that can be burned via a RS232 port. Dual DTMF encoders and decoders were installed, the encoders to allow local touch tone control. Each video input has a VDA (Video Distribution Amplifier), one port of which goes to the sync detectors for analogue and in the case of the internal colour bar generator and external DVD player, to VK3RTV1 and also VK3RTV2.

Instead of using LED indicators, system status information is provided by a LCD display on the front panel. Other switching includes local monitor and local microphone and also darlington output drives for switching external relays for future higher power linears.



Apart from the video and audio outputs for VK3RTV1 and VK3RTV2, there are two further outputs for extensions of facility in the future.

The modulator can be switched on and off via a RS232 port, but runs only at 115.2 K Baud. As this is not possible from a Picaxe, an additional Atmel AVR microprocessor was added. This is controlled by the Picaxe's, and sends the required codes to the modulator at 115.2 K Baud. It also provides the drives for the darlington output circuits.

The philosophy of the inputs was to have one analogue and one digital (DVB-S) for each output channel. VK3RTV1 has 1250 Analogue and VK3RTV2 has 10.41 Ghz Analogue. At the time of writing, VK3RTV2 has 1276 DVB-S and VK3RTV1 has yet to get its digital input.

The MPEG encoders, multiplexer and modulator were all installed in a rack mounted case including a small linear amplifier to raise the power level enough to drive a FET module PA. The power supply is over voltage protected and the linear amplifier relay switched by the controller.

Robert Broomhead, VK3DN came up with an excellent 12V 46A power supply all in a case including fans that produce a copious flow of air over the system. An added bonus was that they have remote control function which can be facilitated by the system microprocessor.

A RA60H4047M1 60 Watt FET Module was purchased from RF Parts in California and mounted in an enclosed heatsink and fan assembly. Digital television requires extremely linear RF



amplifiers and hence it was necessary to bias the module close to Class A. This is an extremely inefficient mode with a maximum efficiency of 50%. The actual efficiency obtained for digital television was about 14 % !!!.

I decided that this amplifier would be power supply switched using the nice big units provided by Robert Broomhead. This gives the PA time to cool down when the repeater is not in use. The output power at the moment is about 10 watts and good signal reports have been received from all over Melbourne.

The pictures below show how the bandwidth rapidly increases with increase of drive.

This effect is extremely non-linear and the growth occurs at an alarmingly fast rate after a certain point has been reached. Similar effects can be seen

with overdriven SSB, but with DATV this occurs very much earlier. The result is that the PA's have to be run in Class A and also driven lightly. This produces a highly inefficient RF system. As the bandwidth of the system is 7 Mhz and the centre frequency is 446.5 Mhz, care must be taken to ensure that the spectrum is clean enough and does not infringe with significant out of band signals.

I have a 28V 100 Watt amplifier donated (loaned) to me to try out. It will be interesting to see how it works. I am sure a fan will be required when the bias is moved towards Class A.

With an analogue input to the system, the results are extremely good with an improved output S/N compared to the previous versions.

With a DVB-S input it is even better with

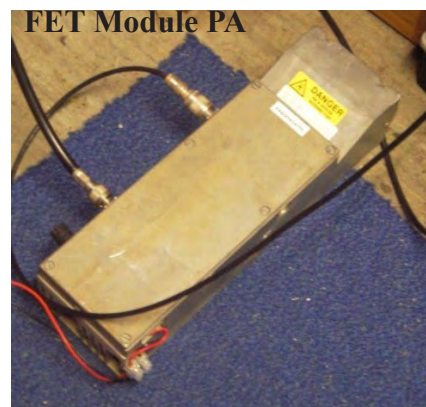

virtually no added noise. The quality of the transmission is fairly close to the quality of the originating video !!!

Thanks to AR Victoria, the Wireless Institute of Australia, and also the members of the Melbourne ATV community whose donations of money and equipment over the years have kept VK3RTV on air.

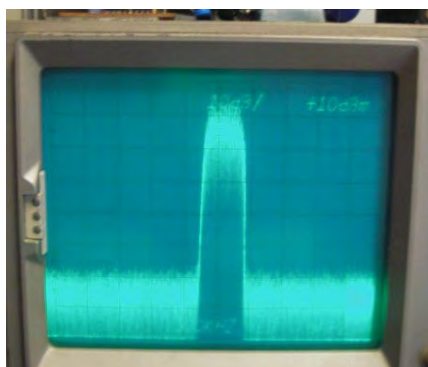

Good

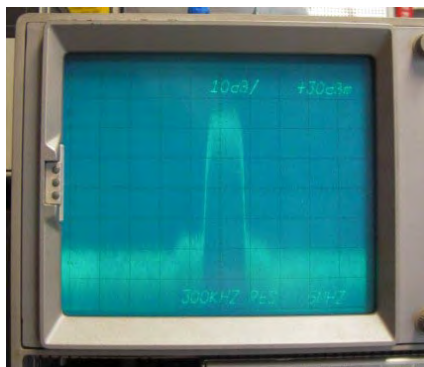

Still OK

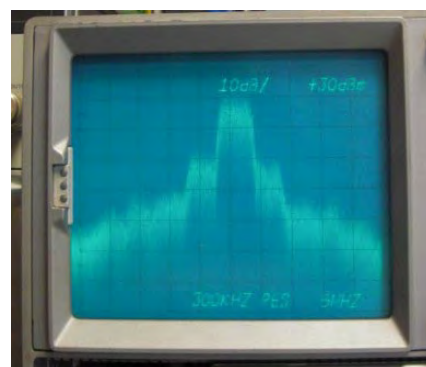

Poor



Phil Gardner, VK3GMZ deserves a special mention for all his work in support. Thanks also to Richard Carden VK4XLR, for his advice behind the scenes during the project. (Richard has been running DVB-T and DVB-S in Queensland for some time.)

With the excellent quality now available it is hoped that ATV Operators will continue to develop appropriate programs of interest for transmission. Lower level licensees may be encouraged to upgrade and experiment in this fascinating component of our hobby.



# AGAF TV-AMATEUR 156

English translation by Klaus, DL4KCK

Is amateur radio still primary on 70 cm? More and more we are observing a trend here in Germany that the authority BNetzA keeps increasing restrictions (like TX ban or repeater licence withdrawal) on 70 cm ATV. The stated reason for this: ISM applications have to be protected! But even on their own website we can still read about ISM applications on 433 MHz: and that no protection from interference is possible.

It is shoddy that simple radio-keys for some private cars are centred on, 70cms, these older radio-keys are not "state of the art" any more and do not correspond to up to date regulations on private property protection. There were TV documentations on this topic, i.e. "3Sat" on 21.9.2009: "Interfering transmitters are able to prevent car doors from locking, as some radio-keys are sharing the same frequency range with radio-thermometers, garage doors, baby-phones and remote controls. Car drivers should always check that the car doors are indeed closed.

German associations of car owners have stated, that secure locking is not possible with such "simple radio-keys"

1. Using these devices is a breach of legal regulations;
2. Insurance agencies paying for stolen valuables out of cars equipped with such simple radio-keys are acting against the law, insurability presumes a safely locked object.

It would be wise to indicate to the owner of such a "simple radio-key" the car manufacturer's responsibility for an update (by car-recall?) and to the insurance agencies to abandon any payment in such a case. Shouldn't we confront the public with the shakiness of these devices via print media, radio and television programs?

73 Heinz, DC6MR

## Electronic fuse for mast preamps

Older satellite TV receivers have only fuse wire protection for their LNC power supply, and the receiver case has to be opened for exchange. The following little circuit will prevent that, if it is fitted into the line. Another option is to short circuit proof, simple power supplies, but note: the BD140 will only stand up to 1.5 A maximum!

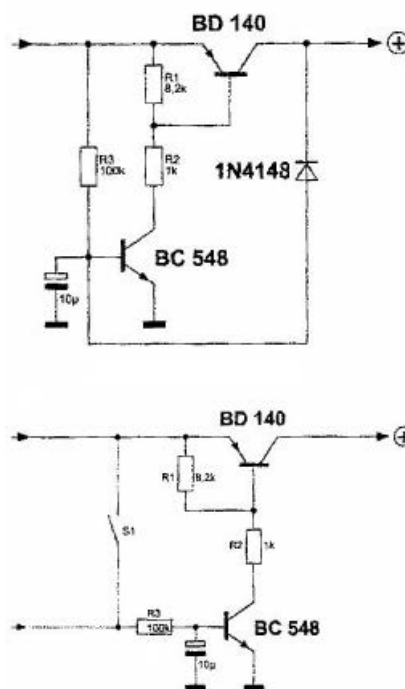

T2 is getting the bias over R3 and will open T1. If a short is shutting down the output, D1 will pull down the bias for T2 and T1 is blocked, until the output short is rescinded. For a higher durable current than 1 amp the BD140 has to be exchanged, also R1 and R2. Another usage would be possible as relay replacement: only cut off R3 from the plus line and use it for control. Peter Lindemann, DL7PZ

## DATV-News

W6HHC has published a report on several European DATV repeaters: GB3BH, GB3KM, GB3PV, DB0DLH and DB0SRS. This is written by Ken, W6HHC, and Robbie, KB6CJZ, and is downloadable at [www.w6ze.org/DATV/TechTalk80-DATV.pdf](http://www.w6ze.org/DATV/TechTalk80-DATV.pdf) worth reading!

## HDTV-News

ARD and ZDF starting regular HDTV service

With Olympic Games opening in Vancouver ARD and ZDF are cooperating at their production sites there. They are using the MPE (mobile production unit) containing various equipment utilized at other events before. Additionally ARD and ZDF have hired HD production and broadcast equipment from the Cologne specialist firm Wellen-Noethen, that was brought to Canada after configuration and testing (the same procedure will be performed at the Soccer World Cup 2010 in South Africa).

In Canada three more OB units and eleven editing units were hired from local services. The "International Broadcasting Centre" in Vancouver contains divisions from all broadcasters, ARD and ZDF are sharing a common production centre and live studio in turn day by day. At the German control centre there up to 22 video signals from the "Olympic Broadcasting Service Vancouver" (host-broadcaster) are routed, additionally exclusive camera and sound signals for ARD and ZDF viewers.

All video signals in Vancouver are produced in 1080i60 HD format; even the German cameras are using this in order to lighten the editing. Before the uplink to Germany the output video is converted to 720p50 by a device from "Snell & Wilcox" (ARD and ZDF HD standard is following the EBU recommendation from 2004, quote: "It will provide the lowest delivery bit rate for HD that satisfies the demands of the HD viewer, given the assumption that he/she has a Wide XGA display"). Personal ranking of Olympic HD channels from Vancouver

1. ARD and ZDF HD: in spite of questionable down-scaling balanced video quality from all sites including specials and replays, outstanding 5.1 surround sound, best direction efforts.

2. ORF1 HD: similar quality (720p50) like above, some specials only SD, lower 5.1 quality.

3. Sky Italia HD: five HD channels at a time in 1080i and 5.1 sound, replays only SD and 2.0 sound.

4. Eurosport HD: 1080i video not better than 720p, specials only SD, on Astra only 2.0 sound, ads interrupted.

5. 2Sport2: 10 HD channels from Russia with 90 percent 1080i, but only MPEG audio.

6. DR HD: Danish 720p channel with excellent 5.1 sound.

7. SVT HD: Swedish 720p channel showing some events only as SD replay, good 5.1 sound.

8. YLE HD: Finland with 1080i live, but no specials, only MPEG audio.

9. NRK HD: Norway like Finland, but less live events.

10. BBC HD: lower 1080i HD quality than some months before, specials only SD and with 2.0 sound.

11. France2 HD: live from Vancouver and studio in 1080i, specials only bad SD, 5.1 sound often mono.

12. HD Suisse: Swiss studio in Vancouver only SD, also specials (other times 100 percent 720p HD).





# Simple and cheap DATV for all

by John Ferrier GOATW

If we adopt DVB/T or DVB/S for amateur use there is a danger that the excessive cost of equipment will ostracize the majority of amateurs from taking part and restrict further development due to being locked into outdated compression methods.

The CCTV industry has had to develop digital wireless video technology that allows for various compression methods MJPEG, MPEG2, MPEG4 and H264 without compromising the transmission system and keeping costs to a minimum.

The answer is to use wireless IP (internet protocol) technology.

A typical digital RF link costs less than £100 plus an IP enabled video source and a PC system to display the image. Most amateurs have a PC in the shack and IP enabled cameras are now available at a similar cost to cameras with an analogue output. An alternative is to use an analogue Camera with a hardware codec to produce the network stream. Where possible choose a camera or codec that can be viewed directly from a web browser.

I have been conducting tests recently as part of my work and with local amateurs of one particular brand of wireless IP network transmitters.

The results so far seem to be very encouraging with equipment available for the 2.4 GHz and 5 GHz bands easily adapted to the amateur frequencies and very controllable RF bandwidth. The Ubiquiti Bullet with a "N" type aerial connector and the Ubiquiti Nanostation with built in aerial and SMA socket output. Power to the units 24V is via very cheap POE, power over ethernet injectors. Mounting is designed to be mast head directly into a long Yagi or dish aerials for amateur use the feed being CAT5 cable, so no lossy coax.

The phot below shows a bullet with RJ45 connector on one end an "N" connector



at the other and a signal strength bar graph on the side. The signal strength meter is also available on screen via a web browser in fact once you have established a RF link between two units you can look at the signal strength bar graph at both ends of the link.

Initial configuration is made by connecting to the Ethernet connector on your PC and using a web browser connect to the default IP address 192.168.1.20 Prior to this set your PC for a static IP on the 192.168.1.x subnet.

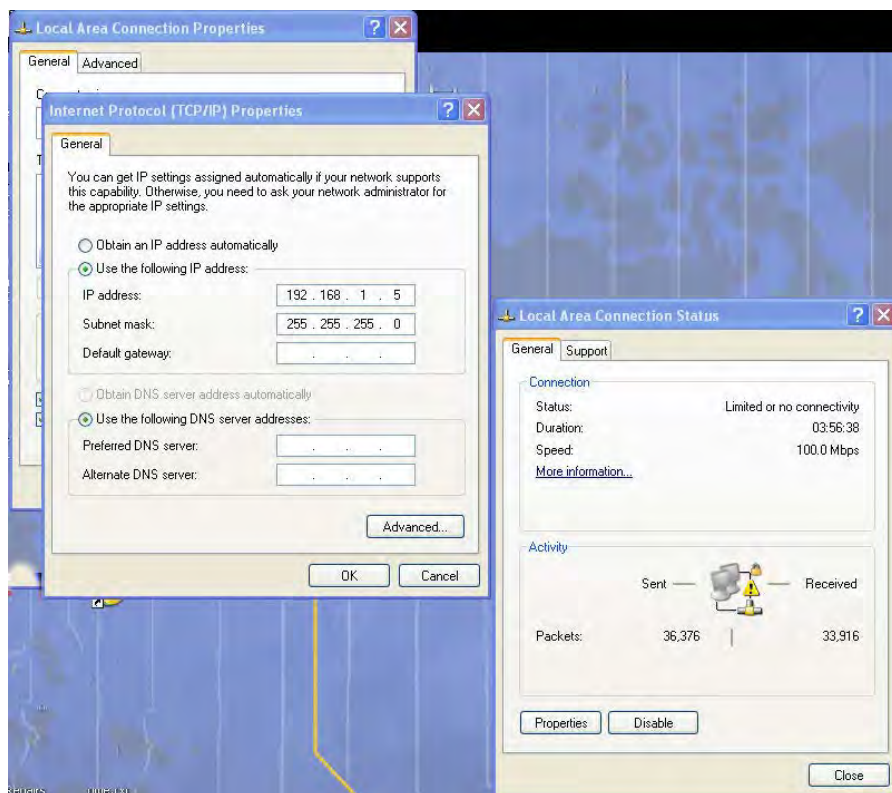

For a simple point to point contact set one unit as an access point and the other as a station. To use in the amateur band away from other WiFi users put the units into compliance test mode, select a suitable frequency or frequencies and RF bandwidth, 5 MHz gives the best range and very good pictures with most compression types. Note if compliance test mode is not available on your unit upgrade the firmware to the latest revision, instructions are available on the manufactures WEB site.

Figure 1 shows the setup screen of the unit in access point mode with compliance test in the country code tab. The screen shot is from the 5 GHz version with full coverage from 5 to 6 GHz. Figure 2 shows the channel selection screen in the station mode. The simplest way to identify yourself is to use your callsign as the SSID.

Once you have the access point and station configured they should automatically connect to each other when in range.

Figure 3 shows the on screen signal strength bar graph. Plug an IP enabled camera into the station and the access

point into your PC you should be able to direct your web browser to the cameras IP address and view its picture, you may be prompted to download and run an Active X plug-in at this point allow this, it is used to software decode the cameras video stream.

A useful supplier with very helpful customer support is MS Distribution they have a web site at <http://www.msdist.co.uk>



Figure 1

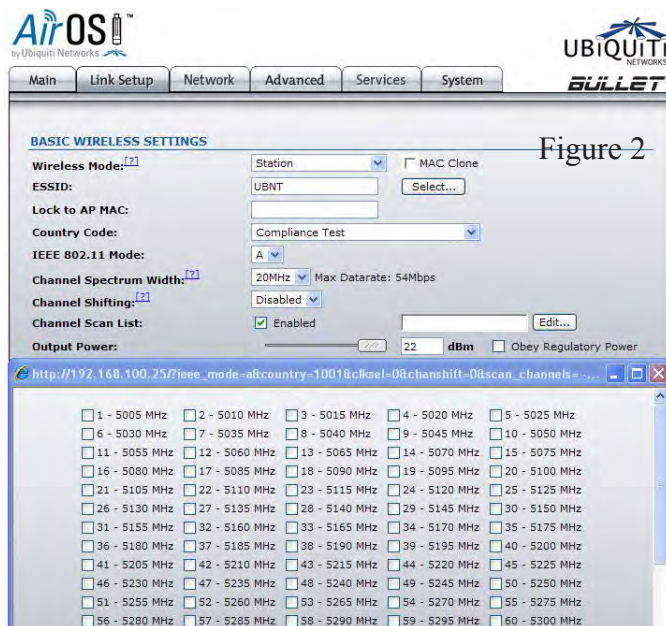

Figure 2

Small power amplifiers up to 1 Watt are available on eBay. Using a borrowed Axis Q1755 I recently managed to transmit a 16x9 High definition MJPEG picture over a 24cms IP link. I did try in H264 but my computer is fairly slow and the delay in decoding the stream made it unusable after a short period.

Once established as a popular mode of digital TV transmissions, repeaters can be simply an access point and nationwide network linking or a wireless amateur cloud could be established.

This article is intended as a starting point I hope others will add input on the technicalities of networking and building or modifying equipment to work with wireless IP networks on amateur bands.

Other useful reading is available at <http://www.qsl.net/kb9mwr/projects/wireless/plan.html> which is very American biased but full of information and links.

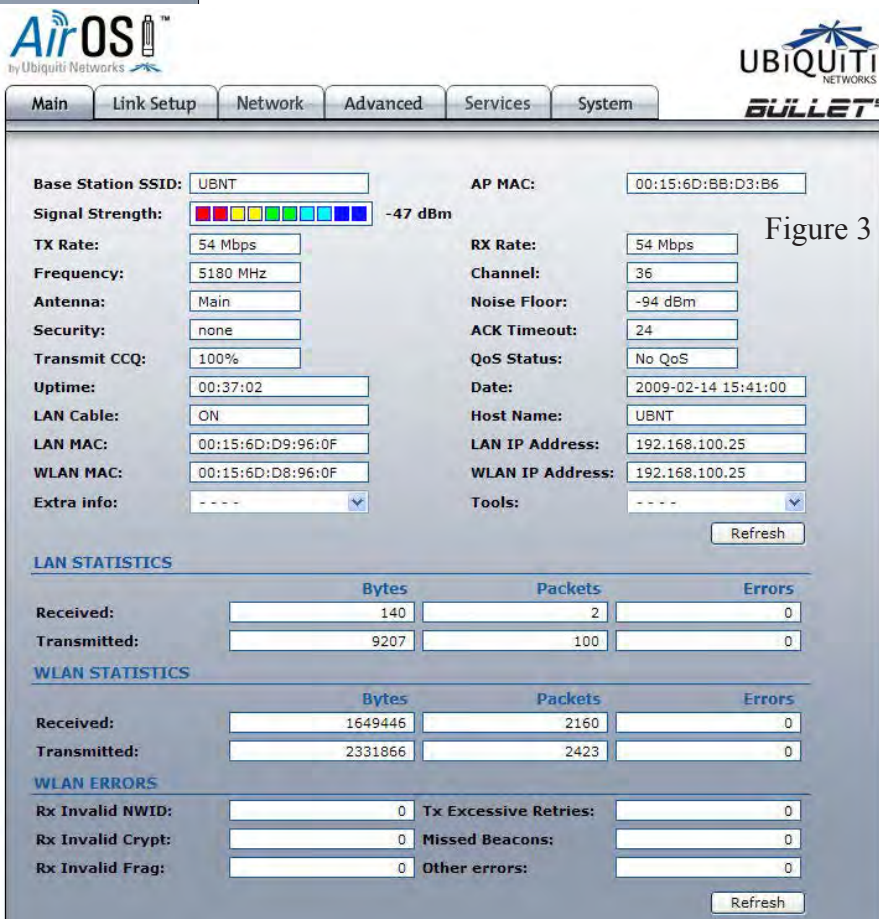

Figure 3

## !!! Your Club Needs You !!!

If you do something, anything, related to ATV please drop your editor an email so it can appear in CQ-TV, if you can write an article about your latest project even better!

[editor@batc.org.uk](mailto:editor@batc.org.uk)



# Contest News

## March Repeater Contest

I received entries for the March Repeater Contest from 5 of the 14 stations who were active. Those who appeared in the logs but did not enter included G8XTW, G4WYO, M0SAT, G4CPE, G8MNY, G6OUA, G6MNJ, M0DTS and G3YWG. Thanks to all those that participated. The results are shown on the right.

Congratulations to Dave, G8ADM, whose high score was mainly down to his persistence in getting others on to the air!

## Repeater Contest Scoring

I have often been asked how to correctly score entries for the Repeater Contests. I realize it is a complex art, and so have been happy to correct scores without penalty. My philosophy is that the Repeater Contests exist as a bit of fun to promote activity – it's not the winning that's important, but the taking part!

Here's how I work out the scores:

1) For each direction of each contact, work out the length of the "entrant to repeater" path. Multiply the distance in kilometers by the appropriate one-way band multiplier:

70 cm: 1  
23 cm: 2  
13 cm and above: 5  
Internet: 0

## Contest Calendar

1200 UTC 12 Jun 2010 - 1200 UTC 13 Jun 2010 - BATC Summer Fun Contest  
1800 UTC 11 Sep 2010 - 1200 UTC 12 Sep 2010 - International ATV Contest  
1200 UTC 11 Dec 2010 - 1200 UTC 12 Dec 2010 - BATC Repeater Contest  
1200 UTC 26 Mar 2011 - 1200 UTC 27 Mar 2011 - BATC Repeater Contest

## BATC Repeater Contest 20/21 March 2009

Place	Call	Points	Locator	QSO	Repeaters
1	G8ADM	1830	IO91TO	9	GB3BH, TV and TZ
2	GW3JGA	1168	IO83HI	4	GB3TM
3	G7LRQ	910	IO91TQ	7	GB3BH, TV and TZ
4=	GW4KAZ	628	IO73VE	4	GB3TM
4=	MW0AQZ	628	IO73QH	4	GB3TM

2) For each direction of each contact, work out the length of the "repeater to station worked" path. Multiply the distance in kilometers by the correct band multiplier above.

3) Repeat this for the reverse direction (if 2 way) and add the 4 figures together.

I also apply the following ground rules:

4) Repeater contests are single-section (as many contacts are now cross-band), and receive-only stations are included in the same section.

5) Repeater to Repeater links and Repeater to Internet links are considered part of the Repeater infrastructure and do not count for points (even if the station entering provides the link!).

Congratulations to Anthony G7LRQ who correctly scored his entry to the March contest!

## Contest Times

Note that BATC TV Contests start at 1200 UTC so that Portable stations can operate in daylight on Saturday afternoons. However, the September IARU Contest will start at the original time of 1800, as the timings are set by the IARU.

## Future Contests

Don't forget the conventional contests: the BATC Summerfun in June, and the IARU Contest in September. Please try to get on the air in at least one of these!

## Contact Details

I can be contacted through e-mail (contests@batc.org.uk), or through my BFPO address: Wg Cdr D G Crump, Mailbox Number ACT, BFPO 63, London. As I am due to move house (to a different continent) in the next few months, please make sure that you get an e-mail acknowledgement from me for contest entries. My e-mail address will not change; I should be able to publish my new postal address in the next issue.

## Last Word

It helps me if you can submit contest entries in Excel 2003 format (or older). I have not updated to Excel 2007 yet.

**We are still looking for a co-editor as well as a "graphic designer" to produce the covers. Please contact: [editor@batc.org.uk](mailto:editor@batc.org.uk) if you are interested in either position.**

# BATC Publications and Members Services

Publications	Each	Qty	Total
<b>An Introduction To Amateur Television (225gm)</b> The latest handbook full of detailed information on how to set up your ATV station, plus lots of new video and RF construction projects. The BATC handbook featuring construction articles on video units, 24cm and 3cm ATV, a Digital Frame Store, and much more.	£2.50	.....	.....
<b>The Best of CQ-TV (150gm)</b> A compilation of the best construction articles from CQ-TV's 133 to 146	£3.50	.....	.....
<b>CQ-TV Back Issues:</b> The following issues are still available. Please circle those required: 185,186,187, 188,189,190,191,192,193,194,195,196,197,198,199,200,201,202,203,204,205,206, 207,208,209,210,211,212,213,214,215,216,217,218,219,220,221,222,223,224, 226, 226	£1.50	.....	.....
<b>Special Offer: Any four of the above issues</b>	£5.00	.....	.....
227,228,229,230	£3.75	.....	.....
<b>The BATC DVD</b>	£5.00	.....	.....

**All publications can be ordered, with a credit card, via our online shop - [www.batc.org.uk](http://www.batc.org.uk)  
Or by sending a cheque made out to 'BATC'**

*All items appearing in Members Services from previous editions, can still be ordered (subject to availability). Please see page four for contact details. Several items are still on sale, so please check for the latest pricing before sending a cheque.*



[www.nonanet.co.uk](http://www.nonanet.co.uk)  
[sales@nonanet.co.uk](mailto:sales@nonanet.co.uk)

**Nonanet (UK) Limited are a UK Internet Services Provider**

We specialise in providing bespoke hosting solutions, some of our services include:

- Web design & hosting
- Programming
- Consultancy
- Email services
- DNS hosting
- SEO work
- VoIP Services
- Send/Receive text messages from your desktop
- SMS short-codes (premium or standard rate)
- SMS API via SMPP/HTTP/SOAP/Email
- Bespoke SMS services
- Low cost bulk SMS
- Low cost premium route SMS

Contact us on: 01844 220022 or [sales@nonanet.co.uk](mailto:sales@nonanet.co.uk)  
We will provide free hosting services to any project involving ATV  
whether for the individual, club or repeater group  
Contact us for details



# Turning back the pages

A dip into the archives of CQ-TV, looking at the issue of 50 years ago.

by Peter Delaney

CQ-TV 44

The Editor, John Tanner, had been away from home for some time, and so this issue of CQ-TV was somewhat delayed. It does not have a date to it, but appears to have been produced about a year after CQ-TV43. For that reason, this series is no longer looking at the issue of '50 years ago' !!

The photographs all related to the exhibits at the amateur television convention, held in London in September 1960. The telecine equipment had been built by Bob Tebbutt, using a modified 9.5mm projector arranged for flying spot scanning. The scanning crt is just left of centre, with the projector towards the right. It would have had the photo detector located where the projection bulb would have been originally, using the optical system 'in reverse'. Slow scan equipment on display included that by 'Pluff' Plowman. The top of the rack contained a slow scan monitor, with the middle section housing the photocell (at right hand end), amplifier and a subcarrier generator. At the bottom were the scan generating circuits and the crt used for scanning (set vertically, with the faceplate uppermost, to the right hand end). John Tanner had built a new vidicon camera, and was seen showing it to Grant Dixon (left) and Don Reid (middle). Other exhibits at the convention included 2 image orthicon cameras and an iconoscope based one, various items of signal or pulse generator - including a colour bar generator (working to NTSC standards).

There was also a monoscope built by Graham Hill, and this formed the subject of the major technical article in CQ-TV44, as the results seen at the Convention were said to be 'outstandingly good'. The circuitry was of interest as it used the (then) modern high slope valves, which although more expensive than the more common types, resulted in fewer being needed for the same output.

The equipment was designed to make best use of the monoscope tube's resolution. Traditionally, that would have required the use of peaking coils in the anode loads, but feedback in V1 and the high peaker stage V3 enabled adequate high frequency response without an 'overshoot'. The circuit around V4 was to blank the signal during the time when the monoscope scanning beam retraced its position to start a new line or field. V6 was a gain control and phase reversing stage, and V7 was the output stage, for feeding to a vision mixer (or to a separate unit to add the standard blanking and sync pulses). The monoscope tube was provided with an eht of 600V derived from a 450V winding on the mains transformer. Although below the recommended eht of 1kV, 'the results indicate that it is adequate'. The bias on the tube's final anode was made positive, by a feed from the 150V stabilised supply, so that any secondary electrons liberated from the target were removed without affecting the output signal. The second diagram showed the scanning circuits - the vertical drive being at the top and the horizontal drive below. Both sections had a valve acting as a sync separator (V8 and V11), so that if separate line and field sync signals were not available, each scanning circuit could be triggered from mixed sync pulses looped through the input pins.

Another major event of the year had been the RSGB Convention. Ian Waters G3KKD/T arranged for a half hour demonstration programme of atv to be transmitted from the station of Jeremy Royle, G3NOX/T. There were 3 cameras and a monoscope to feed Jeremy's vision mixer. The transmissions took place on 70cm over a 12 mile path to the centre of Cambridge - but later reports showed that the programme was also received by G3OAT/T who was a further 20 miles distant. The East Anglian group had also set two new records - firstly transmitting 625 line pictures over a 49 mile path from G2WJ/T in Dunmow to G3OAT/T in Huntingdon, and secondly the sending of signals from G3KKD/T

to G3GDR at Abbots Langley - a path of 80 miles, by relaying the transmission through G3NOX/T and then through G2WJ/T. (*This was long before the development of the network of atv repeaters, of course*).

A shorter technical article described a distribution amplifier, with an unusual output stage - a shunt regulated cathode follower. V2a was a conventional cathode follower, with V2b's grid fed with a sample of the current across V2a's load resistor. The advantage was said to be that it could deliver about twice the normal current of a cathode follower, but with less non-linearity. It was explained that the two sections of V2 in effect operated in parallel, so far as the current in the load was concerned, and as the part done by V2b depended on the load current, not voltage, it made it insensitive to stray capacity, and worked as an output stage with low output impedance. The rest of the article explained the way the component values were chosen, and the importance of correctly terminating the input and the 3 outputs before making the adjustments. (*True for all video amplifiers!*)

The 'What The Other Chap is Doing' pages included several 'familiar names'. Derek Whitehead had been at the BATC Convention, having travelled from the Arctic via Montreal. "When he is at home in Llandudno", the magazine reported, "he and John Lawrence GW3JGA/T of Prestatyn run a two way vision link". As CQTV 227 reported, both Derek and John are still active tv amateurs in North Wales. Grant Dixon in Ross-on-Wye was well equipped for 70cm reception, and had been in touch with Malcolm Sparrow G3KQJ/T of Wolverhampton. Several members were 'in the forces'. Arthur Critchley, in Doncaster, had put on a static camera demonstration at the RAF Open Day attended by 5000 people. His advice to others planning demonstrations included "rope off the entire equipment, have super definition viewfinder, raise camera above the heads of annoying small boys!". An atv group at RAF Locking was building a

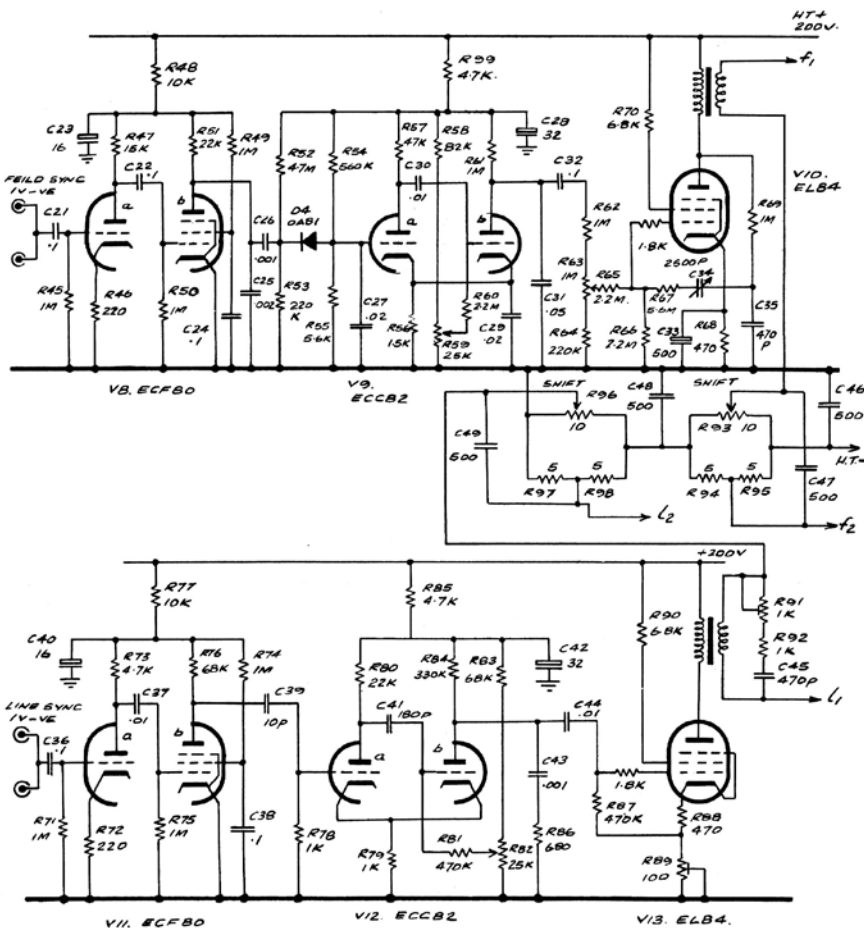
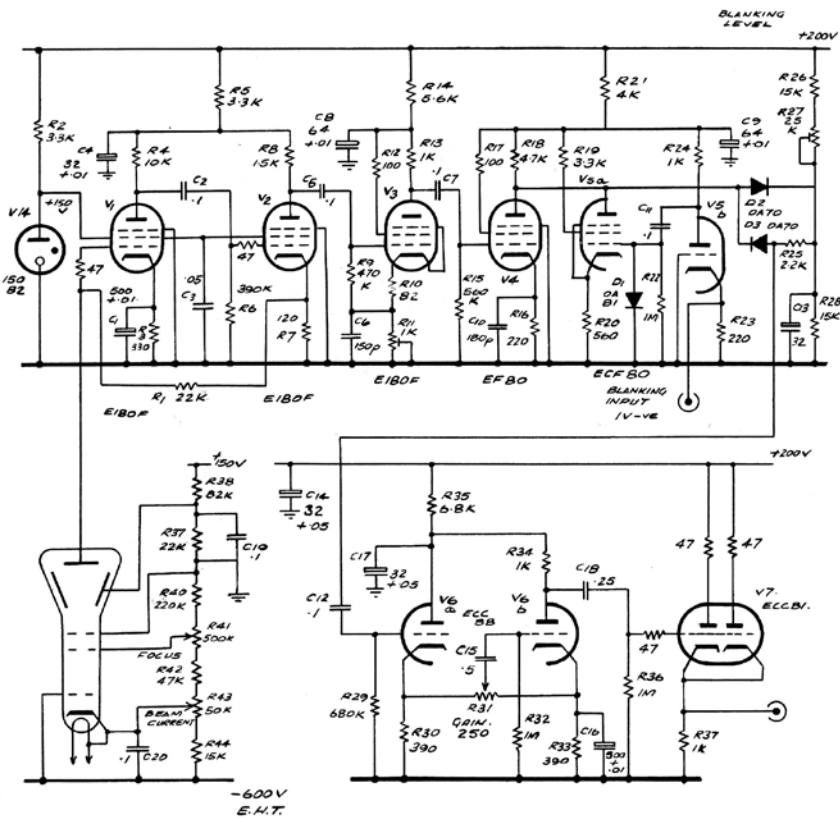

transmitter, “despite the loss of their UHF expert (complete with their circuit!)”. Stan Crouch from Tolworth was building a sync generator and mixer, but “as he is in the forces at the moment, there isn’t much time for atv”. Lewis Elmer, from Warrington, was also ‘in the forces’, at Portsmouth, and was looking to receive 70cm signals in the area, whilst I Miles, in the Royal Navy in Cornwall was looking for books on John Logie Baird’s work. Two members had been lucky in the raffle held at the BATC Convention. Mick Cotter had won an EMI vidicon, and was “winding his scan coils, and learning all he can about vidicons”, whilst W Thacker from Burwell “was delighted to win an EMI photomultiplier as he has recently been experimenting with a flying spot scanning system”. The last section of ‘What The Other Chap is Doing’ was headed ‘Slow Scan Corner’. It began by saying that “there is now so much activity and interest in slow scan tv that Pluff Plowman suggests a separate corner for slow scan news. To those who are tired of reading about slow scan, may we point out that the remedy is in your own hands, lets hear more of colour, flying spot scan, cameras, RF, aerial arrays, etc”. (*Several years later, there were complaints that there was not enough slow scan in CQ-TV !! The editor’s reply was much the same -- if you want more of ‘your favourite topic’, then write something about what you are doing. I suspect our present editor would say exactly the same).*

Slow scan activity in the USA came from Don Miller, W9NTP - quite a few people were collaborating with Cop Macdonald WA2BCW in New York. In the UK, Pluff Plowman had improved his video amplifier since the Convention, but was having optical problems due to reflections from glossy postcards that were being scanned. In the Manchester area, Gordon Sharpley and Brian Green had been attending exhibitions and demonstrating slow scan tv to a wider public.

Despite the absence of CQ-TV for a while, therefore, amateur television activity seemed to be thriving in various areas of the country - in video or rf, slow scan or fast scan, construction or operating.



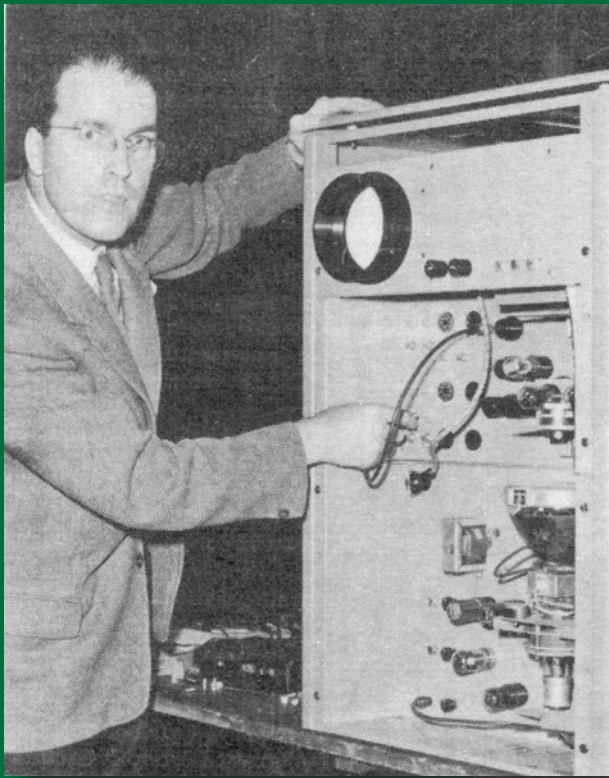

Slow Scan  
by 'Pluff' Plowman

Vidicon camera  
by John Tanner (right) with Grant  
Dixon (left) and Don Reid (middle)



Telecine equipment  
built by Bob Tebbutt

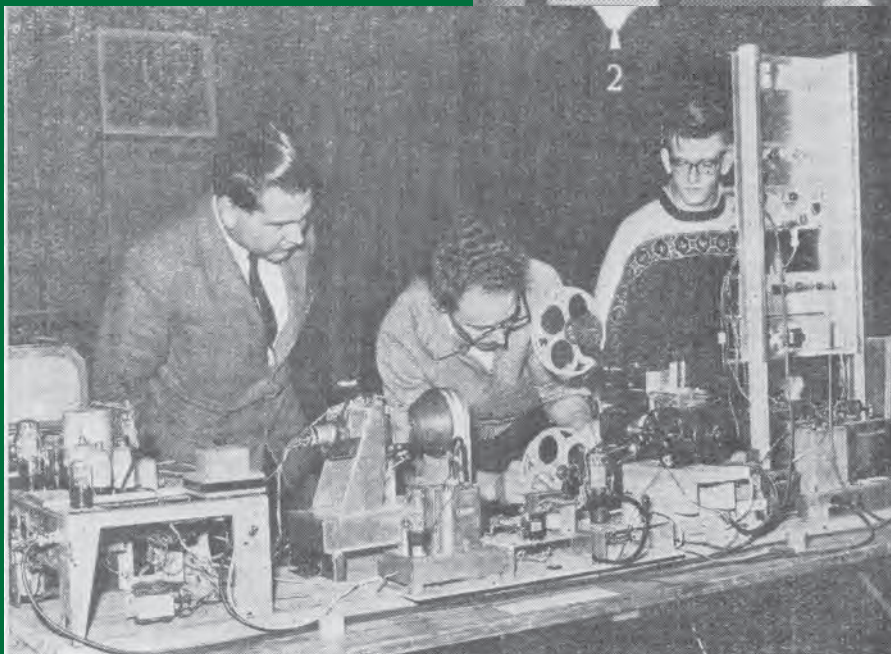





**Our Hon. Treasurer  
at the RSGB AGM**



**Our esteemed Chairman  
at the RSGB AGM**

**RSGB AGM, where the Kenwood Trophy for outstanding contribution to amateur radio training was awarded to the Bath Buildathon team. All six got certificates of merit - Mike Coombs, G3VTO, Lewis Thomas G4YTN, and Steve Hartley G0FUW, the mentors, Robin Thomson.**

**The full video can be found in the archive section of the streamer [www.bate.tv](http://www.bate.tv)**

**Picture courtesy of the RSGB**

