

# Contents

Contents ..... 1

Committee Contacts ..... 2

Chairman’s Column..... 3

Contest News ..... 3

From the President’s Desk ..... 5

Circuit Notebook No. 72 ..... 7

G1MFG’s ATV Modules Reviewed ..... 9

Members only! ..... 11

Home Video ..... 12

Subscription rates ..... 18

CQ-TV Commercial advertising rates ..... 18

The Quest for Just That Little Bit More at 13cm..... 19

Two stage 2400 MHz power amp ..... 21

Putting you in the HD picture ..... 22

Masthead power ..... 23

Deadline..... 23

Flying high ..... 23

Members’ Services ..... 24

BATC Publications ..... 25

Satellite TV News ..... 26

Is your Subscription due? ..... 29

The STV5730A Character Generator Chip..... 30

Mobile ATV in Snowdonia..... 31

More Portable ATV Success..... 32

CQ-TV Wins Award in ‘Spotlight’ Competition!..... 34

Comments from the Membership Secretary ..... 34

Live from MIR..... 35

ET Video Home ..... 36

TFT LCD.com monitors reviewed ..... 38

The Story of GB3GW..... 42

Newsflash..... 43

Post and News ..... 45

Contest calendar..... 45

Members adverts..... 46

For Sale..... 46

Wanted..... 47

Problems in Germany ..... 47

Index of Advertisers..... 48

Edited by Ian Pawson, circuits drawn by Allan Robinson, proof read by Peter Delaney. All rights reserved, all wrongs denied.

**Copyright © 2000 by the BATC and contributors.**

**Legal Niceties (the small print)**

E&OE. Whilst every care is taken in the production of this publication, the editor accepts no legal responsibility for the advice, data and opinions expressed. The BATC neither endorses nor is it responsible for the content of advertisements or the activities of those advertisers. No guarantee of accuracy is implied or given for the material herein. The BATC expressly disclaims all liability to any person in respect of anything and in respect of the consequences of anything done or omitted to be done wholly or partly in reliance upon the whole or any part of this magazine.

The contents of this publication are covered by international copyright and must not be reproduced without permission, although an exception is made for not-for-profit publications (only) wishing to reprint short extracts or single articles and then only if acknowledgement is given to CQ-TV.

Apart from any fair dealing for the purposes of published review, private study or research permitted under applicable copyright legislation, no part of this publication may be reproduced, stored in a retrieval system or transmitted in any form or by any means, electronic, mechanical, photocopy, recording or otherwise, without the prior permission of the publisher. All copyrights and trademarks mentioned in this publication are acknowledged and no infringement of the intellectual copyright of others is intended. Printed in Great Britain. ISSN 1466-6790

**Notice to Contributors**

Authors are alone responsible for the content of their articles, including factual and legal accuracy, and opinions expressed by them may not reflect the editorial stance of the publication. Material submitted to CQ-TV should not infringe the copyright of other writers or bodies. Articles remain the copyright of their authors and following publication in CQ-TV, they may also appear on the BATC's web site and CD-ROMs, also in other not-for-profit amateur publications. Contributions are accepted for publication on this basis alone.

Printed by Clipper Print Ltd., Unit 13, East Goscote Ind. Estate, East Goscote, Leicester, LE7 3XJ, England. Telephone: 0116 260 9909.

---

## Committee Contacts

---

**President: Mike Cox, CEng., FIEE**

**Chairman: Trevor Brown, G8CJS**

Club affairs, Video tape library, Technical queries, especially relating to handbook projects. 14 Stairfoot Close, Adel, Leeds, LS16 8JR. Tel: 01132 670115. E-mail: [chairman@batc.org.uk](mailto:chairman@batc.org.uk)

**General Secretary: Paul Marshall, G8MJW**

General club correspondence and business. Library queries relating to the borrowing or donation of written material. Fern House, Church Road, Harby, Notts., NG23 7ED. Tel: 01522 703348. Email [secretary@batc.org.uk](mailto:secretary@batc.org.uk)

**Hon. Treasurer: Brian Summers, G8GQS**

Enquiries regarding club finances, Donations, and constitutional enquiries. 9 Prior Croft Close, Camberley, Surrey, GU15 1DE. Tel: 01276 677879, Mobile: 0797 0417875, Email: [treasurer@batc.org.uk](mailto:treasurer@batc.org.uk)

**CQ-TV Magazine: Editor Ian Pawson**

Anything for publication in CQ-TV, Articles, Review items, Letters to the editor, and other material except as below. 14 Lilac Avenue, Leicester, LE5 1FN, England. Tel: 0116 276 9425, Email: [editor@cq-tv.com](mailto:editor@cq-tv.com)

**Photographs for the CQ-TV covers:** - Please send any photographs by post, electronic images by email, to the editor at the above addresses.

**TV on the Air:** - Graham Hankins G8EMX, 17 Cottesbrook Road, Acocks Green, Birmingham, B27 6LE. Tel: 0121 706 7384

**Satellite TV News:** - Paul Holland G3TZO, Chatterton, Chapel Lane, Threapwood, Nr. Malpas, Cheshire, SY14 7AX. Tel: 01948 770429, Email: [satnews@batc.org.uk](mailto:satnews@batc.org.uk)

**CQ-TV Advertising Manager:** - Trevor Brown, 14 Stairfoot Close, Adel, Leeds, LS16 8JR. Tel: 01132 670115. Email: [adman@batc.org.uk](mailto:adman@batc.org.uk) Members adverts for inclusion in CQ-TV should be sent directly to the editor and the above address, either by post or e-mail.

**CQ-TV Awards:** - Bob Webb G8VBA, 78 Station Road, Rolleston on Dove, Burton on Trent, Staffs., DE13 9AB. Tel: 01283 814582

### Exhibitions

Graham Hankins G8EMX, 17 Cottesbrook Road, Acocks Green, Birmingham, B27 6LE. Tel: 0121 706 7384 Email: [exhibitions@batc.org.uk](mailto:exhibitions@batc.org.uk)

### Club Sales

**Members Services:** - PCB's, components, camera tubes, accessories, etc. (NOT PUBLICATIONS). Peter Delaney, G8KZG, 6 East View Close, Wargrave, Berkshire, RG10 8BJ. Tel: 0118 940 3121. Email: [services@batc.org.uk](mailto:services@batc.org.uk)

**Publications:** - Handbooks, Back copies CQ-TV, and anything related to the supply of BATC publications. Paul Marshall, Fern House, Church Road, Harby, Notts., NG23 7ED, England. E-mail: [publications@batc.org.uk](mailto:publications@batc.org.uk)

### Membership

Anything to do with membership, including new applications, queries about new and existing membership, non-receipt of CQ-TV, subscriptions, membership records, data protection act. Dave Lawton, G0ANO, 'Grenehurst', Pinewood Road, High Wycombe, Bucks., HP12 4DD. Tel: 01494 528899. E-mail: [memsec@batc.org.uk](mailto:memsec@batc.org.uk)

**Club Liaison:** - And anything of a political nature, co-ordination of ATV repeater licences. Graham Shirville, G3VZV, The Hill Farm, Potsgrove, Milton Keynes, Bucks., MK17 9HF. Tel: 01525 290343. E-mail [g3vzv@amsat.org](mailto:g3vzv@amsat.org)

**Contests:** - Richard Parkes, G7MFO, 7 Main Street, Preston, Hull, HU12 8UB. Tel: 01482 898559. Email: [contest@batc.org.uk](mailto:contest@batc.org.uk)

### CQ-TV and BATC web masters

Anything to do with the CQ-TV web site Email: [webmaster@cq-tv.com](mailto:webmaster@cq-tv.com) or for the BATCs web site. E-mail: [webmaster@batc.org.uk](mailto:webmaster@batc.org.uk)

---

## Chairman's Column

---

Let me start by welcoming our new BATC president Mike Cox. Some of you know him only by his articles in CQ-TV, but Mike has been a big part of the Broadcast Television equipment industry and a keen supporter of BATC. With the election of a new president it is time to say good-bye to the retiring president, Arthur C Clarke and I would like to take this opportunity to thank him for lending his support to BATC. The original appointment was for a two-year term of office and I am afraid we have over stayed our welcome a little, sorry, Arthur. I would like to thank you on behalf of all BATC members for your support. Sorry, I did not believe it was you on the phone - you would not believe some of the calls I get.

CQ-TV has won the Practical Wireless Spotlight Competition (National Category) for its excellence as a technical publication. We all know how good CQ-TV is, but it is good to receive recognition from others. Rob Manion, the PW editor, rang with the news this week and it is hoped to

present the award at the Leicester show (as I write this) next week. For those of you that have not seen the award, it is called "Bert's Bell" and I hope we can have it on show at some of the rallies around the country and at Bletchley next year. The previous winner was R.I.G. (Remote Imaging Group).

David Andrews has been working hard on expanding the CD ROM by scanning and converting more back issues of CQ-TV. Bob Platts has been spanning the North Sea again on 10 GHz with P5 pictures both ways. This time from Southwold in East Anglia across to West Koppelar, in west Holland, and Hans PE0ECO and Peter PE1DCD near Rotterdam. The following day Bob moved to Bridlington and again re-established contact with Hans and Peter; at times signals were so strong as to produce P5 picture without an antenna attached to the LNB. See the front cover of this issue for pictures, whilst a full report has been promised for the next issue. Sales of CQ-TV ad space seems to be increasing with almost all the colour

space in this issue being bought by advertisers. We are trying to back the advertised products up by reviews. I think it is important that the equipment being advertised is reviewed wherever possible, although I am aware that this issue carries three reviews.

It's interesting that the number of small ads seems to be declining. A lot that hit the editors desk are marked for web site only - I am not sure why, but for those of you that enjoy the members for sale and wanted ads, I can only point you at the web site. Whilst on the subject of the website, Ian Pawson is investigating installing a shopping trolley option that will make buying via our web site a little easier. The problem seems to be that the package is written in Pearl and needs customising to our needs, so Ian is on a learning curve at the moment and I am sure he will triumph - just keep watching our web site.

**Trevor Brown, BATC Chairman**  
email: [Chairman@batc.org.uk](mailto:Chairman@batc.org.uk)

---

## Contest News

---

### By Richard Parkes G7MFO

First of all I would like to thank two amateurs who have answered my 'Urgent' request in the last CQ-TV. Ken Stevens G4BVK and Bill Hall G3RMX for producing an excellent automatic contest log sheet in excel which can be used 'live' in a contest or filled out later. It automatically works out the beam heading, distance worked total score etc. It can be downloaded from the BATC web page. The contest log sheet was tested by myself over the International contest and worked without fault.

I'm writing this article just after having a very enjoyable weekend portable taking part in the International contest. I won't go on about the problems I had putting up the station except the burst

tyre on the caravan, taking it up onto the contest site on the Friday night (no spare), the generator I borrowed fluctuating between 200 -270v (found out it had not run in over 18months) and finding out I had the wrong rotator controller for the rotator. I would like to thank all the people I worked over the weekend and the people who help me get the station up and running.

The main problem I had over the weekend was after establishing a contact on the call frequency 144.750MHz was finding a clear frequency on 2m to continue the contact. Don't forget to listen around 144.170MHz on SSB.

I have received three entries for the International, sent to me in the week after the contest. I hope more will

arrive on the doormat? Or via e-mail, before I send the results to the RSGB. Please send in your contest results even if you only work one station one way. The above spreadsheet will make it a lot easier to submit your log via e-mail or snail mail.

See below for the information you have all asked for, the next contest dates. Don't forget to look on the BATC web page for the contest results and the latest information.

**Richard Parkes G7MFO 7  
MAIN STREET, PRESTON,  
HULL. HU12 8UB.  
ENGLAND. Tel:- 01482  
898559**

E-mail: - [contest@batc.org.uk](mailto:contest@batc.org.uk)

---

*Due to pressure on space, part 4 of the 'Introduction to PIC programming' has been held over to the next issue - ED*

# Severnside Television Group

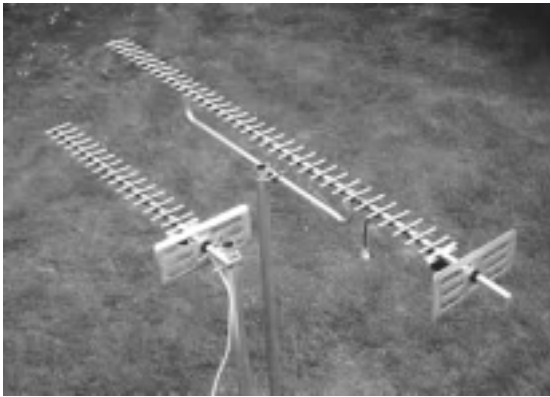

Our 23cm aerials are specifically designed for ATV use, although they can be used for other modes as well. Wideband characteristics mean that you need only one aerial to cover the repeater input and output channels. Our famous wideband yagis come fully assembled in two versions:

**38-ELEMENT HIGH-GAIN:** 14dB gain, 1.8m long, **£26.00** plus p&p.

**18-ELEMENT STANDARD:** 10dB gain, 0.9m long, **£15.00** plus p&p.

Don't forget our **20-ELEMENT CONVERSION KIT**, which converts your existing 18-element aerial to the full 38-element high-gain specification: **£13.00** plus p&p.

Our aerials feature an SWR of less than 1.5:1 and are supplied with mast clamps suitable for masts up to 55mm diameter (mast poles are not supplied).

**Postage and packing: £4.00 per aerial.** Postage to the UK only.

Cheques should be made payable to "**SEVERNSIDE TELEVISION GROUP**" and sent to:

**S.T.G., 3, Beechwood Drive, Penarth, Vale of Glamorgan, CF64 3RB.**

## S. Marshall

20dB gain 10GHz horns      **£25.00**

Waveguide 16 and 17 flanges      **£5.00**

Slot antennas and filters made to order.

For further information, contact: -

**S. Marshall, G6NHG,  
25 Carlcroft,  
Stonydelph,  
Tamworth,  
Staffs., B77 4DL.**

**Telephone: 01827 897920. 7:30pm - 10pm  
weekdays.**

**Fax: 01827 702434**

**Email: [g6nhg@qsl.net](mailto:g6nhg@qsl.net)**

## HS PUBLICATIONS

7 Epping Close, Derby DE22 4HR, England  
☎ 01332 38 16 99



- DX-TV CONVERTERS • VHF-UHF TV AERIALS
- DX-TV PUBLICATIONS & VIDEOS
- AMPLIFIERS • FILTERS • HARDWARE
- TECHNICAL BOOKS
- BBC TEST CARD MUSIC C.D's
- TV CLOCKS & ARCHIVE PUBLICATIONS

Send 3 First Class stamps for our latest Catalogue  
Personal callers by prior arrangement only please.



---

## From the President's Desk

---

**By M. H. Cox, CEng., FIEE**

Your Committee has done me the honour of asking me to be President for the next two years. It is a particular honour to be following in the footsteps of Arthur C. Clarke, although I cannot lay claim to his gifts of prophecy. It is also an honour to be following John Ware, Boris Townsend (my old boss!), Neville Watson and Ivan James (who provided some dichroic mirrors when I was building my colour camera [qv]). I have known all these for many years and they have made a great contribution to our industry.

I understand from Trevor Brown that there are no particular duties for the President to carry out; however I shall probably write the odd article for CQ-TV, and do my best to attend the AGM. If any of you have equipment bearing my name, and you have a problem, get in touch. I may not be able to help straight away, but could well know someone who could. There is a rumour that I may get on e-mail one day - this would please my IBC colleagues, but until then you can always fax me. Some of you might be interested in a bit of history from an old hand in the industry. In which case, read on.

I joined the BATC in 1955 while a student at UCL. First equipment was a flying spot scanner using 5FP7/931A combination, shown at Convention in 1955. Leaving UCL, I went to Marconi in Chelmsford as a graduate apprentice. A group of us used Mike Barlow's (Editor CQ-TV at the time) garage as a shack.

Mike was a transmitter man, and our "rent" was to give him some pictures to transmit.

I joined Rediffusion at Wembley Studios in 1959 as a studio maintenance engineer, and built an iconoscope camera (5527) along the way, as well as an early transistor SPG/TSG. (Described in CQ-TV 48)

In 1961 I joined ABC Television at Teddington Studios, initially as planning engineer, then as ITV's only colour development engineer for some years.

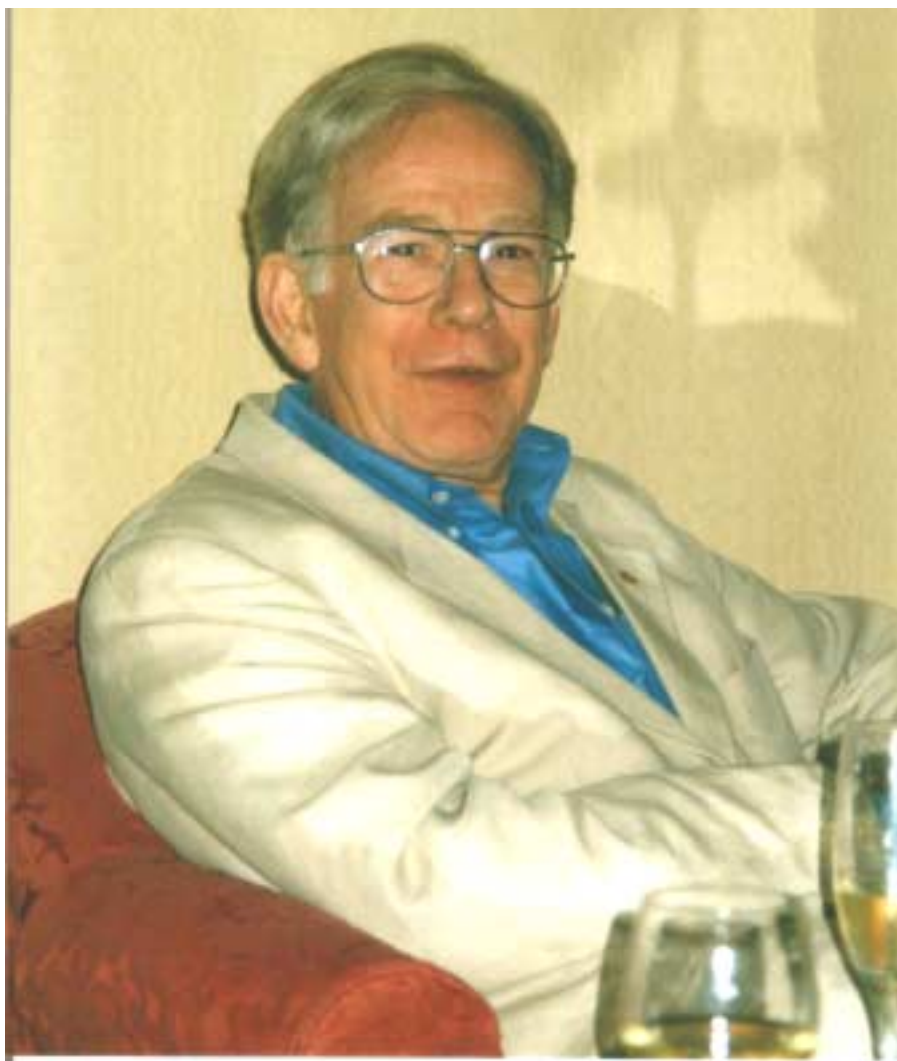

**The man himself**

I was involved in investigations and demonstrations of NTSC, PAL, SECAM and NIR colour systems on 405, 525 and 625 lines. This was an amazing time. I was working with Howard Steele, who went on to be Director of Engineering at the IBA, and subsequently to start Sony Broadcast in Basingstoke. It was a great loss to the industry and to his family and friends when he died so young in the mid 80s.

While Howard was at ABC, he persuaded the ABC Board in 1961 to invest some money in colour investigation. There was no point in replicating the work that the BBC were doing on NTSC, and the recently proposed SECAM system looked as if it had merit as an alternative system. Howard was then invited to join the EBU Ad Hoc Group on choice of a colour television system for Europe.

We gave demonstrations of various aspects of SECAM in the Studio to EBU and CCIR groups. The first ever SECAM vision mixer was demonstrated during this time, as was recording on the monochrome (RCA TR22) VTRs installed at Teddington. Because we were a small team, we all got to meet the great and good of European Television. We also got to make a lot of the equipment because it was not available commercially.

We also used to give colour TV demonstrations to the Post Office to support a series of lectures they were giving around the country. They had to get a SECAM feed because there was no way that NTSC (from the BBC) would have travelled on the video circuits of the time. Our sources were a Cintel polygon 35mm flying spot machine, and a crude colour caption



**3-vidicon colour camera for CQ-TV 60**

facility consisting of my home built vidicon camera and a colour synthesiser, which was the prototype, of what was later known as the COXBOX. This name was given to it by a German customer (ZDF), who bought one of the first units, and it stuck!

One of the cameramen at Teddington was an excellent cartoonist, and he produced some splendid cartoons to “wind-up” the GPO during these demos.

In 1966, for the hell of it, and because the frenzied activity of the 62 – 65 years had eased off a bit, I built a 3 vidicon colour camera (CQ-TV 58, 60), shown at the 1966 Convention, and subsequently used at Teddington on an advertisers demonstration when the Marconi MkVII would not work. The early ones were a bit like that!

Room in my lab at home was a bit cramped, and the first production COXBOX colour synthesiser was assembled on top of the colour camera. If my memory is correct, it was

installed in ATV’s first colour OB vehicle at Elstree, along with 3 PC60 cameras. Subsequent COXBOX units were sold to most ITV companies, usually for use with the station clock. In all, some 400 units of all the versions were made between 1967 and 1982.

These started to sell; for some reason, mainly in Germany, and with the imminent change in the ITV Programme Contracts (1968), it seemed a good time to see if I could cut it on my own.

Starting in the upstairs front bedroom of our new house in Twickenham, and with just me to begin with (and the cat!), product was made and delivered, and new products were being designed. Assembly and metal work was contracted out where possible.

Bob Warren from Thames (and an ex-Rediffusion colleague) joined me for a year, and then went back to Thames. 2 former

ABC colleagues replaced him, and we had to move out of my house to a small unit in Holly Road, Twickenham.

Over time, the company (Michael Cox Electronics Ltd) grew; we bought our own factory in Hanworth, and built up a good range of coding, switching and mixing products. By 1985, the company was employing 125 staff.

Carlton Communications bought it in that year. I found living with a public company pretty uncongenial, and Carlton and I parted after 3 months.

In the following year, I was asked to help financially with a Management Buy-Out from GEC-McMichael, and this company was set up as Vistek Electronics, to manufacture monitors, coders and standards converters. I became a major shareholder and non-executive director. I also set up Cox Associates Ltd at the same time. This produced Test Signal Generators, Title Assemblers and various other black boxes.

This story may help to explain why I did not have much time for BATC activities from around 1968 to 1998, apart from producing two children during that period.

Invited to join the IBC Management Committee in 1988, I became Deputy Chairman in 1991, and have been associated with it ever since, presently

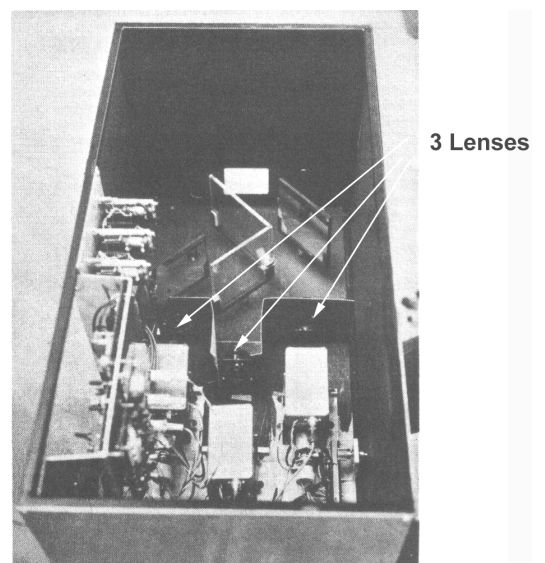

**COLOUR CAMERA SHOWING DICHROICS AND 3 YOKES/HEAD AMPS c. 1966**

as Vice President.

Now that I have relinquished my association with Vistek, I now have a little more time for interesting activities, often to add to the IBC Message Service facilities. My lab at home carries a fair selection of kit to help design, build and test video units, such as a "burned-in" stereo audio level indicator, and various units recently described in CQ-TV. It also carries a

few computers, the odd DV camera and a pair of Sony DV recorder-players.

One of the great advantages I have had is a supportive and patient wife. Sheila was a make-up artist at Rediffusion until just after the ITV contract change in 1968, when our daughter was born. She acted as Company Secretary and Director of our company until Michael Green got his hands on it in 1985. Her support and encouragement, and when

appropriate, warning has been of inestimable value over many years.

My hope is that the club will go from strength to strength during the next two years and beyond, and I will do all I can to help this along. I have noticed over the years the enormous improvement in CQ-TV. This reflects great credit on the editorial team. I am looking forward to my term of office.

## Circuit Notebook No. 72

By John Lawrence GW3JGA

### Oscilloscope Calibrator

Most professional oscilloscopes have an internal square-wave generator, the output from which is available on the front panel for testing purposes. The peak-to-peak (p-p) amplitude of this square-wave depends on the make of 'scope but is usually 1.0V or 0.5V. Some 'scopes have additional outputs of 100mV, 50mV and 10mV p-p.

The purpose of this signal is two-fold,

1. To check the sensitivity of the 'scope Y (vertical) input and any 'scope probe which may be connected.
2. To allow the 'scope probe H.F. compensation to be adjusted.

The frequency of the square-wave is usually around 1kHz. The frequency accuracy is not important as the square-wave is not intended for checking the calibration of the 'scope time base. What is more important is the actual p-p amplitude of the square-wave and its shape. It must be free from overshoot,

ringing or other aberrations but its rise-time does not have to be impressively fast, a microsecond or so is adequate.

For ATV purposes we frequently need to measure video signals that are supposedly 1V p-p. Unless we are well endowed, financially that is, we may rely on a popular run-of-the-mill 'scope of questionable accuracy, so a means of checking the 'scope's Y input sensitivity is important. Most 'scopes have a Y input switched attenuator and a variable gain control; by using both controls it is possible to adjust the Y input sensitivity so that 1V p-p agrees with the markings on the screen graticule. Once calibrated in this way the amplitude of a video signal being displayed can easily be measured.

### Square-wave Generator.

The circuit, shown in Fig.1, is powered by a PP3 9V battery and uses a 78L05 voltage regulator for the 5V supply. An alternative would be to use a resistor and a 5.1V Zener diode. The square-wave generator consists of a 555 Timer IC (U2) generating a square-wave signal of approximately 1 kHz, followed by a current switch formed by

D1 and the pnp transistor Q1.

When the output from U2 is low, current flow through RV1 and R3 is switched through D1 and is 'sunk' by the output of U2. Q1 is turned off and no current flows through R4 so the output is zero.

When the output from U2 is high, D1 disconnects and current flow through RV1 and R3 passes through Q1 to R4, the voltage drop across R4 being the signal output. The current flow may be set by adjusting RV1 to produce the correct p-p output voltage.

For setting-up purposes, disconnect D1 (or remove U2 if it is in a socket), connect a digital voltmeter (or other accurate meter having an input resistance of greater than 100k ohms) across R4, the output terminals, and adjust RV1 to provide 1.00 V DC. Reconnect D1 (replace U2) and the square-wave output will be 1.00 V p-p. This signal, when applied directly to the 'scope Y input will allow the sensitivity of one or more ranges to be checked.



Fig.2. 'Scope traces showing Under, Over, and Correct (level) of probe compensation

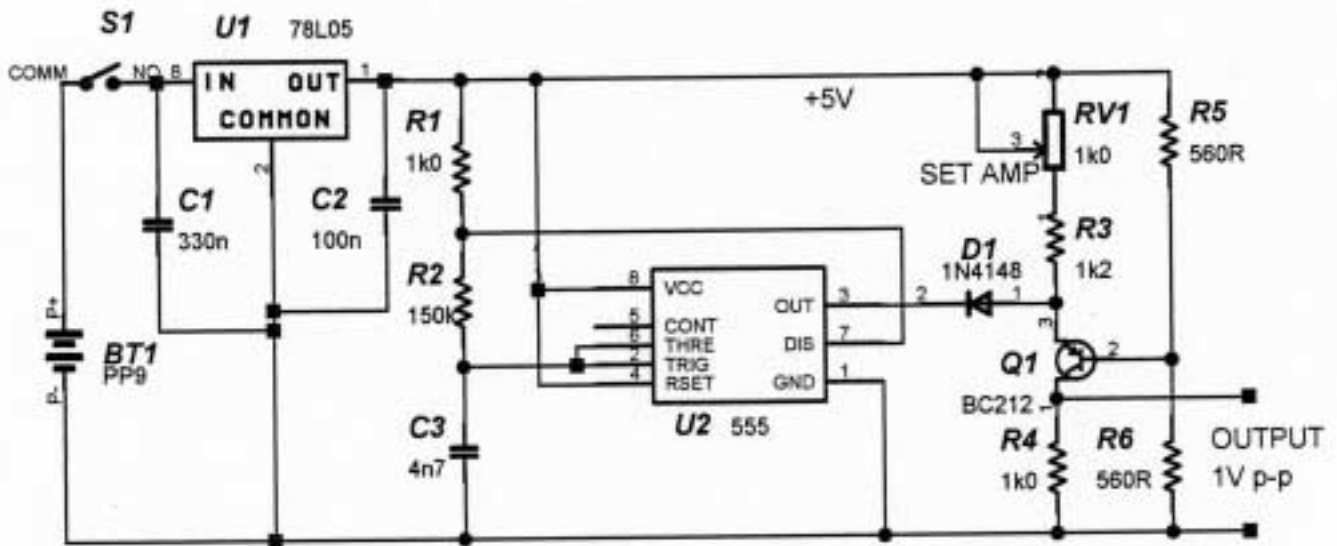

Fig.1. Oscilloscope Calibrator (circuit diagram)

### Oscilloscope Probes - setting H.F. compensation.

The Y input of most 'scopes has an input resistance of 1M ohm shunted by a capacitance of approximately 20 - 35 pF. The actual value is usually marked on the front panel. The capacitance is made up of internal circuit capacitance and strays. When a couple of metres of co-ax connecting cable is connected to the input, the cable capacitance can increase this value to over 150 pF, an amount which would affect the working of some circuits, to which it

may be connected.

The 'scope probe overcomes this problem to some extent by incorporating a resistance-capacitance attenuator, which, by a factor of 10, attenuates the signal, increases the input resistance and reduces the input capacitance, providing at the probe tip an input of 10M ohm shunted by about 13pF. To provide a 'flat' frequency response, the capacitance part of the probe attenuator is made adjustable to 'compensate' for 'scopes which may have a different input capacitance.

### Adjusting the 'scope probe 'compensation'

With the probe lead connected to the 'scope input and the probe tip connected to the calibrator output, set the 'scope time-base controls to display approximately 2 cycles of waveform across the screen and set the Y controls to give a suitable size of display. Check that the probe attenuation is correct as marked on the probe body - usually 10:1.

The H.F. compensation adjuster is usually a small screw (trimmer capacitor) either in the probe body or in a small box fitted to the BNC connector. The screw may be hidden by a dust cover. Monitor the displayed waveform whilst adjusting the probe compensation trimmer. The results of under, over and correct compensation are shown in Fig.2. The actual compensation setting is only valid for that particular probe - 'scope combination. If the probe is used with a different 'scope with a different internal input capacitance then the probe compensation will require re-adjustment.

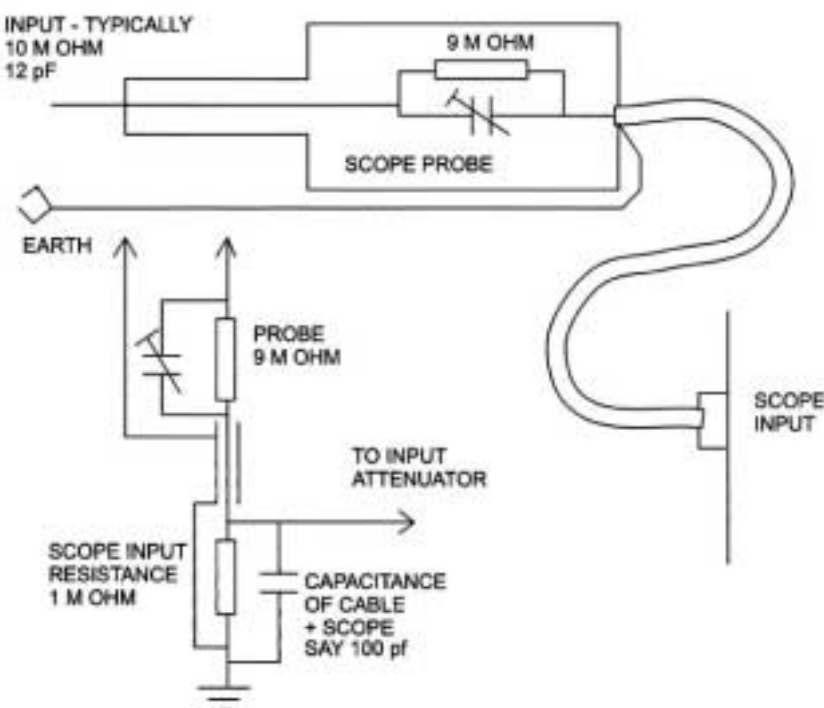

GW3JGA

### Reference.

Oscilloscope Probe Circuits. Joe Webber, Tektronix. Inc.1969, Beaverton, Oregon.



# G1MFG's ATV Modules Reviewed

By Brian Kelly

Anyone reading the last issue of CQ-TV or monitoring chat on the ATV frequencies will be aware of the "Cheapest ATV transmitters and receivers in Europe" claims of Giles Read, G1MFG. Of course transmitter kits and convertible satellite receivers for 23cm have been around for some time but Giles has also introduced 13cm units, a band that has lacked use because of the lack of ready-made equipment. Not only are modules for both bands now readily available but their prices are incredibly low; in fact with a pair of his boards it is possible to transmit and receive for under £90 per band. Giles recently loaned me a set of modules to "play" with so that I could assess their quality and usefulness to the ATV community. I have tested both the standard and "gold" version of the 23cm receiver to see how much improvement is made by applying all the documented modifications. The "gold" version is an already upgraded version of the standard module. The modifications are all described on the G1MFG web pages for those wanting to upgrade receivers themselves. My apologies that this review didn't make it in CQ-TV 191 but we (the Editor, Giles and myself) decided that the similarities in the 23cm and 13cm modules made it impractical to review them separately and by the time all the modules arrived, the print deadline had slipped by.

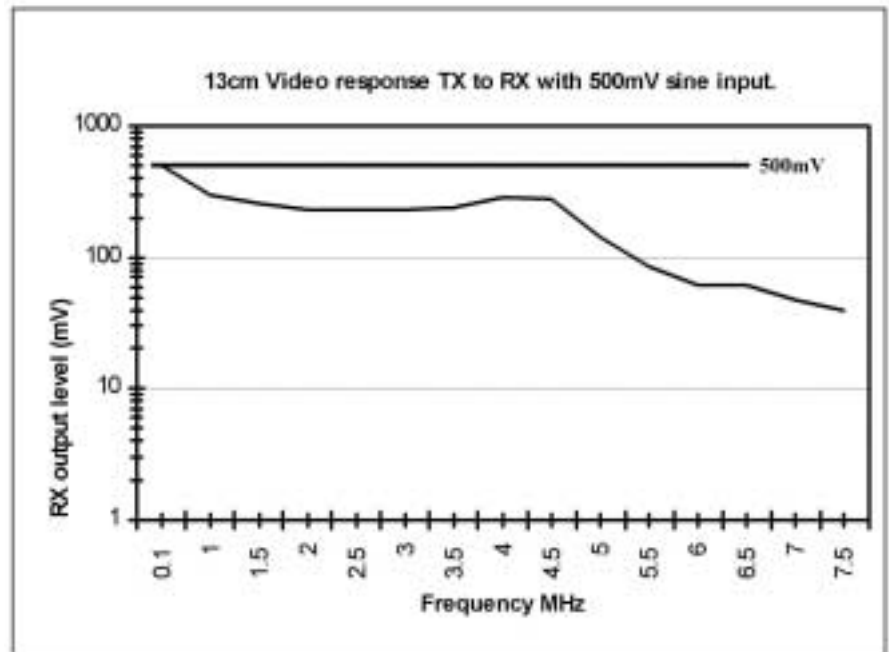

## First glance

The modules are very similar. The transmitter pair looks identical; the only differences are hidden inside the metal can. The receivers look to have almost identical circuitry but the PCB layouts are different and of course, the inner workings of the tinplate cans are different. Each module has five connectors. On the PCB are three PCB phono sockets for attaching the video, left and right sound channels and a 2.1mm DC power connector. On the metal can is an RF connector. The 13cm units use an SMA type while the 23cm ones are available with SMA or

"F" to order. Frequency selection on both transmitter modules and the 23cm receiver is achieved by setting an 8-way bank of switches. The 13cm receiver utilises a single push-button that cycles through 15 pre-set frequencies and a bank of four red LEDs to show which is currently selected. The last setting is remembered when power is removed. All the boards are low profile, the highest component being the can, which sets the overall height at about 20mm (3/4 in.) when measured from the bottom side of the PCB. The receiver board outline is approximately 60mm x 125mm (approx. 2.4 x 5 inches), the transmitter approximately 50mm x 160mm (approx. 2 x 6.3 inches). A single 2.5mm mounting hole is provided at the "socket" side of the board, the bush on the antenna connector can secure the opposite side. There is space on the PCB to drill additional mounting holes if needed.

## Transmitter RF Performance

Checks on spectral purity were carried out using the 23cm transmitter; unfortunately, my spectrum analyser top-ends at 2.1GHz so similar checks couldn't be done on the 13cm version. I am assured that the output is clean up to at least 10GHz.

Nothing that shouldn't have been there was seen and even mixing products from the two sound carriers were below

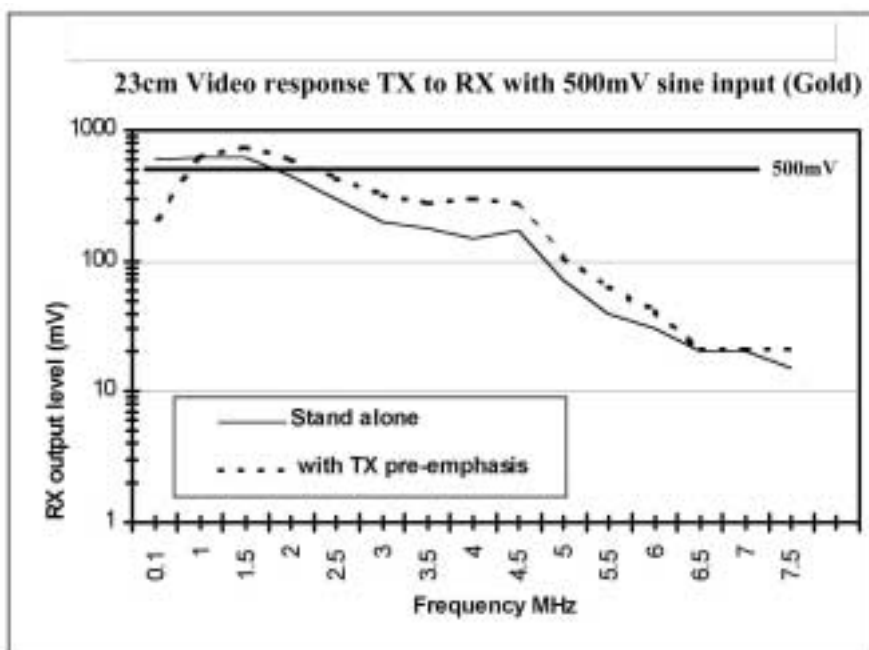



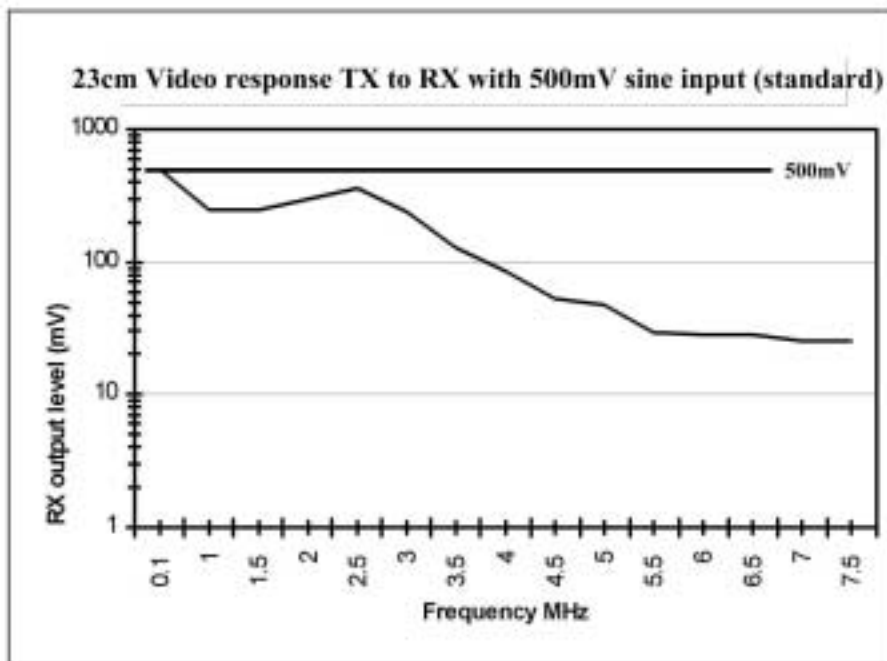

the noise floor of the analyser. The photographs show sweeps of the unmodulated transmitter output and the signal spread when fed with standard colour bars. Sweeping with a wideband receiver, although not able to take measurements, did not reveal any unexpected emissions. The carrier frequency was quite stable and drift was more than acceptably low. With the synthesiser set to 1316 MHz the frequency was measured at 1315.990 MHz when cold and 1315.979 after an hours operation. The sound sub-carriers were measured at 6.005MHz and 6.506MHz on both transmitters. A modification, to be posted on Giles' web site will explain how to disable the 6.5MHz one; alternatively, with care it can be re-tuned to a lower frequency.

### Receiver RF performance

Based on "off-air" tests, both receivers were exceptionally sensitive. The 23cm receiver easily beat my normal receive system, even with its pre-amp attached. Efforts to attenuate the 13cm receiver input to make it appear deaf, failed to stop it picking up a signal generator across my workbench. A weakness in both receivers was direct IF breakthrough. With an antenna directly attached, both picked up severe interference from UHF domestic TV transmissions. Admittedly, my QTH is 650 feet ASL and line of sight to two main regional transmitters! Sweeping a signal generator across the IF frequency (480MHz) also revealed a window of about 30MHz where leakage through the input socket

managed to reach the demodulator. In normal use, a filter or tuned pre-amp in line with the antenna would eliminate this problem. I understand a simple modification reduces susceptibility to direct breakthrough.

### Audio tests

With audio fed into the transmitter and monitored through the matching receiver, no obvious distortion was observed. Feeding a signal into only one channel and monitoring for breakthrough into the other showed that isolation was very good. The overall audio quality was more than acceptable. Whether having two channels is of any use for ATV applications is debatable but they are there anyway. The line level inputs at the transmitter returned almost the same levels at the receiver output socket. For use with a microphone, it would be necessary to boost the audio level before feeding it to the transmitter, however it matches well to the output level of most camcorders. There is no separate adjustment for audio deviation in the transmitter or gain at the receiver; this can easily be added in-line with the audio feeds if they are needed.

### Video tests

This is where the performance limitations and the differences between standard and "gold" receivers really came to light. To be fair, for the price, their performance is good and Giles is actively developing ways to make them

better. Most of the improvements are already implemented on "gold" units. All the modules are derived from origins in the remote video link market where a higher modulation index is used than is normal for ATV. Most of the problems stem from using lower deviation than they were intended for. A level control on the PCB allows the video signal to be reduced to normal levels. The control does not change the sound sub-carrier levels, which are approximately -30dBc, measured with no modulation applied.

Advancing the receiver gain control beyond its optimum setting results in quite bad video distortion with the picture looking very odd, in fact almost negative. On the standard units the control is already near top position but changes made on the "gold" 23cm receiver make the adjustment far smoother.

The overall video frequency response through the 13cm pair was quite good and more than acceptable for ATV use. The standard 23cm pair however, exhibited a rather poor HF response with received pictures looking noticeably smeary; I imagine that running the video amplifier at nearly maximum gain is limiting its bandwidth. Most of the modifications made on the "gold" units are for raising the HF end of the baseband spectrum and indeed the "gold" pictures were dramatically improved. In fact with the recommended TX pre-emphasis applied there was slight ringing on sharp contrast edges, this shows in the photograph where overshoot can be seen on the rising edge of the colour bars. There is some degree of tilt on low frequency video signals, partially from the TX PLL circuit and partly from the receivers coupling components. In practice this isn't likely to cause a problem on the air.

Communication with other users of these modules has confirmed my findings about the frequency response problems. The diagrams show the overall response of the 13cm, standard 23cm and "gold" 23cm modules respectively. The top trace is the signal fed into the transmitter and the bottom trace shows the receiver output terminated by a 75-ohm resistor. The video frequency response graphs demonstrate the HF roll off and how it is much improved on the "gold"

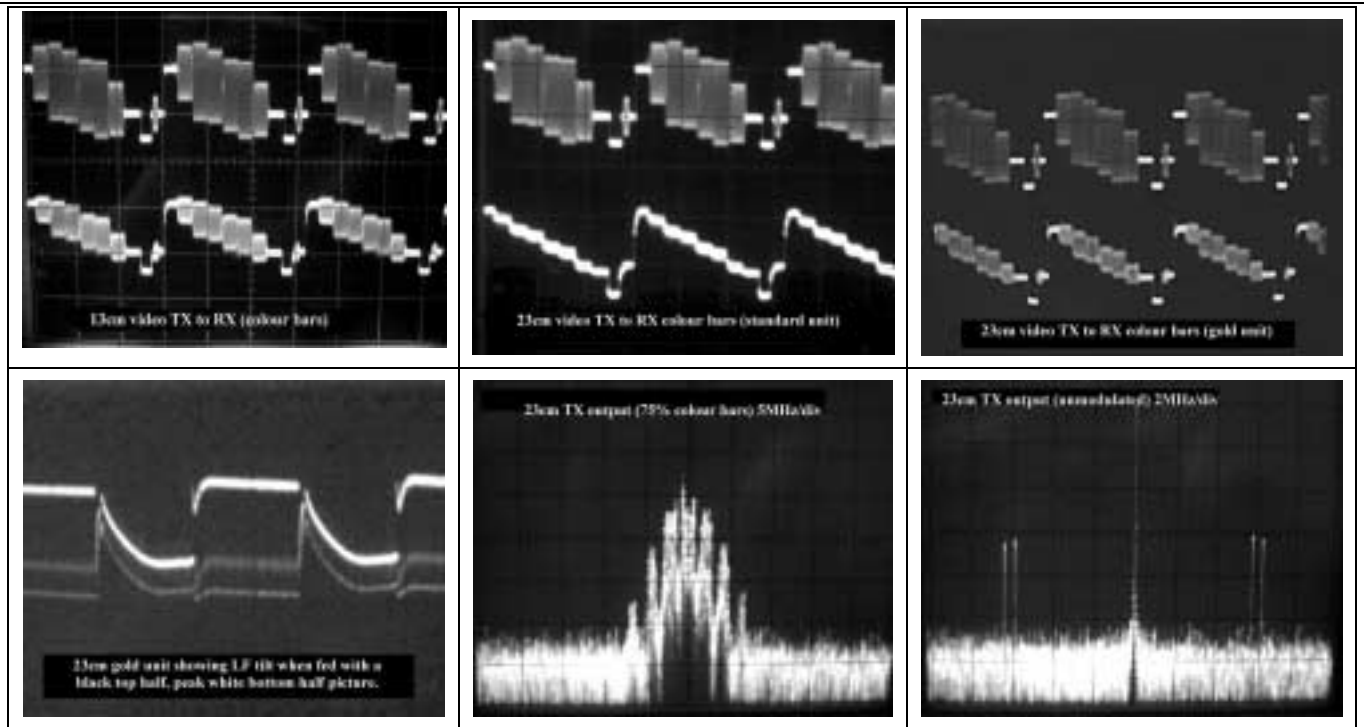

modules. Note that the line showing the effect of TX pre-emphasis has been shifted to take into account the 6dB attenuation the network incurred and then normalised at 1MHz.

One potential problem revealed by the response tests was that the sound carriers were present in the video output. The units do not appear to have any subcarrier traps installed. In normal use this would not be a problem and the addition of a de-emphasis network would almost eliminate the breakthrough.

**Power requirements**

The units all run from DC supplies between 12V and 15V, on-board regulators ensure that the circuitry sees a constant voltage. The regulator on the TX modules is rated for 12V output; it

will therefore work best with a higher input voltage than this. Current consumption for the 13cms modules was 120mA for the transmitter and 160mA for the receiver. The 23cm transmitter drew 130mA and the receiver 300mA. The higher current demand of the 23cm receiver is, I am told, because of a different on-board regulator design. All measurements were taken with a 13.8V supply with the units at working temperature.

**Conclusion**

For the home or portable ATV operator, these units present exceptional value for money. They are not up to BBC broadcast quality, but you would need to spend significantly more to achieve the same results elsewhere. I would seriously recommend users of the 23cm receivers

to apply all the known modifications and for potential new purchasers to consider buying the already modified “gold” version. The modifications do require a steady hand as tiny surface mount components are used on all the modules. Giles is actively improving their performance all the time and reports on his experiments are posted on his web site, <http://www.G1MFG.com> along with a wealth of other ATV items. As an almost “turnkey” method of getting on the air, they are undoubtedly a simple and cost effective way forward. Would I buy them? Based on my findings while testing the modules, I have already placed an order!

Giles can be contacted by email at: [giles@G1MFG.com](mailto:giles@G1MFG.com)

**Members only!**

As mentioned in a previous issue (CQ-TV 188, page 42) we have set-up a ‘members only’ section on our web site.

Access to these pages requires a username and password. This quarters codes are as follows: -

**Username:** amember

**Password:** brown

Giles, G1MFG has recently acquired a CEL Electronics P147-20 digital frame store synchroniser + pixel effects unit, and associated P151 digital effects controller. Some of it seems to work (it genlocks OK) but he hasn't got any information on how to drive it. Also, the P147-20 freezes when the second (of two) control cables are plugged in from the P151. He's already contacted Snell and Wilcox (who took over CEL Electronics) but they have been unable to offer much in the way of help on such an old piece of kit. Any assistance such as copies of manuals, reminiscences or general driving instructions would be most gratefully received. Giles can be contacted on 01489 860 318, by email at [giles@g1mfg.com](mailto:giles@g1mfg.com) or by post at L'Eglise, Durley Street, Durley, Southampton SO32 2AA.

# Home Video

By Barrie Blake-Coleman

## The true story of a British "first" in home video recording.

Britain stands pre-eminent in creative science and engineering but the depressingly long list of "lost" British firsts in invention shows how often thwarted or disillusioned British inventors and innovators have either abandoned their ideas or gone abroad, thereby reducing British competitiveness. Decades of British under investment in British ideas and British technologies has meant that other nations either independently develop the same ideas, or directly capitalise on British technical creativity - and soon overtake us in our markets. Just such a story is that of Norman Rutherford and his partner Michael Turner, who has learnt this lesson and are quick to remind us. They should know, back in the early 1960's they not only developed the first domestic video record and replay system, but also the first combined TV and VTR and the first Camcorder; but, it is claimed, poor foresight by their backers and investors lost them the edge.

## Making a Picture

The announcement of the *Cathodeon* Vidicon 3-inch TV camera tube early in 1960 took the attention of both Norman Turner and Michael Rutherford. The possibility of a new product for their Nottingham Electronic Valve Company (N.E.V.Co) was compelling. They wanted to develop a small CCTV system, but the broadcast standard camera tubes were far too bulky and expensive.

The *Cathodeon* device now made matters simpler. Cost was still a problem so, not requiring the full TV standard quality, they negotiated with Cathodian to buy all the slightly imperfect tubes (one or two drop-outs on the video array).

Oftimes a genius in circuit design, Michael developed the camera electronics using just four stages from two thermionic valves. This miracle of economy was based

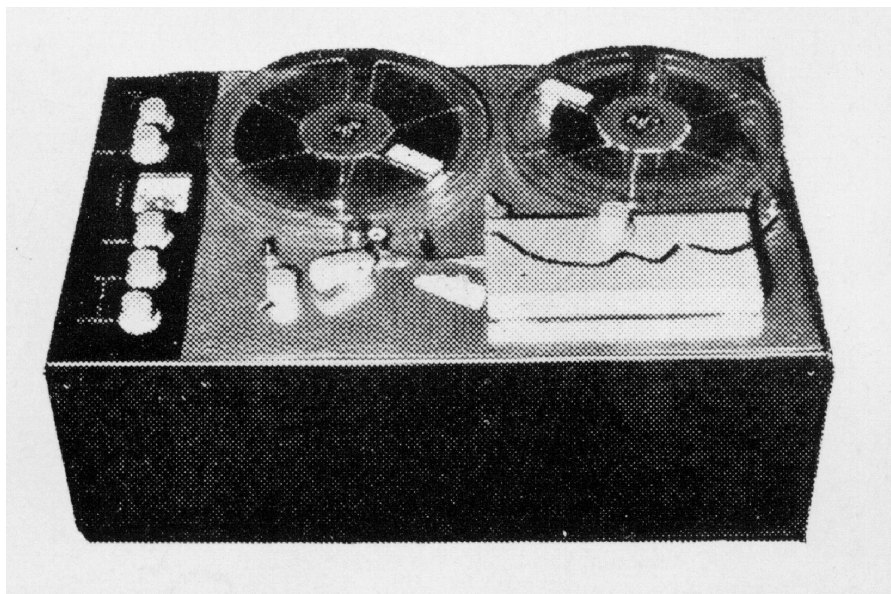

on an ECC82 double triode and an ECL82 triode pentode valve. The first provided a video amplifier and diode mixer, the second a triode r.f. oscillator and power output stage for the horizontal scan coils.

The vertical signal was obtained from a mains ripple supply, giving a usable mains locked sawtooth. "It was a unique - if not eccentric - piece of design typical of Michael and myself, but it worked like an absolute dream," so commented Norman Rutherford recently.

The whole camera assembly, designated *NEV1 Mini-Eye* in its initial design, sold for £150 and outpericed and outperformed anything around. It was £250 less than its nearest competitor, but the "transistorised" version soon appeared from their development bench and at £72 was even more astonishing.

Advertisements elicited an inspiring response. Domestic and international sales rocketed - an order for 4000 cameras came in from Germany. An absolute triumph given that the Germans held the British electronics industry in low regard.

"There is a popular point of view, originated by Emerson, which assumes that building the first, or a better mousetrap, results in people beating a path to your door - this must be the most pernicious fallacy ever to misrepresent invention."

## Take Over

The then senior engineer at Granada TV, Reg Hammons, saw a trade advert for the *NEV2* and thought the camera would be good for mobile outside broadcasts and rehearsals. He mentioned his viewing of the camera to Sidney (later Lord) Bernstein then head of Granada. Bernstein flew to Nottingham and at a meeting with both Norman and Michael learnt that not only was manufacturing capacity very limited, but the development of the camera had so depleted the company's reserves that they were unable to meet anything approaching a substantial order. He then asked how much they would need to continue R&D and production. "Too much." said Norman "About half the value of the Company".

"What is that amount" asked Bernstein. "About £20,000" said Norman. "That's petty cash" Bernstein said and instructed his accountant to write a cheque there and then. The company now had a new owner, but though Bernstein had a 75 per cent stake, both the original partners were appointed directors with full management of the company's operations. All debts were paid off. More to the point they now had no limits to what they could spend on R&D.

## In a Spin

Reg Hammons made frequent trips from Granada to liaise with the company on behalf of

Bernstein. On one occasion he mentioned that he was aware of a large effort taking place in the USA and Japan to develop a video system for recording broadcast TV at home. In the USA, in the middle fifties, Ampex had developed a broadcast system using 2in tape, with a vacuum arrangement to hold the tape around the 4-head drum, and a similar approach was being tried for domestic recorders.

Hammons thought there could be a large market for home video recorders and urged the two to have a go at developing a system for the British market. The idea found a receptive audience; the mini-eye camera had sold well but now orders were tailing off.

It was known that Ampex had solved the videotape problem using four rotating heads - but this was an expensive option for a home video system. At first NEV tried a narrow bandwidth design based on a domestic audio recorder to emulate the high-speed wire and metal tape recorders already used by the big broadcasting operations.

It was the path of least resistance - no one actually knew what the maximum frequency limit was on very high-speed recording and so they converted two ¼ in. reel-to-reel Grundig and Ferrograph AF recorders to run at 60 and 120 inches per second (ips). Surprisingly, enough video information could be recorded at 60 ips to create a shadow of a picture; at 120 ips it was "just recognisable" but a lot more work needed to be done.

But months of work gave little in the way of encouragement. Then, in January of 1962, Michael Turner discovered in the course of examining head driver methods that a considerable improvement in signal-to-noise could be achieved by introducing significant pre-emphasis on the driver signal.

The improvement was so profound that it implied that a broadcast quality picture could be achieved quite soon.



**Telcan unit playback demonstration at its launch in 1963. The early prototype (1962) model is shown in the heading.**

Unfortunately it was also a damaging revelation - the improvement was genuine but simply took the existing operational limits in a different direction

## Head to Head

The main problem was identified as the record and replay heads. The head gap was too wide to give the high frequency response necessary to approach the ideal 3MHz needed to reproduce the full video bandwidth of the 405-line system. It was also determined that the lowest response able to give a wide enough grey scale to enable the picture to have clarity was 2.5MHz.

Something needed to be done to eliminate the head problem and give the designers a chance to grapple with the other aspects of the video processing. A narrow gap head was produced from an existing Ferrograph unit but even without a.c. bias on the tape (rather, a heavy d.c. bias directly applied to the tape by means of a permanent magnet) and heavy pre-emphasis on the video signal, the best that could be achieved was 2MHz. "It just got by" Norman Rutherford recounted, but it had to be better.

Unfortunately they had a seemingly intractable problem. The narrower the head gap, the lower the magnetic path reluctance around the gap became. Thus, the greater the flux shunt around the gap, the more the signal field was shared between the gap and the leakage



**Close-up shot of the TV screen during Telcan replay.**

path.

The result was that as the response was increased with a narrowing gap, so the signal-to-noise ratio worsened. A mu-metal Ampex head (intended for h.f. telemetry and imported from the States) was one possible solution, but it was prohibitively expensive. The only recourse was to design one themselves!

Many months of work led inevitably to

course, still highly differentiated and this was equalised by employing a series of 3db/octave integrators and phase correction circuits to recover the original signal. Tape speed still needed to be high (120 ips for broadcast standard recording) but by using 12,000ft of ¼ in. triple play tape on 10½ in. spools (for increased play time and better head wrap) the record time was extended to up to 20 minutes. An added advantage was the narrow video and audio track widths (the latter f.m.

expected further investment. The reason given at the time was poor picture quality, but this was specious and clearly not the issue.

Whatever the reason, Norman Rutherford and Michael Turner had lost a major investor and somehow had to keep the business going. The Granada decision could not have come at a worse time, the tube reconditioning business had virtually collapsed with the ever-improving quality and durability of new tubes, and the company payroll was now supporting some 70 plus people. That Bernstein allowed the directors of NEV to buy back his interest for the original buying price was no consolation.

Initially thinking themselves fortunate, they were quick to find a new partner with the USA based Cinerama Corporation, which had made its shareholders a massive return with the film "*How the West Was Won*". Cinerama bought in to N.E.V.Co to the value of £200,000, even though at this time Cinerama were, as an organisation, running at a substantial loss.

### Well Kitted Out

Time had been lost, and though not personally financially embarrassed by the new US shareholding, the two partners were aware of their financial and business vulnerability - they were on their own once again and looking to develop their products and product range further. Hoping to salvage the profitable divisions of the company Norman, as Managing Director, split the operation by forming Telcan (Research and Development) and Telcan TV, the latter being mainly involved in manufacturing.

Trading again in early 1963, the partners (now including a financial manager, Brian North) set out to provide the video units in kit form (as the *Telcan TKR 500*). The new operation manufactured every major component necessary including the record/replay heads, printed circuit boards, video circuits, tape transport and a variable capstan size system (¼ h.p. motor). With variable speed operation (60, 120 or 180 inches per second) the kit, if correctly assembled, produced a recorder of very satisfactory performance.

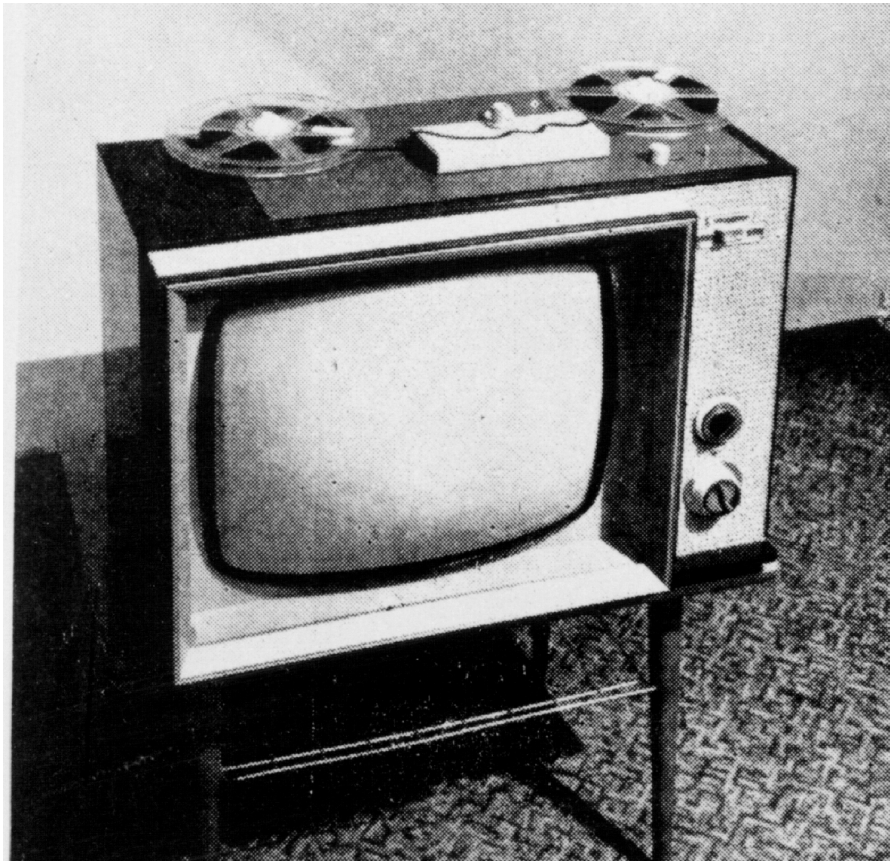

The "Combi" television/video recorder

a design which avoided the conventional problems associated with ordinary heads - they plumped for a cross-field head where the passive section was made of two screw adjustable copper arms nominally separated at the rear by a 200 micron gap with a tape face gap of just under 50 micron. The active section carrying the coil laterally straddled the two copper arms and this design gave the necessary bandwidth.

Nevertheless, DC bias was still employed as too a considerable amount of pre-emphasis. But by contriving an over-wind on the final video driver stage's inductive load, the effective bandwidth shot up to well in excess of 2.6MHz.. The replay signal was, of

modulated on a second head), this narrow track enabled the tape to be turned over and recorded on the other side. More to the point, the replay produced a very good video signal - normally (with high contrast pictures) hard to distinguish from the original 405 transmission even at lower speeds. Head fouling remained a problem with the relatively high oxide loss of early tapes, but the passive section of the head was designed to be quickly removable and cleaned.

### On Their Own Again

Demonstrations to Granada were unexpectedly cool, for reasons never fully explained by Bernstein. N.E.V.Co lost their sponsor at the very time it



A public demonstration and press conference at the Aldwych Hotel, London, held on June 24th 1963 created

“Combi” examples fitted into TV’s, but of the total number sold the greater

modern floppy disk drive. A fair number were produced and for a short while were popular.

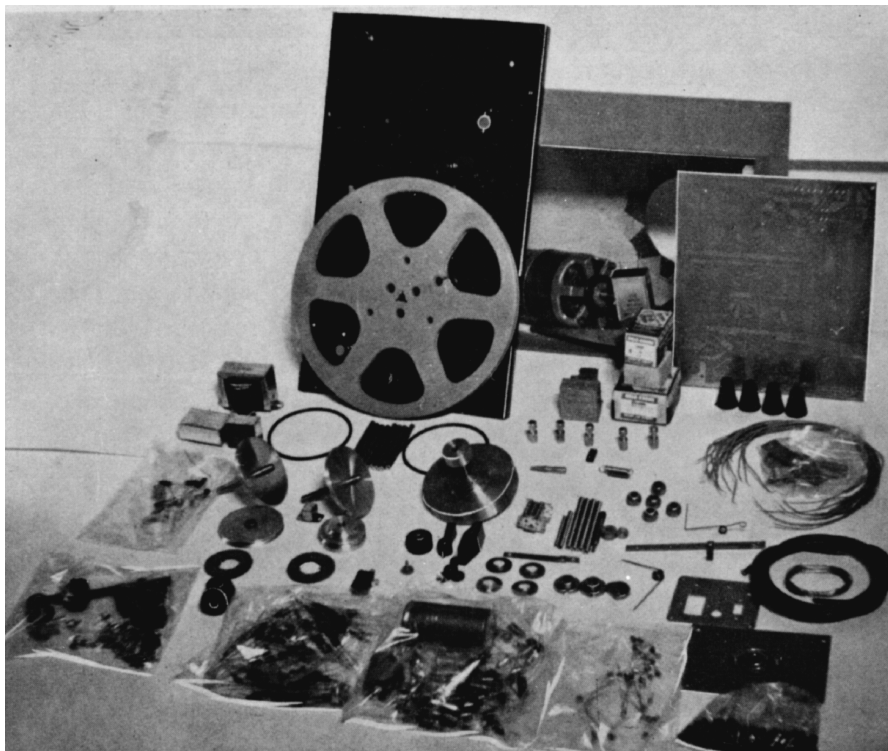

**The Wesgrove (Telcan) kit of components (1963)**

a wealth of interest and publicity, but the attitude of the press and the public appeared to be diffident. It was staggering that few could actually see the need for “home video recording” - even if they had the slightest notion of how technically awesome the development of Telcan was!

Norman Rutherford demonstrated Telcan on the BBC 9 O’clock News (replaying the opening few minutes of the broadcast) but this was as ineffective as a next day ATV interview was ridiculous - the interviewer continually asking the originators if they thought Telcan a “gimmick”. They were later to maintain that the interviewer could not grasp the concept of electronic recording, and mistakenly believed that the Telcan method involved the use of an 8mm movie camera (similar to a system already in use).

Orders for the Telcan units were slow. The kits sold for £60 (some £700 today) - only the technically skilled and well off could afford them. A number of pre-built units did sell well, as too did special

majority were kits.

As sales of the TKR 500 faltered, the partners designed a miniature battery driven portable record player for 7 inch 45 r.p.m. records which, entirely self contained and enclosed, operated like a

### Orders from Overseas

However, Cinerama, already a stock holder in N.E.V. Co, proposed through its Chairman, Nicholas Riesini, the formation of a joint company for exploitation of Telcan in the US and, given the other possible financial holdings of stock in N.E.V. Co, agreed to purchase any stock willing to be released by other interests. This ultimately resulted in a fairly large injection of new cash for the company and R&D was the first to benefit. For a moment there appeared to be yet another new beginning for the company.

Unfortunately, what was desirable in one context was not in another and the two partners found themselves embroiled in business negotiations and legal entanglements to the detriment of the company’s main business. In December of 1963 Norman and Michael were asked to demonstrate the videorecorder at a crucial shareholders meeting of the ailing Cinerama Corporation at the Capital Theatre, Broadway in New York.

However, they were asked to try something novel - to video the shareholders themselves at the meeting.



**One of the last remaining examples of the Telcan video recorders on show at the Wollaton Hall Industrial Museum, Nottingham**

Being away from base, and unable to get one of their own *Mini-Eye* 4 inch cameras, Norman got hold of a 525-line studio standard Vidicon camera and videoed all and sundry, amazing everyone by playing back the pictures at the meeting.

The technology was enough to placate all the unhappy shareholders – now absolutely convinced that Cinerama had a real winner. However, all was not sweetness and light; Cinerama itself was not actually able to invest any further – even though its individual principals were well able to. The partners returned from the US with the mistaken expectation of a large order for the new “*Telcan*” system but it failed to materialise. As Cinerama floundered the Chairmanship changed to that of William Foreman, a creditor of Cinerama. Foreman was not slow to convey his personal distrust of the *Telcan* business to the new Executive. Sensing mounting hostility from their new principals, the two partners decided to look further afield for investment and gave demonstrations in the US to the Filco (Ford Motor Co.) and Admiral Corporations. But the interest and enthusiasm was less than it might have been in the face of an ever growing hostility and starvation of funds.

In hindsight, Norman Rutherford admits that had they “toadied” a little to their new partners, things may have gone better. In short, there was only one way out and in August of 1964 Norman Rutherford, as Managing Director, put the company into voluntary liquidation.

**Overstretched**

Undaunted, and with the greater number of their 70 odd original staff still at hand, the two partners set up again at Basford under the name Wesgrove. Again this was a kit

**TV RECORDING AT HOME ON £62 UNIT**

**BRITISH EQUIPMENT DEMONSTRATED**

FROM OUR SPECIAL CORRESPONDENT  
A considerable British achievement in the development of

**U.S. contract for Telcan units**

THE East Bridgeford electronics firm which invented the revolutionary unit for recording TV programmes at home, have secured a contract for the manufacture of 100,000 sets a year in America by 1966.

Mr. Norman Rutherford, 29, and Mr. Michael Turner, 32, are the technical experts and Mr. Brian North (28) and Mr. Jack Jones (42).

Mr. Rutherford and Mr. Turner are the technical experts and Mr. North and Mr. Jones have looked after the financial and commercial aspects.

Capacity  
Last night, Mr. Rutherford said: “Telcan will not be manufactured at East Bridgeford because it is beyond the demand for the device.”

Maximum lead  
“We shall have to work hard to get the maximum lead we can expect before other manufacturers catch up.”

Exciting service  
The other Telcan TV programmes will be produced in a conjunction with the American manufacturer.

On the main drawback to the Telcan set—the short running time of 15 minutes—Mr. Rutherford said: “The demand in this country for 100,000 would not justify setting up a factory.”

Mr. Rutherford and the other Telcan TV programmes will be produced in a conjunction with the American manufacturer.

On the main drawback to the Telcan set—the short running time of 15 minutes—Mr. Rutherford said: “The demand in this country for 100,000 would not justify setting up a factory.”

Mr. Rutherford and the other Telcan TV programmes will be produced in a conjunction with the American manufacturer.

On the main drawback to the Telcan set—the short running time of 15 minutes—Mr. Rutherford said: “The demand in this country for 100,000 would not justify setting up a factory.”

Mr. Rutherford and the other Telcan TV programmes will be produced in a conjunction with the American manufacturer.

On the main drawback to the Telcan set—the short running time of 15 minutes—Mr. Rutherford said: “The demand in this country for 100,000 would not justify setting up a factory.”

Mr. Rutherford and the other Telcan TV programmes will be produced in a conjunction with the American manufacturer.

On the main drawback to the Telcan set—the short running time of 15 minutes—Mr. Rutherford said: “The demand in this country for 100,000 would not justify setting up a factory.”

Mr. Rutherford and the other Telcan TV programmes will be produced in a conjunction with the American manufacturer.

On the main drawback to the Telcan set—the short running time of 15 minutes—Mr. Rutherford said: “The demand in this country for 100,000 would not justify setting up a factory.”

Mr. Rutherford and the other Telcan TV programmes will be produced in a conjunction with the American manufacturer.

On the main drawback to the Telcan set—the short running time of 15 minutes—Mr. Rutherford said: “The demand in this country for 100,000 would not justify setting up a factory.”

Mr. Rutherford and the other Telcan TV programmes will be produced in a conjunction with the American manufacturer.

On the main drawback to the Telcan set—the short running time of 15 minutes—Mr. Rutherford said: “The demand in this country for 100,000 would not justify setting up a factory.”

**Now it's taped TV for the home**

By Our London Correspondent

A NOTTINGHAMSHIRE invention which will put recorded TV programmes in sound and vision on standard audio tape at low cost was demonstrated in London yesterday.

Called “*Telcan*,” it has been developed by the Nottingham Electronic Valve Company, at East Bridgeford, during the past two years—and the premises are already too small to cope with the expected demands.

It is the joint effort of a team of young experts—Mr. Norman Rutherford (30), Mr. Michael Turner (29), Mr. Brian North (28), and Mr. Jack Jones (42).

Mr. Rutherford and Mr. Turner are the technical experts and Mr. North and Mr. Jones have looked after the financial and commercial aspects.

Capacity  
Last night, Mr. Rutherford said: “Telcan will not be manufactured at East Bridgeford because it is beyond the demand for the device.”

Maximum lead  
“We shall have to work hard to get the maximum lead we can expect before other manufacturers catch up.”

Exciting service  
The other Telcan TV programmes will be produced in a conjunction with the American manufacturer.

On the main drawback to the Telcan set—the short running time of 15 minutes—Mr. Rutherford said: “The demand in this country for 100,000 would not justify setting up a factory.”

Mr. Rutherford and the other Telcan TV programmes will be produced in a conjunction with the American manufacturer.

On the main drawback to the Telcan set—the short running time of 15 minutes—Mr. Rutherford said: “The demand in this country for 100,000 would not justify setting up a factory.”

Mr. Rutherford and the other Telcan TV programmes will be produced in a conjunction with the American manufacturer.

On the main drawback to the Telcan set—the short running time of 15 minutes—Mr. Rutherford said: “The demand in this country for 100,000 would not justify setting up a factory.”

Mr. Rutherford and the other Telcan TV programmes will be produced in a conjunction with the American manufacturer.

On the main drawback to the Telcan set—the short running time of 15 minutes—Mr. Rutherford said: “The demand in this country for 100,000 would not justify setting up a factory.”

Mr. Rutherford and the other Telcan TV programmes will be produced in a conjunction with the American manufacturer.

On the main drawback to the Telcan set—the short running time of 15 minutes—Mr. Rutherford said: “The demand in this country for 100,000 would not justify setting up a factory.”

Mr. Rutherford and the other Telcan TV programmes will be produced in a conjunction with the American manufacturer.

On the main drawback to the Telcan set—the short running time of 15 minutes—Mr. Rutherford said: “The demand in this country for 100,000 would not justify setting up a factory.”

Mr. Rutherford and the other Telcan TV programmes will be produced in a conjunction with the American manufacturer.

On the main drawback to the Telcan set—the short running time of 15 minutes—Mr. Rutherford said: “The demand in this country for 100,000 would not justify setting up a factory.”

Mr. Rutherford and the other Telcan TV programmes will be produced in a conjunction with the American manufacturer.

On the main drawback to the Telcan set—the short running time of 15 minutes—Mr. Rutherford said: “The demand in this country for 100,000 would not justify setting up a factory.”

Mr. Rutherford and the other Telcan TV programmes will be produced in a conjunction with the American manufacturer.

On the main drawback to the Telcan set—the short running time of 15 minutes—Mr. Rutherford said: “The demand in this country for 100,000 would not justify setting up a factory.”

Mr. Rutherford and the other Telcan TV programmes will be produced in a conjunction with the American manufacturer.

On the main drawback to the Telcan set—the short running time of 15 minutes—Mr. Rutherford said: “The demand in this country for 100,000 would not justify setting up a factory.”

form recorder business though, as always, customers could purchase a fully assembled version.

Unfortunately, by this time, the Ampex helical scan system had already appeared in competing domestic video recorders. One leader was the Sony 1/2 in. reel-to-reel video recorder; Philips were also competing while a further system was marketed by Loewe Opta in Germany.

The message was obvious, the *Telcan* linear system needed to be updated to record in the helical scan mode in order to rival other products. But this was beyond the resource of the already ailing and overstretched *Telcan/Wesgrove* operation. Talks with various potential backers, even Japanese interests, got nowhere. The *Wesgrove* business, like its predecessor, was put into voluntary liquidation just 19 months after the

**FAILS TO RAISE FINANCE FOR SALE OF TV INVENTION**

THE Nottingham Electronic Valve Co. which pioneered in the field of colour and video-recording television equipment, is to go into voluntary liquidation.

This was announced yesterday, only a few months after the East Bridgeford firm said they had obtained a big American contract for their Telcan television tape-recording device.

Mr. Norman Rutherford, 29, and Mr. Michael Turner, 32, are the technical experts and Mr. Brian North (28) and Mr. Jack Jones (42) are the financial and commercial aspects.

Capacity  
Last night, Mr. Rutherford said: “Telcan will not be manufactured at East Bridgeford because it is beyond the demand for the device.”

Maximum lead  
“We shall have to work hard to get the maximum lead we can expect before other manufacturers catch up.”

Exciting service  
The other Telcan TV programmes will be produced in a conjunction with the American manufacturer.

On the main drawback to the Telcan set—the short running time of 15 minutes—Mr. Rutherford said: “The demand in this country for 100,000 would not justify setting up a factory.”

Mr. Rutherford and the other Telcan TV programmes will be produced in a conjunction with the American manufacturer.

On the main drawback to the Telcan set—the short running time of 15 minutes—Mr. Rutherford said: “The demand in this country for 100,000 would not justify setting up a factory.”

Mr. Rutherford and the other Telcan TV programmes will be produced in a conjunction with the American manufacturer.

On the main drawback to the Telcan set—the short running time of 15 minutes—Mr. Rutherford said: “The demand in this country for 100,000 would not justify setting up a factory.”

Mr. Rutherford and the other Telcan TV programmes will be produced in a conjunction with the American manufacturer.

On the main drawback to the Telcan set—the short running time of 15 minutes—Mr. Rutherford said: “The demand in this country for 100,000 would not justify setting up a factory.”

Mr. Rutherford and the other Telcan TV programmes will be produced in a conjunction with the American manufacturer.

On the main drawback to the Telcan set—the short running time of 15 minutes—Mr. Rutherford said: “The demand in this country for 100,000 would not justify setting up a factory.”

Mr. Rutherford and the other Telcan TV programmes will be produced in a conjunction with the American manufacturer.



Norman Rutherford (right) and Michael Turner (left) with their wives and a Telcan “Combi” set at the press launch, June 1963.

Cinerama debacle.

## Epilogue

Only two of the original Telcan units built by Norman Rutherford and his Company survive to this day - one in San Francisco, owned by Al Cox the owner of a music shop and FM radio station, and one now to be seen at the *Wollaton Hall Industrial Museum* in Nottingham. Norman and his partner Michael Turner became disaffected and parted company just after the firm was wound up. Norman continued to do some consultancy work in electronics; he eventually gave up and went into property development with his brother, only returning to his first love in the early 1980's when he became involved in developing an infrared transmission system for closed circuit TV. He finally found lasting fame by way of an entry into the *Guinness Book of Records* in 1982.

Much could be said about this lost opportunity for British enterprise in terms of too little too late, but the reality is different. The technical principle was only good enough to prove the value of the product - for all the negativity faced at the Telcan launch, everyone quickly came to see how useful a home video unit could be and that a massive market awaited.

Although the original technical principle of Telcan defined the operational limits, the linear record system was never going to have the technical flexibility required by the market (for convenient long play, high resolution monochrome or colour recording). Also, the short record/replay time, and poor long-term head dependability were very much a weakness. Yet, for all that the promise was there, and had the investment vision come anywhere close to the technical vision, then a good deal more might have been accomplished. As it was, the two partners, Norman Rutherford, Michael Turner and their associates did unequivocally demonstrate and sell the first commercial *home* video recorder, the

first Camcorder (and the first "Combi" TV and video recorder). What price "vision"?

## First Meeting

Norman Rutherford and Michael Turner were school friends in the war years, having met one Wednesday afternoon on the school football field during a sports period. They found themselves in trouble when the sportsmaster espied them rooted to the spot in mid-field; deeply engrossed in discussing a design for a radio control circuit - a small error for both, since Michael was on one side and Norman was the opposing goalie!

Norman's father owned a radio retailers and then, later in the fifties, a television retail and repairs shop in Nottingham. Michael's father was the proprietor of a garage, and thus both boys developed against a background of technology and engineering. Later, in 1952, the two boys met again as college chums at the People's College in Nottingham, where both developed an abiding interest in electronic design, becoming immersed in the white heat of the post war broadcasting and electronics age. They bought government surplus components and constructed the first television receiver in the East Midlands to operate from the London transmitters.

Norman Rutherford went on to study, at the (then) Nottingham and District Technical College, and lost contact with Michael for a few years until early 1957. Then, with a £100 stake scraped up and borrowed they started a partnership and the late fifties dawned with both men making a living reconditioning television Cathode Ray Tubes (CRT's).

They started in a converted garage with Norman, Michael and one employee learning the delicate art of cutting off tube necks, removing the electron guns and rejuvenating the cathodes. New TV tubes were notoriously unreliable (usually cathode poisoning due to poor vacuum or faulty assembly) and a replacement CRT cost in excess of £20

to purchase (equivalent to £230 today). However, the Nottingham partners were bringing the price of reconditioned CRT's down to 9 pounds and 10 shillings (£9.10s.0d) and in a good week could recycle well over 50 tubes through the process.

Not all CRT re-conditioning had been immediately within their grasp - Mullard tubes had removable cathodes, Mazda ones did not. But they soon solved the problem. A US company (Superior Electronics) began to sell complete electron gun assemblies. Buying the new guns gave them an even greater edge - they had developed all the machinery and process technology (including the r.f. induction heating and most of the vacuum technology) for a universal CRT re-gunning process.

Now they started to make more money selling and instructing on complete re-gunning systems (proudly made by their now well established and well respected Nottingham Electronic Valve Company). The old workshops, in a disused cinema at Netherfield, became hopelessly limited and the company, now with 12 employees and an accountant, moved to an old malt house at East Bridgford near Nottingham.

**Acknowledgements.** The author offers his sincere thanks to Mr Norman Rutherford (for patiently retelling his story for the umpteenth time), to Mr Rob Cox, curator of the *Wollaton Hall Industrial Museum* in Nottingham, Mr John Brunton at the *Nottingham Post* and to all those that gave their time to find, or process, material for this article.

**This is an updated version of an article that was first published in the April 2000 edition of *Everyday Practical Electronics*, and is reproduced here by kind permission of the editor.**

© 2000 by Everyday Practical Electronics. Their web site is at: - <http://www.epemag.wimborne.co.uk/>

"G1MFG, purveyor of Europe's cheapest synthesised ATV transmitters and receivers, is at it again. This time, he's turned his attention to LCD monitors, and offers a range of resolutions and sizes, starting at £120. He's also expanded his advertising onto the inside back cover. Look out for a review of the monitors on page xxx and of course Brian Kelly's review of the G1MFG 23cm and 13cm transmitters on page 9."



## Subscription rates

### By the Membership Secretary

The subscription rates to the BATC for the year 2000 are shown below. This is the first price rise in many years but, with the continuing rising costs of production, printing and postage, a price rise was inevitable.

However we hope you will agree that we have continued to improve the magazine with the change to the A4 format and use of colour within the magazine and agree with us when we say that this still represents excellent

value for money. I quote from the VHF/UHF column in The Radio Society of Great Britain's journal, "As ever, this 60 page magazine is one of the finest amateur publications you are likely to find".

Years	Surface	Airmail
One	£15.00	£21.00
Two	£29.00	£41.00
Three	£43.00	£61.00

Please note that the 'Surface' rate cover postage within the EEC.

We have also continued to improve our web site at [www.batc.org.uk](http://www.batc.org.uk) and this has proved to be very popular and is now attracting many new members.

If your subscription is due shortly you will find a renewal letter enclosed with this magazine.

You hope you will continue to support the Club and we look forward to receiving your renewal.

## CQ-TV Commercial advertising rates



Size	Mono	Colour
Quarter page	£20	£25
Half page	£40	£50
Full page	£80	£100

Discounts of 5% for 2-3 insertions and 10% for 4 and above apply to the above prices.

If you would like to advertise in CQ-TV, then please contact our advertising manager, Trevor Brown, 14 Stairfoot Close, Adel, Leeds, LS16 8JR. Tel: 01132 670115. Email: [adman@batc.org.uk](mailto:adman@batc.org.uk)



### Amateur Television Quarterly

Great articles on:  
ATV  
BALLOONING  
PROJECTS  
SSTV  
ATV ACTIVITIES

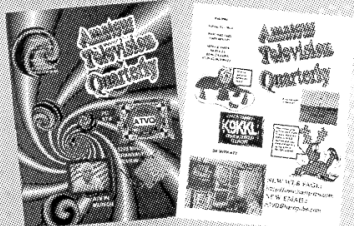

USA \$18 Year  
Canada \$20 Year  
DX \$26 Year  
(US Dollars)

### Do you have these books yet?

**ATV Secrets Vol 1** is a great book for the beginner. 64 pages of answers to your questions about starting in ATV! Only \$8.95 plus shipping.  
**ATV Secrets Vol 2** is 292 pages with 90 ATV Projects. Only \$24.95 US plus shipping.



Get BOTH for  
ONLY  
\$29.95 US  
plus shipping

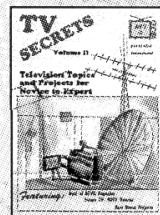

Write or check webpage TODAY for more information!  
Published by Harlan Technologies  
5931 Alma Dr., Rockford, Illinois 61108 USA  
<http://www.hampubs.com>

### OSCAR Satellite Report

A great NEWSLETTER published twice a month to keep you up to date on what is happening. Sent FIRST CLASS MAIL!

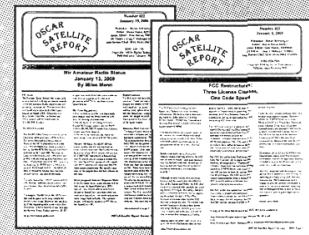

USA \$35 Year  
Canada \$38 Year  
DX \$46 Year  
(US Dollars)

---

## The Quest for Just That Little Bit More at 13cm

---

### Roger Jones G3YMK

The modules described in the article in CQ-TV 191 enable an easy route to getting going on 13cm ATV and the results are very pleasing. The receiver gives very good account of itself and, when used with a reasonable pre-amp, not much more can be done on this part of the link. The aerials used are vitally important. At this frequency dishes are practical and provide good gain. An old Astra dish with a folded dipole feed was tried and worked well. The wind loading is high, however, requiring fairly substantial support structures. Yagis and loop variants are much smaller and these can be home made with simple tools. A number of designs have appeared over the years but all tend to be quite narrow-band. This can lead to disappointing results for FM ATV.

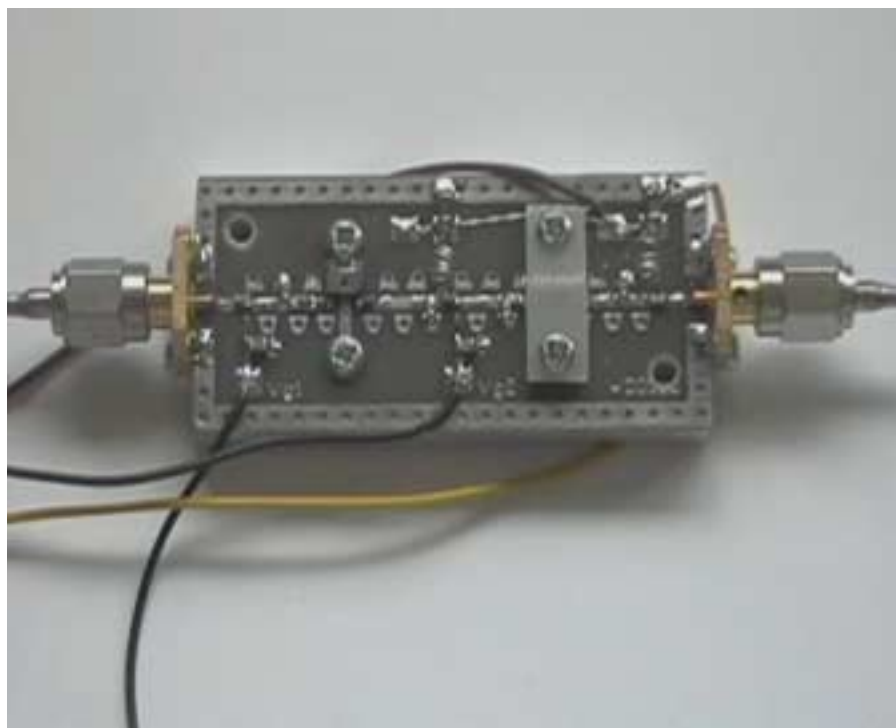

### Commercial Aerials

Commercial offerings are few; Tonna from France did offer a yagi but it seems at present difficult to obtain. It is probably only manufactured in batches, so with the launch of Oscar Phase 3 we might see examples back on the market.

### The G3WDG 1 watt 13cm PA available from RSGB Microwave Components

Directive Systems in the USA manufacture a loop yagi in 9, 15, 21 and 45 element versions. The 9 element is just about a foot in length, lightweight and well made. The quoted bandwidth is 2350-2450MHz and gain of 11.5dBi but gain and match fall off rapidly at

the lower end of the band. The 3dB beamwidth is about 15 degrees, which is quite usable for portable ATV work as a lightweight mast can easily support a pair for duplex operation. Maximum gain seems to be about 10dB over a home made half wave folded dipole. The cost is about \$50 and Directive Systems will ship worldwide



**The latest offering from F1GE, a single stage 13 cm amplifier**

There is one manufacturer here in the UK that produces a 13 cm aerial although it is not widely advertised. Sandpiper Communications based in South Wales supply to order a 20 turn helix for the band. Quoted gain is 17dBi (14dbD) and of course provides circular polarisation. The quoted gain figure seems reasonably accurate. Designed for satellite work the aerial gives good account of itself for terrestrial ATV and gain and match seem constant over the full band. It is rear mounted and about 18 inches in length. It costs £50, and delivery is usually within a week. Unlike Yagis, the local birdlife tends to shun the helix; a very attractive feature to the XYL as her washing whirly is just below the tower....

Feeder is always lossy at 13cm. Ideally hard-line should be used but it is very



expensive and somewhat difficult to work with except in situations where it is meant to be used, such as static links. The shorter the better is a good rule of thumb. Short lengths of H100 terminated with the correct N types seem a reasonable compromise between cost and performance. If possible mount the transmitter and receiver as close to the antenna as practical. In the case of the receiver the pre-amp or down converter should be at the masthead, and this relaxes somewhat the feeder specification. Provided the gain and noise figure of the pre-amp is better than that of the following stage (and in this case feeder attenuation is taken into account) overall receive performance will be determined by the pre-amp. As the antennas are reasonably small and duplex operation is attractive, I avoid changeover relays, preferring instead to use separate feeders and transmit / receive aerials. Video, audio and power cables are all much cheaper than good 13-cm feeder.

as trees get in the way path loss increases rapidly. Scouring the textbooks for amplifier designs a number of snags became apparent. Devices for any power at 13cm are expensive and can be somewhat temperamental and fragile. Availability is also limited, for as new devices come on the market manufacturers tend to discontinue the old ones! On the basis of pounds per watt a ratio of 100:1 seemed to be about the norm on 13cm. A new offering from G3WDG seemed quite attractive therefore at just over £80. A pair were duly ordered and these arrived after a wait of a couple of weeks. The amplifier is only available ready made and consists of two interconnected units; the two stage amplifier itself in a milled chassis and a separate negative bias board. SMA connectors are used for input and output. Carefully connecting it to the F1GE driver ensuring that a good load was connected to the output, the combination produced an indicated 950mW on an MI 6460 power meter. The results when taken portable were

(some rotten broadcaster or Comms company has got there already) or are covered in tree dBs!

Just before the deadline for submission for this article, F1GE contacted me to say he now has available a 1-Watt amp for 13cm. ready made for FF400. (£40 or so at time of writing) A quick exchange of e-mails and getting Folding Francs from the bank (much cheaper than money orders and available in most banks over the counter immediately) the package arrived in a couple of days. The device used in this case is an RF Micro Devices RF2126 intended for GSM /PCS base stations. The bias components are built into the chip and the whole amplifier is built on a small heatsink/PCB assembly. Substituting this amplifier for the G3WDG unit resulted in 900mW output.

Both of these amplifiers could be mast mounted to eliminate feeder losses.

### The quest goes on

13cm is a fascinating band. Once hooked a tremendous amount of fun is available. But for the moment the project is complete. Even the lid has been put on (but not screwed down). G3WDG is developing a 10 Watt PA that might improve the link even further. The law of diminishing returns is fast approaching I feel, but the quest for just that little bit more goes on; perhaps a chainsaw might be a good investment to take down those trees....

### Contact Information

Sandpiper Communications, Units 5/7 Enterprise House, Canal Road, Cwmbach, Aberdare, Mid.Glamorgan, CF44 0AE. Tel. 01685 870425 Fax. 01685 876104

Directive Systems, 177 Dixon Road, Lebanon, Maine, 04027, USA  
[www.directivesystems.com](http://www.directivesystems.com)

RSGB Microwave Components Service (G3WDG), 314a Newton Road, Rushden, Northants, NN10 0SY.  
[www.g3wdg.free-online.co.uk](http://www.g3wdg.free-online.co.uk)

F1GE, 39 Av.de Savigny, 93600 Aulnay Sur Bios, France,  
[www.crosswinds.net/~atv13cm](http://www.crosswinds.net/~atv13cm)



**Top; Directive Systems 13 cm 9element loop yagi; Middle Sandpipers 13 cm 20 turn helix; bottom the 23/24cm cousin of the one above. In the background all of those tree dBs!**

### Increasing Transmitter Power

So to the thorny problem of the most obvious improvement to the link capability; transmit power. Available from the F1GE unit is about 35mW. P5 pictures have been obtained barefoot over 12km line of site paths but as soon

much improved over obstructed paths but still the greatest enemy is trees in full leaf. Buildings do not seem to be so bad, and in fact in some cases seem to be pretty good reflectors. In the Hampshire / Sussex area there are some pimples which look quite promising from the map but are either inaccessible

# Two stage 2400 MHz power amp

By H. Fleckner, DC8UG

(Translation from TV-AMATEUR 117: DL4KCK)

## Introduction

This power amplifier uses the well known GaAs-FETs CLY5 and CLY15 by Infinion (late Siemens). The layout is made for amateur usage, i.e. it is not minimalised and gives an opportunity to divide the stages. Gain is 15 dB over all, with 100-150 mW input it gives 2-3 Watt output depending on the drain-source voltage. With software help it was developed as a "no tune" circuit for simple construction. A kit is available at "Giga-Tech", D-68542 Heddeshheim, Germany.

## Construction

Figure 1 shows the circuit drawing. Both stages are transformed to 50 Ohm at input and output for single usage. Power supply comes through a 78S75 regulator in combination with a DC-DC converter ICL7660 for the negative gate voltage.

Figures 2 and 3 show the layout of both sides, figure 4 the list of components.

On the print side are only hf capacitors, drain and gate resistors and the regulator at the sidewall. All other components are placed on the groundside of the printed circuit; gate and drain contacts are put through with hollow rivets.

The CLY15 must have additional cooling with a sheet of copper (40x10x1,5 mm) having stable heat

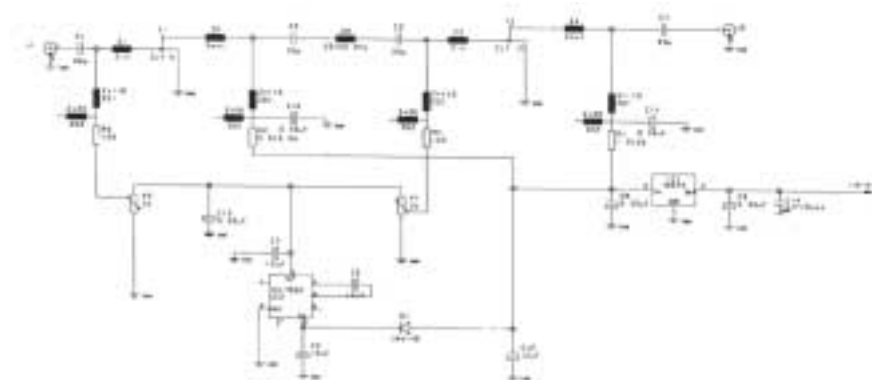

Figure 1

contact to the transistor body. The copper sheet is soldered to the side wall of the metal case, additionally an IC heat sink (51x19x4,8 mm, shortened to 42 mm length) is glued onto it. To ensure the heat contact a bow of 2 mm CuAg wire presses the sheet onto the

transistor (see figure 3).

The regulators power loss is dissipated to a heat sink (97x50x25 mm) at the cases outer side (fixed by 4 M3-screws), the regulator is fixed by one of the screws. The case is a standard finplate case 111x54x50 mm, because of heating the cap should have holes or slits if the amplifier is on continuous duty.

## Putting into operation

At first the gate voltage at both stages should be set to -4 V with P1 and P2, before the drain voltage is applied (made at best before putting in the transistors). The zero-signal current of T1 (CLY5) is set to 300 mA with P2 and at T2 (CLY15) to 1 A with P1, so the total current is about 1,3 - 1,4 A. It is advisable to supply only 10 - 12 V to the amplifier in order to minimise the power loss of the regulator. Output power is increased to 3 W if the drain-source voltage of T2 is raised to 6 - 7 V (R1 only 1 Ohm), but then good cooling is important.

St.	Typ	Hersteller	Bezeichnung
1	CLY 5	SMD, GaAs-FET	T1
1	CLY 15	SMD, GaAs-FET	T2
1	78S75	T0 220, Spannungsregler	K1
1	ICL 7660	DL, K, Spannungswandler	K2
1	1N4148	Si-Diode, 3,9mA	D1
2	2K-Speicherring	Spectral, 64W	P1,P2
2	2,2 Ohm	1 Watt, Metallfilm 0414	R1
4	22 Ohm	Chip-R, 1206	R2
2	120 Ohm	Chip-R, 1206	R3,R4
4	10nF/16V	Tantalido	C3-7,C12
5	0,33µF/25V	Tantalido	C8-11,C13
4	33pF	Keramik-Chip, 1206	C1-4
1	1nF	Durchführungskondensator	C14
2	N-Flanschbochse	kleiner Flansch	J1,J2

1	Kühlkörper	51 x 19 x 4,8 mm	IC-Kühlkörper 8,5°C/W
1	Kühlkörper	97 x 50 x 25 mm	Kühlchiene 1,6°C/W
1	Weißblechgehäuse	55 x 110 x 50 mm	
4	Höhlblech	Cu, l = 1,5 mm, d = 1,2mm	
1	Platine	RO 4003, 0,81mm	
1	Kupferblech	40 x 10 x 1,5 mm	

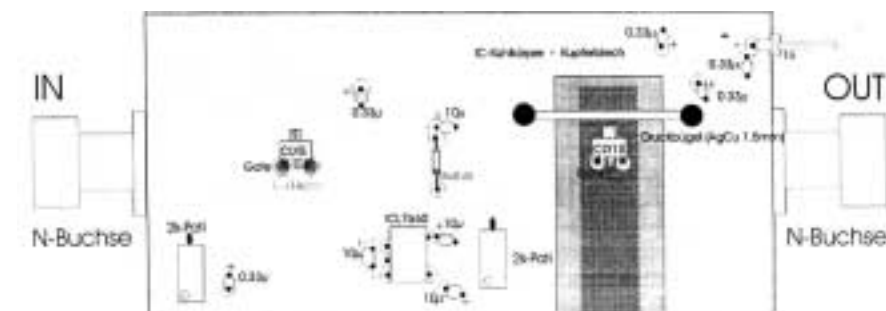

Figure 2

## Measurements

Picture 5 shows the gain characteristic curve of the two-stage amp with 5 V drain-source voltage at 2350 MHz. It is linear until 1,5 W output and makes compression of 1 - 1,5 dB from 2 W on. Picture 6 shows the measured gain characteristic over frequency.

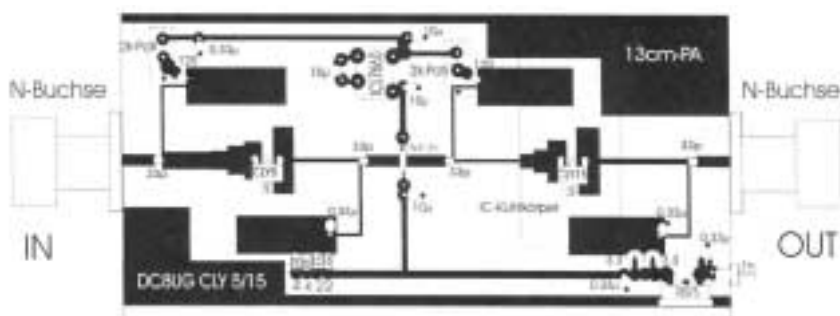

Figure 3

## Dealer reference

Giga-Tech, Friedrichstr. 8a, D-68542  
Heddesheim Homepage: [www.giga-tech.de](http://www.giga-tech.de)

Page 28 (technical feature)

## Putting you in the HD picture

### Anthony Clark looks at one reason why you can expect to wait for Star Wars ion DVD.

The BBC's pre-war tests with TV broadcasting used a mechanical system developed by John Logie Baird above a pub in east London — groundbreaking stuff, but sadly lacking in quality and reliability. The Corporation soon discarded Baird's cogs, chains and spinning discs in favour of an all-electronic 'high definition' (HD) technology that produced a black and white image constructed of 405 vertical lines and 25 frames/s.

The US launched its post-war TV service using a 525-line picture with a 30Hz frame rate and then decided to add colour — albeit rather poorly. Europe responded in the 1960s with a 625-line picture and a vastly improved colour system, PAL, and then things went quiet. Despite refinements in both recording and broadcasting techniques, the basic technology underpinning most of what we watch on TV is eligible for its pension, not least the CRT.

But the advent of digital broadcasting has put HD transmissions back on the map, along with the promise of a greatly enhanced range of channels and services. And while all this may seem to be stating the obvious, what is less clear is how the promised digital broadcasting revolution will shake out — especially for HD transmissions.

As things currently stand, HDTV is being rolled out in America to a less than ecstatic reception. Part of the

problem lies with the chosen technology —ATSC. Some US broadcasters feel that it is not a robust enough system which, when coupled with the high cost of HD sets, has helped dampen public interest. But help may be at hand from the fastest growing consumer electronics product of all time: DVD.

DVD's excellent image quality has garnered it a growing public following, and the news that an HD variant has been developed seems likely to further enhance its reputation. Called hDVD, the new format expands DVD beyond standard definition video to include all of the 18 ATSC video formats, including 1080i (interlaced) and 720p (progressive scan) variants. This translates into an image with up to four times the resolution of standard DVDVideo.

Developed by a partnership between Sonic Solutions and Ravisent Technologies, hDVD uses Ravisent's software-based HD MPEG encoding and decoding technology and Sonic's DVD Creator, DVD Fusion and DVDit' authoring applications.

Christopher Kryzan, senior vice-president of marketing and engineering at Sonic Solutions, said: "hDVD represents a major breakthrough for studios looking to begin deploying HD content today. Working with Ravisent, we have extended the DVD format to include the exceptional video quality of 1080i or 720p MPEG2 HDTV content."

One production company that has latched on to the idea of HD DVD is Lucasfilm. As has been widely publicised, the company has no plans to release any of the Star Wars films on DVD for the foreseeable future. But Star Wars Episode 1 producer Rick McCallum has indicated that Lucasfilm will do so when a next-generation high-definition DVD format becomes available. Until then it is VHS or Laserdisc formats only for the fans.

McCallum has confirmed earlier comments from George Lucas that the Star Wars films would not be put out on DVD until after Episode 3 is released in cinemas, which is expected to take place in 2005. McCallum said: "We expect a new wave of technology to exist in a year or a year and a half." But it is not clear if he was referring to a truly high-definition ATSC-based system or an enhanced version of the current 525-line technology.

But there is a fly in the ointment. While some manufacturers are developing HD DVD and even ultra-definition formats, the DVD Forum has yet to start discussions on a next-generation DVD replacement. And considering the mess made of the format agreement for the current standard (how many players couldn't handle *The Matrix* at first?), it could be many years before a specification is finalised. Even then, there is no guarantee that consumers will accept it.

There is, of course, one key ingredient that gets ignored in the HD debate — the intrinsic quality of the content. For

---

many British viewers of a certain age, 30 minutes in the company of Tony Hancock, via a black and white telecined 405-line transmission of dubious image quality, offers far

greater appeal than two hours of pin-sharp antics from Ace Ventura: Pet Detective. But where's the development money in that?

Electronics Times, 8<sup>th</sup> May 2000.  
[www.dotelectronics.com](http://www.dotelectronics.com)

---

## Masthead power

Powering masthead equipment through the coax is not considered a good idea, at least not in climates that are at all damp. No matter how well you tape up all connections, you still get

electrochemical action in them, leading to corrosion and hence resistance. When every micro-amp of signal counts, you don't want this. All professional installations use a separate

power wire up the mast. It doesn't have to be heavy gauge, even bell wire will do.

---

## Deadline

CQ-TV is published quarterly in February, May, August and November each year. The deadlines for each issue are as follows: -

*February - 20<sup>th</sup> December, May - 20<sup>th</sup> March, August - 20<sup>th</sup> June, November - 20<sup>th</sup> September.*^^

Please send your contributions in as soon as you can **prior** to this date.

Will all prospective contributors please be sure to read the 'Notice to Contributors' on page 1 so that you understand the implications of submitting an article for publication.

The CQ-TV A4 size Word 97/2000 document template can be downloaded from our web site. Select the CQ-TV magazine link from the home page at <http://www.batc.org.uk>

Commercial adverts should be sent to Trevor Brown, the advertising manager, at 14 Stairfoot Close, Adel, Leeds, LS16 8JR. Tel: 01132 670115. Email: [adman@batc.org.uk](mailto:adman@batc.org.uk)

Members' sales and wants should be sent to the Editor. Email: [editor@cq-tv.com](mailto:editor@cq-tv.com)

---

## Flying high

Tandberg Television has conducted the first live digital broadcast trials from an in-flight aeroplane. The Lufthansa Airbus A320-200 (pictured) broadcast live video and audio over a 600km distance from a height of 8000m. The plane's set-up comprised Tandberg's orthogonal frequency division multiplexing based ENG E5100 transmission system and an AVS microwave transmitter.

*From Electronics Times, 6<sup>th</sup> September 2000.*  
[www.dotelectronics.com](http://www.dotelectronics.com)





## Members' Services

		All prices in UK pounds (£)	Each	P&P	Qty	Total
<b>Camera Tubes, Scan Coils, Bases &amp; Lens Mounts</b>						
3	One inch Vidicon base .....	£1.20	£0.30	.....	.....	.....
4	2/3 inch Vidicon base .....	£0.80	£0.30	.....	.....	.....
<b>Video and I<sup>2</sup>C Circuit Boards/Components</b>						
7	Sync pulse generator PCB .....	£12.00	£0.43	.....	.....	.....
40	I <sup>2</sup> C CPU PCB.....	£10.00	£0.43	.....	.....	.....
41	I <sup>2</sup> C VDU PCB.....	£10.00	£0.43	.....	.....	.....
42	13.875 MHz crystal **.....	£4.70	£0.30	.....	.....	.....
70	6.0 MHz Teletext crystal .....	£1.75	£0.30	.....	.....	.....
43	SAA5231 Genlock IC.....	£8.80	£0.30	.....	.....	.....
44	SAA5243PE Teletext IC.....	£14.70	£0.30	.....	.....	.....
45	PCF8583 Clock IC.....	£7.00	£0.30	.....	.....	.....
39	LM1881N Sync separator IC.....	£3.50	£0.30	.....	.....	.....
81	I <sup>2</sup> C 27256 EPROM.....	£9.70	£0.30	.....	.....	.....
38	PCF8574P Input expander IC.....	£4.70	£0.30	.....	.....	.....
10	I <sup>2</sup> C Relay PCB.....	£6.50	£0.43	.....	.....	.....
9	PCF8574A Input expander IC.....	£4.70	£0.43	.....	.....	.....
<b>RX, TX and SSTV PCB's and General Components</b>						
47	70cm up converter PCB.....	£13.50	£0.43	.....	.....	.....
50	108.875 MHz crystal .....	£8.20	£0.30	.....	.....	.....
68	4.433618MHz crystal .....	£3.25	£0.30	.....	.....	.....
69	5.0MHz crystal .....	£3.25	£0.30	.....	.....	.....
86	24cm solid-state amplifier PCB.....	£10.50	£0.43	.....	.....	.....
88	XR215 phase locked loop IC **.....	£5.00	£0.30	.....	.....	.....
<b>Stationery &amp; Station Accessories</b>						
73	BATC blue diamond clutch pin badge.....	£1.75	£0.30	.....	.....	.....
74	BATC cloth badge .....	£4.00	£0.30	.....	.....	.....
75	BATC equipment label (6) .....	£0.25	£0.30	.....	.....	.....
76	BATC square windscreen sticker.....	£0.10	£0.30	.....	.....	.....
78	BATC test card .....	£0.50	£0.43	.....	.....	.....
79	BATC reporting chart .....	£0.10	£0.43	.....	.....	.....

Total Goods and Postage - Amount Enclosed £.....

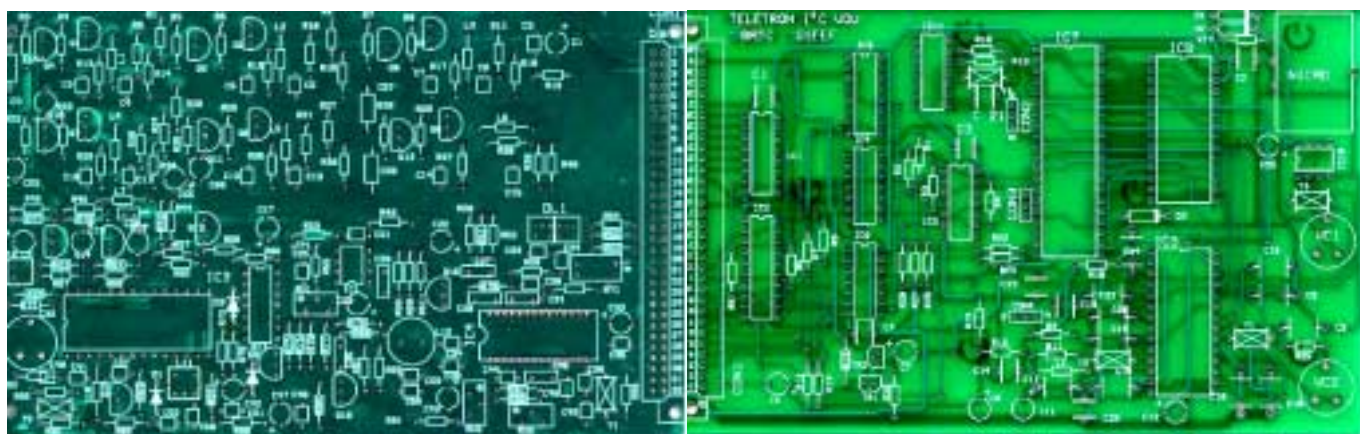

The Sync Pulse Generator PCB (item 7)

The I<sup>2</sup>C VDU PCB (item 41)

The indicated **P&P** prices for Members Services are for postage within the UK only. Will members outside the UK please either try to estimate the extra postage required, or write for a quotation. All cheques **MUST** be drawn on a UK bank. (Eurocheques, in £ sterling, are acceptable). **Items marked thus: \*\* are available only until present stocks are exhausted.**



Members Services orders **ONLY** to: **Mr. P. Delaney, 6 East View Close, Wargrave, Berkshire, RG10 8BJ, England.** Tel: 0118 940 3121 (Evenings, Weekends only please). Email: [services@batc.org.uk](mailto:services@batc.org.uk) Items from these lists can **ONLY** be supplied to **CURRENT** members of the BATC. These lists supersede all previous ones.

A description of the various PCB's and components can be found in the 'What's What' guide, or on the CQ-TV Internet pages at [www.cq-tv.com](http://www.cq-tv.com) (A printed copy available on request, if you send a S.A.E.). Components for club projects are not available from Members Services unless contained within these lists. All club crystals are HC18/U (wire ended). To avoid delay and inconvenience, please be careful to include the correct payment with your order – please do **NOT** send stamps or cash. Post and packing costs are for despatch of one item to United Kingdom members.



The BATC cloth badge (item 74)

**Circuit Details can be found as follows:**

**An Introduction to ATV:** PCB's 10, 40, 41, 47. **CQ-TV 174:** PCB 7

**CAMERA TUBES** A tube guide appears in CQ-TV 149 and 150. Tubes are now difficult to obtain and members requesting information on availability, prices or other types of tubes or equivalents are asked to send a stamped addressed envelope for their reply.

## BATC Publications

Publication	Each	Qty	Total
<b>An Introduction To Amateur Television (225gm)</b> .....	<b>£5.00</b>	.....	.....
The latest handbook full of detailed information on how to set up your ATV station, plus lots of new video and RF construction projects.			
<b>The Amateur TV Compendium (155gm)</b> .....	<b>£3.50</b>	.....	.....
The BATC handbook featuring construction articles on video units, 24cm and 3cm ATV, a Digital Frame Store, and much more.			
<b>The Best of CQ-TV (150gm)</b> .....	<b>£3.50</b>	.....	.....
A compilation of the best construction articles from CQ-TV's 133 to 146			
<b>CQ-TV Back Issues:</b> .....	<b>£1.50</b>	.....	.....
The following issues are still available. Please circle those required: 142, 143, 144, 147, 150, 153, 154, 156, 158 159, 162, 163, 164, 166, 167, 168, 169, 170, 171, 173, 174, 175,176, 177,178, 179, 180, 181. 182, 183, 184, 185, 186, 187, 188			
Special Offer: Any four of the above issues .....	<b>£5.00</b>	.....	.....
189, 190, 191, 192 .....	<b>£2.50</b>	.....	.....
<b>The BATC CD</b> .....	<b>£5.00</b>	.....	.....
Total Goods and Postage - Amount Enclosed.			£.....

Please note that the above books (except 'The best of') and CQ-TV issues 171 onwards are available in Adobe Acrobat format for download from our web site, [www.cq-tv.com](http://www.cq-tv.com). They are also included on the BATC CD. (The CD also contains a full keyword search index) Please note that the versions on the web site do NOT include the colour covers or any colour inserts. This is to improve download times.

The indicated prices for **Publications** include postage within the EEC. Will members outside the EEC please either try to estimate the extra postage required, or write for a quotation.

**Publications** orders **ONLY** to: **BATC Publications, Fern House, Church Road, Harby, Notts., NG23 7ED, England.** Tel: 0152 270 3348 (Evenings/Weekends only). Email: [publications@batc.org.uk](mailto:publications@batc.org.uk). Publications can also be ordered via our web site at [www.batc.org.uk](http://www.batc.org.uk)

**PLEASE MAKE CHEQUES PAYABLE TO 'BATC'.**

# Satellite TV News

## By Paul Holland G3TZO

Welcome to an unfortunately shortened edition of Satellite TV News. This time around we look at upcoming launches, upgrading the Echostar AD3000IP software and have a quick tour of Threapwood Teleport (my back garden!)

## Transponder News

Following the trend of recent editions I have selected just a few of the endless changes to transponder loadings across the various European satellites. For those who have Internet access the most up to date information is at Stefan Hagedorn's site <http://www.sat-hagedorn.de>

### Eutelsat Sesat at 36E

Channel of Hope International has started on 12,711 GHz (H), MPEG-2 clear, (SR 3300, FEC 3/4).

### Astra 2A 28.2 Deg E

The autumn period launch of new services brings a host of new names to Sky Digital including;

Eurosport News Channel, Grocer TV, Screenshop, Community Automotive Channel, Toon Disney, Cartoons from Disney, Playhouse Disney Kids Channel, Disney +1, Biography, History +1, QTV(music channel, Extreme Sports Channel

This latter service indicates the probable appearance of English Language services currently provided by UPC from Telstar 12 would all find their way to Sky Digital.

### Astra 1A,B, C, D 19.0 Deg E

German music TV stations Viva Television and Viva II were due to launch on 1st October 2000. Viva will transmit on Transponder 116 at 12.551 GHz (V) (SR 22000, FEC 5/6). Viva will also launch in analogue on Transponder 44 at 11.127 GHz (V) with Viva 2 following on the 1st February 2001 in analogue on Astra 1A Transponder 7 at 11.303 GHz (H) and in digital on Transponder 116 at 12.669 GHz V (SR 22000, FEC 5/6).

### Hot Bird 3 13.0 Deg E

A digital platform from Korea and Bangladesh has started on 12.219 GHz (H) (SR 6162, FEC 3/4): Arirang TV (V-PID 33, A-PID 34) and ATN Bangla (V-PID 1057, A-PID 1058).

### Express 3A at 11W

ORT is now on 3,675 GHz (RHC), in SECAM.RTS Sat has started on 11,518 GHz (V), in MPEG-2 clear (SR 16000, FEC 3/4).

### Telstar 12 15 Deg W

Tzu Chi TV has started on 12,620 GHz (H), MPEG-2 clear (SR 2440, FEC 2/3)

### Nilesat 102 7.0 Deg W

This Egyptian telecommunication satellite is now co-located at 7 Deg West with Nilesat 101. The Ku-band only transponder plan is shown below – no services were in operation as we closed for press.

12,130	V	12,111	H
12,169	V	12,149	H
12,207	V	12,188	H
12,245	V	12,226	H
12,284	V	12,265	H
12,322	V	12,303	H
12,360	V	12,341	H
12,399	V	12,380	H
12,437	V	12,418	H
12,476	V	12,456	H

## Updating the AD3000IP

Courtesy of Echostar is the following information on updating software version for the combined analogue digital AD3000IP receiver. Initial reports on this receiver complained of a variety of bugs mostly affecting the receiver's capacity to store and manipulate programmed channel data.

Pin 2	Wired to	Pin 3
Pin 3		Pin 2
Pin 4		Pin 6
Pin 5		Pin 5
Pin 6		Pin 4
Pin 7		Pin 8
Pin 8		Pin 7

To download the software into the receiver a PC and a "0-modem" cable are required. The cable should have two 9 pin female connectors wired as follows:

Because there could be different hardware revisions of the receiver sold across Europe, it is NOT possible to download all the software versions into the receiver. Therefore only download the software that appears on your screen after you have entered your current software version.

Install the Echostar fast-loader software and the correct software versions into your PC from Echostar's Web Site at; -

[http://www.echostar.nl/helpdesk/faq/software/ad3000ip\\_sw.html](http://www.echostar.nl/helpdesk/faq/software/ad3000ip_sw.html)

Then follow the following procedure to load the software;

- Connect the receiver with the PC using the "null cable".
- Put the AD-3000IP in stand-by. Start the New-Echostar fast loader by clicking on the icon NewEchostar-Fast.exe. It is possible that an error message will pop up because the loader is default set to Com2. If this message appears just click on OK.
- A menu pops up now. First select first the correct COM port using the COM port setting option. A message will pop up that the COM port setting is changed. Click on OK if you agree with the change.
- Click on the 'DOWNLOAD' button. Select the correct software version for your receiver by using the browse option.
- Note that loading the wrong software inside the unit is very likely to cause software problems and affect the functionality of the receiver so take care.
- Switch on the unit! If everything is OK the message 'dnld' appears on the front panel.
- Don't switch the power off. Wait until the download is finished. After the download is finished the message 'Download complete' appears on the PC screen and the receiver starts up.

Launch Date	Satellite	Launcher	Deg	Payload
000906	Eutelsat W1	Ariane 4 V132	10.0E	28 Ku TPs will replace Eutelsat IIF4
000914	Astra 2B	Ariane 5 V130	28.2E	12 TPs in 11.700-12.500 GHz 16 TPs in 12.500-12.750 GHz
000925	Europe*Star 1	Ariane 4 V133	45.0 E	30 Ku TPs
0009 late	Eurasiasat 1	Ariane 5	42.0E	34 Ku TPs also called Türksat 2A
0010-12	PAS 1R	Ariane 5	45.0W	36 Ku (10.950-11.200 & 11.450-11.950) and 36 C TPs will replace Panamsat 1
0010-12	Astra 2D	Ariane	28.2 E	15 TPs in 10.700-10.950 GHz
0101-03	Eurobird	Ariane	28.5 E	18 TPs in 11.200-11.700 GHz 6 TPs in 12.500-12.750 GHz will replace Kopernikus 2
0101-03	Astra 1K	Ariane 5	19.2 E	46 Ku TPs will replace Astra's 1A,1B & 1C
0104-06	Astra 2C	Proton	28.2 E	32 TPs in 10.700-11.200 or 24 TPs in 11.700-12.200 GHz
0104-06	Intelsat 903	Ariane	24.5W	12 Ku and 44 C TPs, will replace Intelsat 603
0105	Atlantic Bird 1	Long March 3A	12.5 W	28 Ku TPs for Europe & Americas, will replace Eutelsat IIF2

- It is now preferable that the complete unit will be reset to the factory defaults. This will mean restoring all the channels you have found to date!

## Super Seca

Canal Digitaal is reported to be testing the new Seca Super Encryption, a new encryption format to beat the increasing piracy of Seca encrypted services. Many viewers of Canal Digitaal through a pirate Seca card, will have noted temporary scrambling of programmes on transponder 12.515 GHz H (SR 22000, FEC 5/6) at 19.2 degrees east, which is home to; Ned 1-3, Cine Cinemas, Canal+ 1-2, Canal+ 16:9 and Info Kanaal. Recent encryption testing has also resulted in frequent free-to-air transmissions. Canal Digitaal encrypt programming in both Irdeto and Seca/ Mediaguard. No observations have been made of the

new Irdeto 2 encryption from Irdeto Mindport, again to be implemented to combat access through unofficial means. Pirate viewers experiencing the new encryption tests should be aware that their viewing cards might become redundant.

## Launch News

The upcoming months should see the launches of a number of satellites that have been delayed for a variety of reasons. Longest on the list is Astra 2B that should have been launched by the time you read this. Looking ahead to next year we

## New Nokia Receiver

The Finnish manufacturer, Nokia was due to launch a new digital receiver in September, the Mediamaster 9450S for free-to-air reception. The receiver will

offer access to all DVB-Standard television and radio stations. The receiver will feature an Electronic Programme Guide (EPG) with picture-in-picture display and a menu system in English, French and German. Channels will be able to be sorted into 9 different favourite categories with the receiver able to store 1000 radio and TV stations. Like previous Mediamaster versions, such as the 9600 and 9800, the new 9450S will have an RS232 output for software downloads via the Internet and a video and TV scart output. The receiver is expected to be retailed at around £165.

## Post Bag

Thanks to those who have written in with nice comments on Satellite TV News. John Marlow G1ORP e-mailed to ask if the Dutch Amateur repeater PI6ALK is still on Eutelsat W2 at 16.0 Deg E. It can be found 24hrs a day on 12,729 GHz (H) SR 2000 FEC ¾. During the day a test card can often be found with the PI6ALK Ident and in the evenings a mosaic is broadcast with multiple screens showing various shack scenes – not always a salubrious sight!

Barry Gunston responded to the piece in the last issue regarding the SATLOOK III spectrum analyser. Barry had the unfortunate job of repairing one of these units after it had fallen off the back of a lorry – literally. The unpleasant results can be seen below.

The notes on the Satlook unit provoked a few people to write including Jerome Halphen from France who wrote - “ I





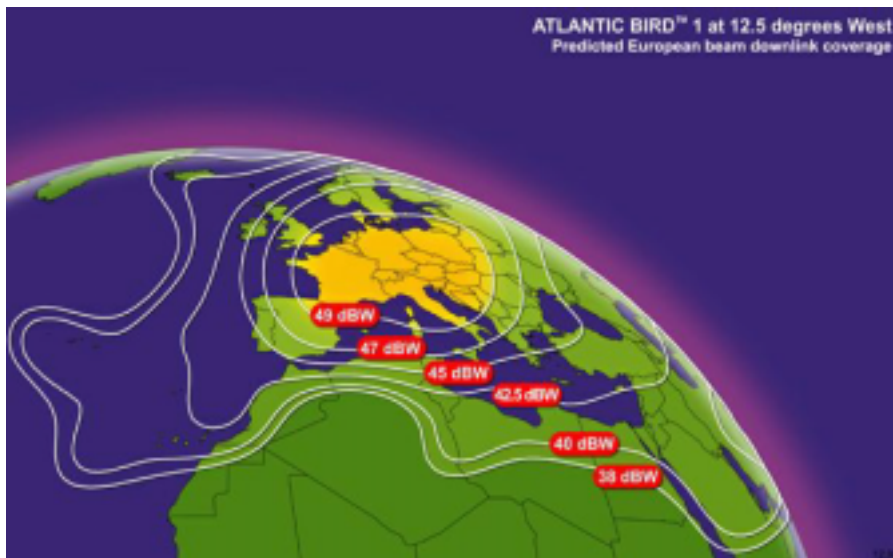

**Atlantic Bird 1 Due at 12.5 Deg W**

really appreciated your advice on using the Satlook III spectrum analyser to tune digital-only satellites. You are right about the near impossibility of correct antenna alignment if the satellite doesn't have analogue carriers to serve as "adjustment beacons". I am, like you, the proud owner of an Echostar AD3000-IP. Unfortunately, I can only use it with a fixed dish on Astra, as my landlord hasn't granted permission yet for a steerable antenna. I purchased the unit in April and it sometimes shows "no signal" on all the digital channels (analogue channels are not affected). If I cut all AC power for a few minutes, they come back. Have you experienced the same sort of bugs with your receiver? Do you know if there are plans for release on the UK market of a conditional access module for Sky Digital? As I live in France, I would far prefer to have a plug-in module for the Echostar rather than having to install a second system with a Sky Digibox." On Jerome's first point

there is now much evidence that early versions of the Echostar AD3000IP software were plagued with bugs – hence the advice on upgrading given above. Unfortunately the answer on Jerome's latter point was no, with Sky resolutely sticking to a policy of an integrated conditional access module.

### Launch of Astra 2B

As we closed for press Astra 2B provided the 10th consecutive successful Astra launch onboard a European Ariane 5 booster from the European spaceport in Kourou on the evening of September 14th. Astra 2B is the second SES spacecraft to be permanently co-positioned at 28.2° East. The satellite carries 30 Ku-band transponders (11.70 - 12.75 GHz), powered by 109-Watt Travelling Wave Tube Amplifiers (TWTAs). Astra 2B is a Eurostar type satellite and was built by Astrium (formerly Matra Marconi Space) and has a design life of 15

years. Once co-positioned with Astra 2A at 28.2° East, Astra 2B will enable SES to activate 40 transponders in the BSS frequency range between 11.70 and 12.50GHz. Astra 2B features a steerable antenna with the facility to activate up to 16 transponders in the 12.50 - 12.75 GHz frequency range outside of Europe, across any area of the earth visible from 28.2° East. Astra 2B is the first European manufactured commercial spacecraft carried by the new European Ariane 5 heavy-lift booster. SES has two further Ariane launches firmed up: ASTRA 2D is scheduled to be launched into 28.2° East in December 2000, and ASTRA 2C is expected to follow suit in the first quarter of 2001.

### Stellat to replace Telecom 2B in 2002

France Telecom and Alcatel affiliate Europe\*Star have formed a satellite venture called Stellat to launch, manage and market a new communications satellite that will replace Telecom 2B at 5 degrees West. The satellite will operate in C and Ku-band providing conventional broadcast services as well as two-way Internet, and will cover most parts of Europe and also Africa. The Ku-band portion (35 transponders) will cover Europe and Northern Africa, offering video services and two-way Internet (the uplink will require 1.0m dishes with an RF power of 2 Watts. The 10 C-band transponders will cover Europe, Africa and the East coast of North America. This capacity will mainly be used for transatlantic traffic. Current Telecom 2B customers will be transferred to Stellat, which is planned for launch in April 002. Alcatel Space Industries, using the Spacebus 3000 B3 platform, will build the satellite.

### Eutelsat W1

On September 6 ARIANE V132 successfully launched Eutelsat's W1 satellite. W1 will go into service at 10 degrees East and deliver TV broadcast, Internet and data services throughout Europe and southern Africa. Its 28 Ku-band transponders will assume the traffic currently provided at 10 degrees East by the sixteen transponders on EUTELSAT II-F4. W1 will enable interconnectivity between Europe and southern Africa as well as communications within southern Africa



**Front View**



## Future Trends

Next year Nokia will be launching an all-in-one box that will offer digital TV, Internet access and personal video recording on to a 20-gigabyte hard disk. The Media Terminal, expected next summer, uses the Linux operating system, the Mozilla web browser and Intel's x86 computer architecture. It will be available in two incarnations: one designed for Digital TV networks and another that's compatible with ADSL broadband services. Like the Sky/TiVo box, it will allow viewers to pause and replay live broadcasts and make timed recordings: in this instance, via the Nokia Navibars user interface. Nokia is unwilling to confirm a price for the Media Terminal largely because it hasn't signed a deal with a digital TV network. An agreement with ONdigital, BSkyB, or NTL could see the product subsidised and on sale for around £200.

## Threapwood Teleport

In all the years producing this column I have not taken the opportunity to include a few pictures of the Dish Farm here at Threapwood. The following pictures depict the antenna set up which consists of the following;

Antenna 1 (on the house wall) is a 60cm offset with Universal LNB fixed on 28.2 Deg East feeding the Domestic Sky Digibox.

Antenna 2 (left foreground) is a centre focus 1.8m motorised dish with



Rear View

Swedish Microwave wide-band LNB feeding the Echostar AD3000IP analogue digital motorised receiver.

Antenna 3 (right foreground) is an offset 1.8m motorised dish with Swedish Microwave wide-band LNB feeding the Echostar LT8700 analogue receiver.

Antenna 4 (Lower garage wall) is a 45 cm mesh offset dish with Universal LNB fixed on Astra at 19.2 Deg E feeding a DiSEqC switch linked to the Nokia 9600 FTA digital receiver and a Pace MSS 400 D2Mac/Pal receiver.

Antenna 5 (upper garage wall) is a 90 cm centre focus dish fitted with a dual output Universal LNB fixed on 13.0 Deg E and also feeding the DiSEqC switch linked to the Nokia 9600 FTA

digital receiver and a Pace MSS 400 D2Mac/Pal receiver

Antenna 6 (obscured behind everything else!) is a 1.5m centre focus dish with a dual output Universal LNB fixed on 1.0 Deg W and also feeding the DiSEqC switch linked to the Nokia 9600 FTA digital receiver and a Pace MSS 400 D2Mac/Pal receiver

All feeders run underground through to the house and then feed the shack and domestic installation.

That's all till next time. Please write using the usual contact details of emails to [paul.holland@btinternet.com](mailto:paul.holland@btinternet.com) and telephone to 01948 770476.

## Is your Subscription due?

Several years ago we introduced rolling subscriptions as opposed to all subscriptions starting on January 1st. This made it easier to administer new subscriptions, as we then did not have to calculate just how much someone had to pay when they joined part way through the year. It also means that we now send out renewal notices quarterly as opposed to them all going out in bulk thus easing the burden on renewals arriving for January.

My record for renewal returns in those days was about 85 letters in one day

and several hundred by the end of the week. A mammoth task to open the letters let alone process the subscriptions.

To save on the costs of posting the renewals we include them with your CQ-TV instead of sending them out individually. A renewal letter will be enclosed if your subscription has recently run out or due before the following edition of CQ-TV is published.

You are now reading the November edition and for many this is the time to renew. A renewal letter will be included if your subscription is due or falls due before the February edition. You can easily check to see when your subscription runs out, it is shown on the magazine address label in the bottom right hand corner. The address label will also show "Subs Due" if they are.

**See page 18 for full details of subscription rates, these rates are also shown on the renewal notice.**

# The STV5730A Character Generator Chip

## A review by Trevor Brown

I have always been interested in character generators and the custom chips that help reduce their complex nature. The first chip I struggled with was the 2513, which I used in a simple diode programmable unit in the blue ATV handbook (See PDF file on our web site or BATC CD). This was just a font ROM and needed considerable effort to clock out the rows and columns to get anything worthwhile, by comparison with the STV5730A which has more meaningful pin notations such as video in, or video out etc.

Before you start turning the page and looking for the circuit to see how to implement this chip, this is already done for you. The Black Box Camera Company are marketing a PCB already populated with this chip and a 16F84 pre programmed PIC to control it; all you have to do is put it in a box, connect the battery and three push buttons and you are in business. The unit costs £25 although for £38 it comes with case, phono connectors for video in and out, keypad and battery connector. All you have to do is press

the three buttons to select your message.

The full character set is displayed with a cursor; the first button moves the cursor to select a character. The second selects the position it is placed in and the third moved the character into place. Stop typing for 15 seconds and the fonts will disappear, leaving your selected message only. Two of the keys will position the message on the screen and select a background. The other brings the fonts back so you can edit your message

What's the snag? Well it's hard to find one. I tested one for Black Box Camera and was pleasantly surprised. The first unit I tested accepted a one-volt composite signal and produced a video output with superimposed characters but only at 0.5 of a volt. A few emails later a new-programmed PIC turned up in the post and the problem was solved. I tried it on a noisy off-air signal first and the characters did not rag. I tried it on colour bars, and - yes - some distortion of the signal was evident - about 6% loss of chroma, and diff phase and gain were present, so if you are not inserting characters, then a

bypass switch might be a good option. This could be combined with an on/off switch as the unit consumes 50mA, so a rechargeable PP3 battery will only last a couple of hours, but for such a handy unit - that fits into the palm of your hand - there must be some compromises.

I have also had beta software from Black Box Camera that works full page, i.e. no input; it generates a coloured background with coloured text. They are experiencing problems in that some monitors reject colour in this mode. This I suspect is a colour subcarrier frequency problem as my monitor locked but my vector scope would not. The unit has a 4fsc xtal and I suspect trimming the frequency of this xtal would solve the problem.

It hard not to like this unit and if you are into PIC software then it would be a nice test bed to develop some very creative software. The Black Box Camera Company can be found at [www.STV5730A.co.uk](http://www.STV5730A.co.uk) or see ad inside the front cover of this CQ-TV. Sample .asm files and a data sheet in .PDF format can also be found on their website.

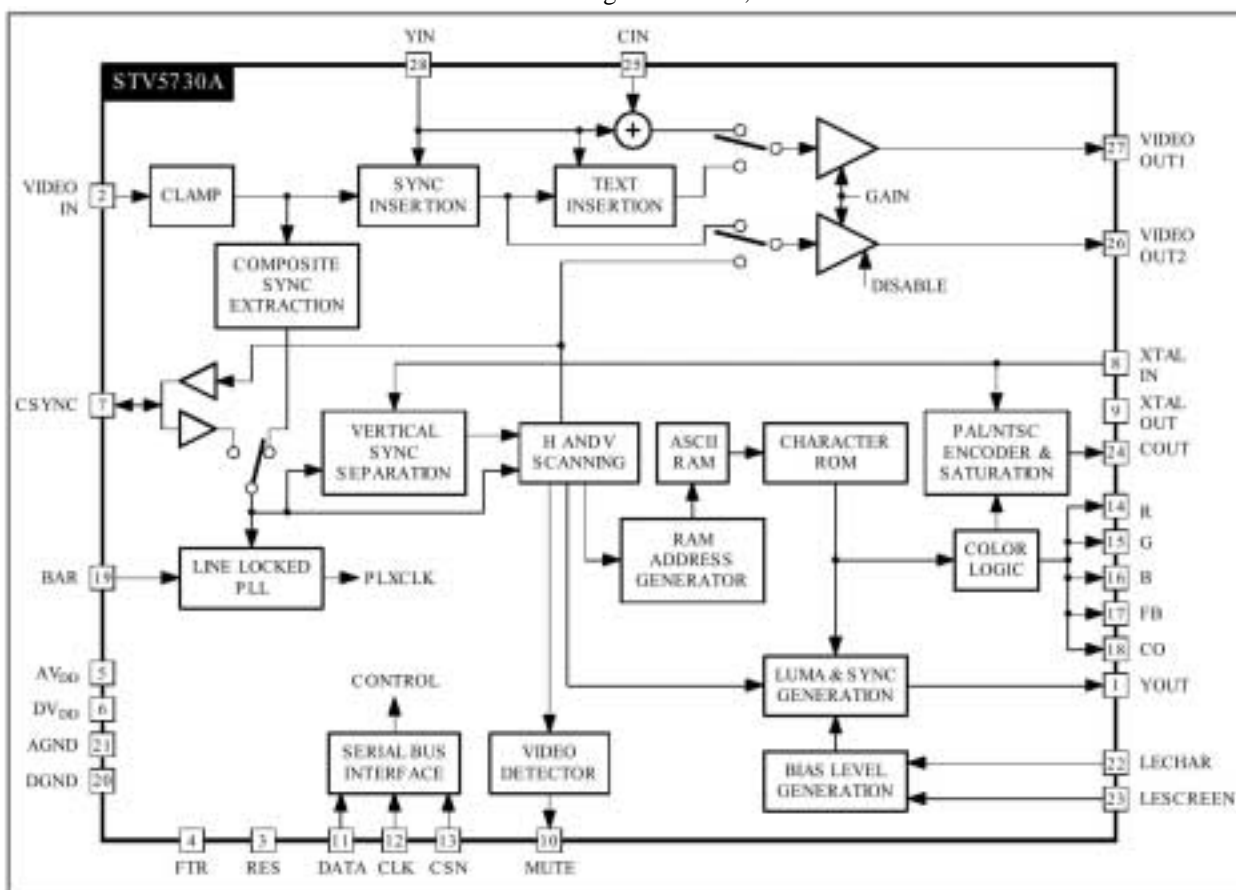

# Mobile ATV in Snowdonia

By Brian V Davies GW4KAZ.

For some time I had been thinking of establishing a mobile / portable ATV station.

This would be an ideal situation for getting me out of the house and the TV studio during the summer months. My ATV studio is located in the roof space of the house, so it's more like a sauna than a studio on a nice sunny day!



**Picture 1 - Shows the view from Site 1 to the Southeast showing the Llanberis area and the foothills of Snowdon.**

We, here in North Wales, have some spectacular scenery. For ATV work this can produce fantastic pictures for transmission. On the other hand, the 1000 meters plus of rock known as Snowdonia, which for many years I have considered an obstruction, when trying to work stations on VHF to the south, now works to my advantage. It offers me access to sites, which are well elevated and have fantastic scenery. **Site 1** (Picture 1)

During this summer I have tested out three sites, all at about 200 metres a.s.l.



**Picture 2 - Shows the Maspro RX, with the 5 in. TV monitor and 19 in. rack chassis for the TX and spare RX.**



**Picture 3 - Shows the equipment plus the video camera firmly held by the headrest.**

to send pictures through GB3TM on our Tuesday night net. The equipment I use is shown in the photograph. This includes: (Picture 2)

A Maspro RX converted to 12v working and a small 5 in. mono TV as the monitor.

A Worthing ATV TX, running about 800mW output, which is built into a 2U high x 19 in. rack chassis, where I have also included a home brew 950 to 1750 MHz RX, made from old Sat TV receivers. This RX may come in handy as a second RX for 10 GHz, with a suitable LNB.



**Picture 4 - Shows the Alford Slot antenna fixed to the mag-mount on the roof of the car, with the view toward GB3TM on the horizon over Anglesey, to the northwest.**

I have two cameras in use, one was marketed some years ago as a fun video camera for children, it is a mono camera with sound output. As you can see it is well anchored down under the headrest! (Picture 3) The second is a colour camera, which was purchased as a basic unit, and fitted into a plastic box. (Not shown in the pictures)

All the above items work well from the 12v DC system in the car. The antenna is a home brew Alford Slot mounted on an 8 in. dia. mag-mount. (Picture 4). The antenna is housed in a suitable plastic tube and is connected to the RX and TX through a home-brew duplexer, so that I can use one antenna for RX and TX simultaneously.

The duplexer was another experiment following on from my article in CQ-TV 190, it works well in this situation. However, I have tested the duplexer on my home station with the TX running 12 W output and it works, but is a little sensitive on adjustment.

No major problems though, even the RX pre-amp was not overloaded. I set up the above equipment on the passenger seat, with the antenna on the roof. I have operated mobile with some success, sending video through GB3TM.

The antenna stays firmly in place even at 40 mph! The distance from the two sites to GB3TM is about 20 miles, (Sites 1 & 2) and, if I pick my spot, I can get P5 signals through GB3TM. The other site is about 36 miles away (Site 3) and here I struggle to get a P2. (Picture 5).

However, with just 800 mW output, it shows that with "a little more coal on the fire" a P5 is more than possible.

What is also interesting about site 3, is that I can receive and access both GB3TM and GB3DW, so there are possibilities here for the experimentation of linking the two repeaters in-band, by using sufficient band-pass filtering and some small beam antennas. **Site 3**. Maybe next summer! Watch this space.



**Picture 5 - Shows the location of mobile sites, plus GB3GW and GB3TM.**



# More Portable ATV Success

**By Ross G0WJR**

Following Phil G1HIA's very successful visit to the hills near Newbury, from where he worked several stations in Hampshire, I received an email message from John G7JTT, who told me of their intention to go out and test their portable ATV gear on 23, 13 and 3cm.

At 9 am on Saturday 5th August, I joined John G3RFL on the Mendips, close to the village of Charterhouse.

To the East of us, John G7JTT, Noel G8GTZ and Steve G7BVK were making their way to Walbury Hill in Berkshire, some 88 km away. The two sites are marked on the contour map, and the terrain profile was calculated from the G4JNT software suite,

This shows that the signals can propagate unobstructed up the Vale of Pewsey. The path loss at 10 GHz was predicted with the same software:

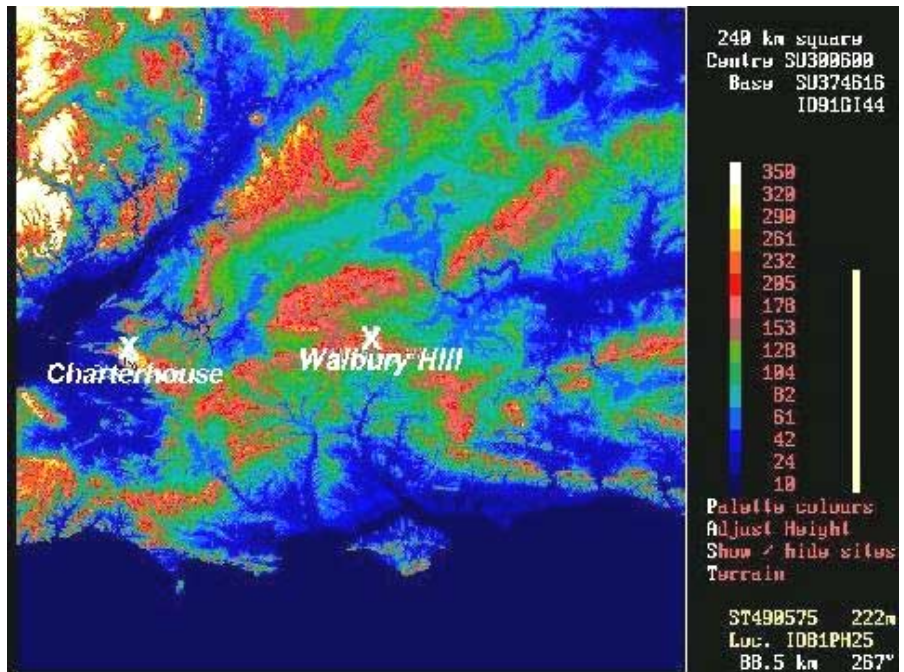

ASL

Base mast height: 2m. Base station antenna beamwidth: 3°. Frequency: 10315 MHz

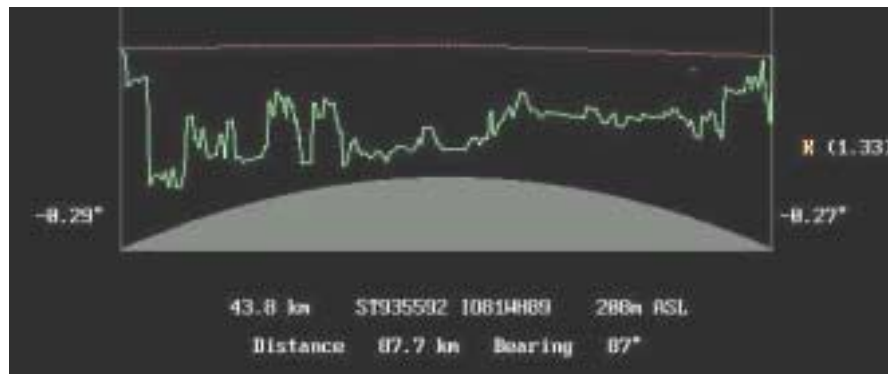

TROPOSCATTER PATH LOSS PREDICTIONS FROM HEIGHT DATABASE

Distant Location: WALBURY HILL SU374616, 299m ASL

Base Location NGR or Locator: CHARTERHOUSE ST498568, 314 m

Mast height: 2m. Distant station antenna beamwidth: 3°

Distance: 87.7km. Bearing = 87° Path is Line of sight. Path loss: 152 dB.

So goes the theory, but would it work in practice? Read on..

Once we'd established talkback on 2m, I turned on my 23cm transmitter, using just one watt to a Jaybeam 15+15 element yagi. G7JTT reported P5 signals almost straight away.

With the link was set up, and video and audio coming from my camcorder, John and I did a tour of our site, taking in Billy Bass, John's 'talking fish' and the two little Mr. Blobby replicas which perched on the 13cm radome! Both John (G7JTT) and Noel had 23cm receive, and each gave me a signal report. We then set up to receive signals from them, again achieved with no difficulty. John (G7JTT) sent me scans of some of the pictures he recorded on the day, 'unfortunately my VCR pictures are not that good, and by the time I grab them on the PC they're even worse...it was in colour but the VCR says otherwise'

My 13cm transmitter produces only five milliwatts, but the signals could be just detected at Walbury Hill. Once I'd connected up my 1W PA, we were back to colour pictures and quieting sound again, and managed a two-way with each station.



G7JTT/P at Walbury Hill



G0WJR/P on the Mendips





**Picture of John and 'Billy Bass' received on 23cm from G0WJR/P**

The most stringent test was left until last: 3cm. John (G3RFL) transmitted a few tens of milliwatts into his electrically steerable dish, but nothing was seen. Trying to measure the frequency, using an LNB and counter, we were having difficulty getting a reading, and so decided to switch to my transmitter. This consists simply of a Solfan Gunn-diode head into a penny feed and a PW Exe dish. The problem of lining up the dishes, which have a beam width of a few degrees, in azimuth and elevation is compounded by the need to sweep frequency to find the signal in the receiver. Using the direction of my 23 and 13cm yagis as a guide, I rocked the dish from side to side by about ten degrees, until I heard a sudden shout of triumph on the talkback. Once the signal had been found, it was a relatively trivial matter to optimise each dish in turn, for best signal. With the link set up, John (G3RFL) was able to net in, beam in, and his signal was seen too.

Both John (G7JTT) and then Noel were able to send us pictures with their dishes, and as a final test, Steve tried a Gunn module with just a 10 dB horn. To our astonishment we could see this too. John (G3RFL) also demonstrated

that he could receive pictures on his LNB alone (without the dish reflector).

The main problem we had on the day was the visibility of the picture on our screens in such bright conditions. I was using a Casio TFT LCD television, and had made up a cardboard cover to shield it from the ambient light, which was quite a success. Unfortunately, John's monochrome monitor had low contrast, and was very difficult to see. Another unwelcome effect of the strong sunlight was a sore red patch at the back of my neck at the end of the day!

We also had a visit from a friendly local Bobby, who was much impressed with the pictures we were picking up, and bemoaned the poor performance that they sometimes suffered on their UHF FM voice links.

Flushed with this success, John (G7JTT) and Noel were keen to try some alternative sites at a greater distance. John's site at Cheesefoot Head did not even give a good signal on the 2m talkback, and so we didn't even try to exchange pictures. Noel's second site, the other side of Basingstoke, was better, but we but we had to use maximum power to get pictures to him over 112 km of more obstructed terrain. We used my 15-watt PA on 23cm, and the G3RFL 11 watt amplifier on 13cm. Unfortunately; we weren't able to see any of Noel's pictures on 23cm, using a similar power. The front-end of my receiver was evidently not as sensitive as the one Noel was using.

As a result of my pictures being received independently by John and Noel's equipment, I was able to add substantially to my score in the



**Picture of Ross and 'Mr. Blobby' received from G3RFL/P on 3cm**

Sevenside Millennium Cumulative Contest. Each of the 3cm contacts, using a mere 10mW over a distance of 88 km, scored over 90000 points, and the whole day's activity yielded me almost twice as many points as I'd scored in the other six sessions put together!



**G3RFL/P on the mendips**

Bad news for Phil G1HIA, who'd just got into the lead in the Contest, but who sadly had to be at work on this day!

Many thanks to John G7JTT for setting up the sked, and to Noel G8GTZ and Steve G7BVK for their help, and of course to John G3RFL for his good-humoured company throughout the day.



**Pictures received by G0WJR/P on 23cm**

---

## CQ-TV Wins Award in 'Spotlight' Competition!

---

**By Graham Hankins**

Electronics and radio hobby magazine 'Practical Wireless' holds an annual competition to find the best magazines produced by the amateur radio clubs and societies around the country.

There are many Club newsletters around, ranging from straightforward photocopied pages of text, up to fully 'desktop published and designed' professionally printed final products. Whatever the 'end product', all have been produced by the keen and voluntary effort within their club to communicate with their membership and, hopefully, encourage others to join. To enter the 'Spotlight' contest, clubs are invited to submit the latest two issues of their publication, with a brief description of how it is produced.

An expert panel assesses the magazines and their production, which award points (maximum 50) and declare a winner. The judges thoroughly scrutinise each entry; how many club members are involved in its production...is text and artwork used to best effect...how effectively does it cover the activities of the Club...would it encourage new members...etc.

After running the contest initially with a single award, the 'Practical Wireless' team soon discovered that two categories of entry would have to be introduced. Local Clubs would compete for the original trophy, the 'Bert's Bell' award (a polished bell, mounted atop a magnificent wooden - maybe mahogany - plinth, with plaque, in tribute to the late Bert Newman



G2FIX) would be introduced for 'national' clubs which almost inevitably would have greater production resources. 'PW' announces the opening of that year's contest in April; the winning entry in each section is announced at the Leicester Rally in September.

This year, 2000, our chairman Trevor Brown took a phone call from PW

editor Rob Mannion G3XFD, congratulating the BATC on becoming the national winner of the 'Bert's Bell' trophy for the quality of its magazine 'CQ-TV', which scored a magnificent 49 out of a possible 50! I expect that the result will appear in an edition of Practical Wireless after the announcement, so I say a big: "Well done to our club, and especially to our editor Ian Pawson!"

---

## Comments from the Membership Secretary

---

Having had the good fortune to manage three weeks summer holiday this year this meant of course that there was three weeks mail on the doorstep when I got home not to mention the 96 emails waiting in my inbox.

All the mail and emails were processed within a few days of returning but I had several letters and phone calls wondering what had happened and why the delay. I do not mind this so long as the phone calls are at a reasonable hour

but please remember we are not a commercial organisation but your Club is run by a group of volunteers carrying out Club duties in their spare time



## Live from MIR

April 17<sup>th</sup> 2000 — Live from Mir, it's amateur night! Radio operators around the world are once more receiving greetings and even digital snapshots from the revived Russian space station. The radio rig could blaze a trail for low-cost communications from the International Space Station as well.

Through the years, residents of the 14-year-old Mir space station have turned to amateur-radio links as an unofficial channel for chatting with earthlings ranging from loved ones to total strangers — and it became an important supplement to the main communication systems in the wake of the 1997 orbital collision that nearly spelled Mir's doom. About 80 schools around the world have participated in cosmonaut chats over the amateur-radio link, said Miles Mann of the Manned Amateur Radio Experiment, North American Division, or MAREX-NA. The link can also be used to send text via packet data, or even slow-scan television images via a system that Mann helped build. When Mir was mothballed last August, the amateur-radio system went into hibernation as well — and for a time it looked as if the Russian government would have to scuttle the station due to a cash shortage. But the Netherlands-based MirCorp agreed to provide millions of dollars in return for the right to use the station for commercial ventures, breathing new life into Mir. Mir's current crew — Sergei Zalyotin and Alexander Kaleri — arrived April 6, and since then they've been bringing the spacecraft's systems back up to speed. The extensive to-do list includes replacing dust collectors, undergoing medical checks and performing scientific experiments. But during their free time, the cosmonauts have also been renewing the amateur-radio contacts. "They have been chatting with old friends again," Mann said. Kaleri asked about the whereabouts of an Australian operator known as Maggie, and by the second day "the whole country had called her," Mann joked. In an exchange with Maggie, Kaleri discussed the beginning of his third stint on the space station. "For the first time, I arrived at the station unmanned ... bez ludei (without people)," he said Sunday.



Tom Daniels

**Cosmonauts bring station's amateur-radio system back on the air.**

**In a slow-scan television image streaked with static, cosmonaut Alexander Kaleri sits in front of a floating laptop computer on Mir. Amateur-radio operator Tom Daniels back on Earth received the image.**

Mann said the equipment "basically worked on the first try once they had reinstalled it," but the reception varies markedly depending on the 150-ton station's orientation with respect to Earth. "It's like six train cars tied together, and sometimes the antenna is shadowed by the station itself," he said. Under the right conditions, radio operators with a simple 5-foot antenna have been able to get good reception, Mann said. Energia, the Russian rocket corporation that operates Mir on behalf of the Russian government, gave the go-ahead last week for the cosmonauts to resume their chats with students. "This is one of the things they like to do, to talk with the kids," Mann said. Schnecksville Elementary School in Pennsylvania was chosen to be the next school on the schedule, and that chat could take place this month, "crew workload permitting," Mann emphasized.

Mann and other amateur-radio operators have proposed setting up a similar system on the International Space Station, a \$60 billion project involving the United States, Russia and 14 other countries. The first crew, consisting of two Russians and an

American commander, is due to take up residence this summer. The Russian government already has established a radio call sign for the new station. Play with a model of Mir Explore the new space station Complete coverage of the International Space Station and Mir Check with MAREX-NA or the American Radio Relay League for links to resources on amateur radio — and stay tuned for updates as the amateur-radio experiment on Mir proceeds. The Associated Press contributed to this report. These pictures taken from: [www.msnbc.com/news/393808.asp](http://www.msnbc.com/news/393808.asp)



Farrell Winder

**A slow-scan television image received by Farrell Winder shows Mir's main module packed with equipment**

## By Dave Webb, G8VSJ

I just happened to be walking round one of these cut price super stores, you know the sort, racks and racks of televisions all tuned to the same channel, all showing a P3 picture, when I suddenly caught sight of a JVC S-VHS video recorder. Well, to be honest, it was the price that attracted me more than the machine - £235.

For some time I have not been happy with the video recorder currently in use at home, so I decided to investigate what seemed to be good value for my hard earned cash. I attracted the attention of a sales assistant and asked a few simple questions about the external video input options, and was rewarded with a look of total non-comprehension. The young sales man quickly explained that the product training they receive was fairly basic and that most people did their homework and just came in to buy the box. I left Grant's shop (think about it,) all fired up and ready to do some homework.

### A brief look at history

We all know that VHS was invented in Japan, but did you know that the world's first home video recorder was BRITISH and designed way back in 1963, by Norman Rutherford and Michel Turner, the TELCAN was sold in kit form to enthusiasts for about £65. Twenty minutes of 405-line video could be recorded on to a 10½-inch reel of quarter inch videotape. Sadly, despite being demonstrated on-air, by the BBC, commercial backing was not forthcoming and Telcan slipped into obscurity. An in-depth article on the

Telcan can be found on page 12.

The basic VHS system we use today was developed in 1976 by JVC, with the first models appearing in Japan and the USA the following year. By August 1977, VHS recorders were presented for the first time in West Germany and shortly after, introduced on to the European market.

### Homework

The local library had several back issues of "Video Recorder Today International" (or whatever it's called). Aimed at the man in the street, it contains semi-technical information in the form of comparison charts and tick lists. Every month a few units are evaluated and the results printed. Reprints of old evaluations are available at reasonable cost, but being naturally impatient I decided to collect some brochures and do my own comparison. I went back to the shop and asked for some nice glossy brochures and to my surprise I was told, "sorry, we don't have any". "OK" I said, "could you demonstrate the machine for me"? I was astounded to be politely told, "no, sorry". I then went down the road to another shop and repeated my request. Again, I was offered a profound apology, but they had no brochures and did not have the facilities to do a demonstration. I decided Edwina's shop had egg on its face, and left.

On my return home I experienced a brief moment of brilliance when the idea to RING JVC popped into my head. Within a few minutes I was talking to a man who understood my problem, and was not surprised at the difficulties I was having. He was able to answer all my questions and promised to send me some brochures.

### Technical Stuff

As far as the user is concerned, the important difference between VHS and S-VHS is that S-VHS recordings will be of a higher resolution than VHS. This is achieved by increasing the FM deviation from 1 MHz centred on 4.3 MHz, to 1.6 MHz centred on 6.2 MHz. (see figures 1 and 2) It sounds very

simple, but in reality, to accommodate the higher frequencies, special multi-layered tapes that provide increased output at the higher frequencies with reduced noise have to be used. For those who understand this sort of thing, the magnetic properties that make this possible are compared below to that of standard VHS.

### Magnetic properties SVHS tape

- Intrinsic coercivity (HC): 79.6 kA/m (1000 Oersteds)
- Retentivity (BR): 190 mT (1900 Gauss)

### Magnetic properties VHS tape

- Intrinsic coercivity (HC): 60.5 kA/m (760 Oersteds)
- Retentivity (BR): 185 mT (1850 Gauss)

The heads used in S-VHS machines are the amorphous type that has been used in professional equipment for some time. They have a laminated structure that reduces eddy currents thus improving the efficiency at the higher frequencies.

An additional 4.43 pilot burst signal is added in the line sync pulse area whilst recording and removed during playback. Its purpose is to indicate by its phase, whether the signal being recorded consists of composite or component video. When recording composite video a 1 MHz luminance component will be present in the chrominance signal that cannot be removed by the chrominance band pass filter. If not removed, this signal will manifest itself as a dot crawl pattern on the picture. A 1MHz filter is automatically switched in when a 90° pilot burst is detected.

To ensure the best possible picture when connecting S-VHS compatible equipment, luminance and chrominance signals use separate pins of a four-pin connector that has become known as an "S-VHS Connector" (what else?). See fig. 3





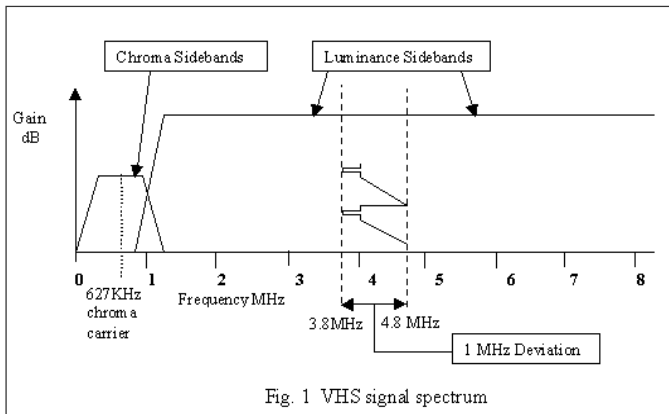

Fig. 1 VHS signal spectrum

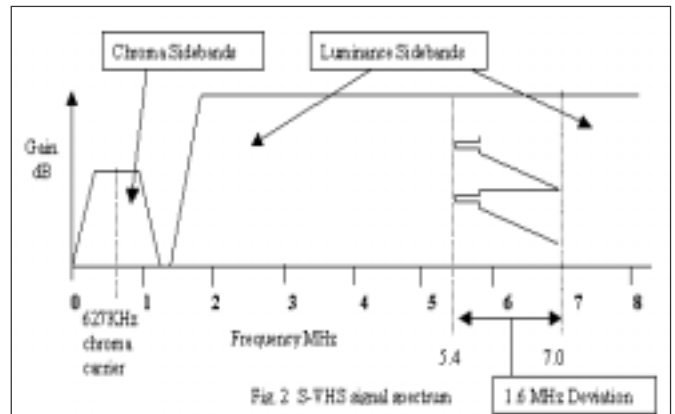

Fig. 2 S-VHS signal spectrum

## Back to the story

Two or three days later the postman delivered to my door, a large plain brown envelope that contained lots of lovely glossy brochures. As I was looking through them, the words “S-VHS quality on VHS tape” grabbed my attention.

It seems that the VHS system has been further developed to the extent that near S-VHS quality pictures can be recorded on NORMAL VHS tapes. This new variant VHS is called Super VHS ET, (do I here the sound of pennies dropping?). The “ET” seems to stand for “Expansion Technology”

Now, I have to admit to being something of a disbelieving so-and-so, and this sounded just too good to be true. The brochure claimed a 60% better picture using ordinary VHS tapes. I decided to find one of these machines and see for myself – but where? Remembering the difficulty with getting demonstrations I went to an old, well-established organisation. I reasoned they might well be more Co-operative. The sales man I approached must have been almost as old as the shop he worked in, but he really new his stuff. It transpired he had worked in the television field all his working life – even repairing the models I designed back in the seventies, (poor sod).

The video recorder I was looking for was a JVC model HR-S6700 and much to my surprise, there was one on a shelf, set up and ready to go. The demonstration I wanted was simply to record a few minutes of a live studio transmission (news programme) on an ordinary VHS tape, and then to playback the tape while flipping between live transmission and video playback, and mentally compare the pictures. This method of comparison may not be very scientific, but it is

probably the best one can hope for given the circumstances.

I have to say that the recorded picture was very good, in fact, with the colour saturation turned off, I was hard pushed to tell the difference between recorded and live transmission. The deal was struck, and I walked out with a new video recorder.

## Three months later

I am still very pleased with my purchase. It has three main recording modes –

1. Normal VHS - As you would expect, normal VHS is for compatibility with other non-super machines.

2. Super VHS – This mode offers the best picture quality possible on this machine, and believe me it’s good. The only down side is that you have to use S-VHS tapes.

3. Super VHS ET – This is the mode I use all the time. Picture resolution seems to be as good as S-VHS, but is slightly dependant on tape quality. Non-branded tapes tend to show a little more noise on the re-played picture.

I tried to get some technical data on Super VHS ET but, sadly, JVC was not forthcoming with information. If any reader can supply any information relevant to Super VHS ET, I would be happy to pass it on to you. My e-mail is [dave\\_webb@proweb.co.uk](mailto:dave_webb@proweb.co.uk)

## Odds and ends

You may have noticed the letters “HQ” on some machines over the last few years. From what I have been able to dig up while preparing for this article, there are apparently six to eight differences between a standard VHS

machine and an HQ VHS machine. Not all of these things need be implemented to call the machine ‘HQ’. I understand one such difference may be little more than a change to the white clip level in the modulator.

For interest, I am including connection information on the SCART and S-VHS connectors.

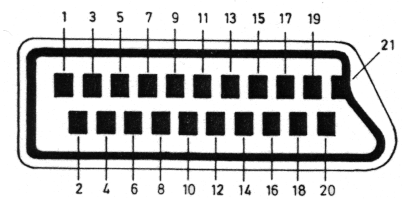

1. Audio output right
2. Audio input right
3. Audio output left
4. Audio earth
6. Audio in left
8. Function Switching
13. Chrominance earth
15. Chrominance
17. Video earth
19. Video output
20. Video input
21. Socket earth

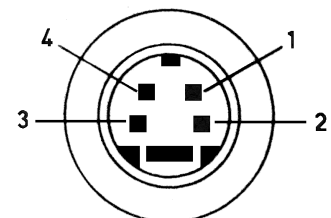

Fig 3

1. Video
2. Video earth
3. Chroma earth
4. Chrominance

## TFT LCD.com monitors reviewed

By Peter Longhurst, G3ZVI

I got a phone call from Giles Read, G1MFG, the other day. "Would you like to review my new range of LCD TFT monitors?" was the question. Would I ever! I've always liked LCDs, ever since I saw my first smeary, black-and-white effort on an ancient laptop. Since then I've owned a few LCD screens, including a couple of LCD pocket TVs, but I haven't been impressed with them. It's only the new generation of expensive laptop TFT's and desktop monitors that have really caught my eye recently, and they've always been way too expensive to contemplate. Anyway, as calmly as I could, I told Giles that I'd grudgingly make time in my busy schedule to take a quick look at his wares.

Sure enough, a few days later, four boxes arrived. I unpacked them eagerly.

The four monitors ranged in size from an uncased 4in module through to a rather splendid 5.6in one that wouldn't look out of place on the set of Star Trek!

All of these monitors run off 12V DC at less than 1A and take standard 1V pk-pk composite video.

### 4in uncased module

The uncased module is, as its name implies, a bare display with an exposed PCB that contains the PAL decoder and an inverter for the backlight. Input connections are very simple - a flying lead with a phono socket for video, and a piece of stranded bell wire for 12V DC. The faceplate of the module is covered by a piece of transparent blue film, presumably to ward off scratches during assembly.

I connected power and video to the module and after a second or so was greeted by a bright image. The resolution wasn't brilliant (although it's better than most pocket TV's), but the colours were strong and the contrast was pretty good. There are no proper adjustable controls, but there are some sub-miniature pots on the PCB which provide colour saturation and



The 5.6in Monitor

brightness control. The monitor seemed pretty well set up, so I left these controls alone. The horizontal viewing angle was fair, at about 30 degrees either side. In contrast, the vertical viewing angle was quite limited. It didn't take much of a tilt before the image became dark (when viewed from above) or washed out (when viewed from below).

G1MFG rightly points out that the display should be cased before use, not least because the output of the inverter can give you a nasty bite if your fingers stray too near.

Although there wasn't a speaker provided, there appeared to be audio inputs on the PCB and what looked suspiciously like a stereo audio amplifier. No data was supplied on these connections, and I was unable to test them out in the time available.

Resolution is quoted as 660 x 160 pels. When I asked what a 'pel' was, Giles

said that it was an individually addressable picture element. Roughly translated, that means either a red, green or blue pixel. Apparently, the reason that the resolution is quoted in pels is something to do with the fact that the display can subjectively manage a higher horizontal definition than the 220 RGB pixels would suggest. This is largely because the dots are round and arranged in a delta formation, so each line is offset by 50% from its neighbours (which means the resolution is sort-of a cross between 220 and 440 pixels). The monitor does appear to give better horizontal resolution than most small colour CRT's I've seen. Vertical resolution is limited to 160 lines (about one-third of full PAL vertical resolution). Overall, the picture quality and resolution is fairly good, especially considering the limited number of pixels (or pels!).



## 4in cased monitor

The cased version of the 4in module performs pretty much the same as the uncased one, except that it has got front panel controls for power, brightness, colour and volume. There's also a green LED power indicator, a 3.5mm headphone socket, and a 3.5mm A/V In socket on the front. The rear panel contains the 2.1mm power input socket and another 3.5mm socket for video and audio. A short patch lead is provided, consisting of a 3.5mm stereo plug to two phono sockets so it's not too difficult to make the video and audio connections. At the bottom of the monitor is a small threaded brass insert that is a standard tripod mount, so it should be possible to cobble together some sort of solid mounting for mobile use.

Picture quality was pretty similar to that of the uncased unit, which isn't terribly surprising because they use the same display panel. There is a large black border around the active area of the screen: presumably, this case is also designed for use with a larger display panel.

Audio quality was, well, adequate. There's a small speaker built into the back of the case and run from an internal 1W amplifier. You wouldn't really want to run it too loud, though, because it's a bit tinny and rattly. The headphone socket can also be used to drive an external loudspeaker, which may be a better option for shack use, but at least there's some audio for portable operations!

The case isn't very inspiring. It's really nothing more than a square box with a hole in the front for the screen, and cutouts for the controls. It looks like a box designed by an engineer rather than one from the marketing department! There are a lot of ventilation slats at the back, and the monitor does run reasonably warm.

Overall, the two 4in displays provide an image quality that is streets ahead of a typical STN TV, but the resolution isn't as good as some flip-out camcorder displays of a similar size. The brightness and contrast is pretty good although the illumination isn't as even as I'd have liked, with slight but distinct bright patches at each corner. Oddly, in terms of display quality, I'd

have to rate the uncased unit slightly higher than the cased one, but that might just be down to the way that the brightness and colour were set up on the PCB.

## 5in monitor

The 5in monitor is an interesting beast. Cased in black, the screen is hinged onto a large foot that also provides space for the various controls and connectors. The quality of the casing is good, with lots of interesting curves. It seems to be made of reasonably strong plastic, and is fairly rigid. The screen can hinge almost 180 degrees, meaning that it's possible to set it up for comfortable viewing from any angle. The hinges had just the right amount of stiffness. Two small speakers are built into the stand, facing upwards, and provide reasonable audio quality.

Connections are made at the back of the stand. There's a 2.1mm power-in socket for 12V, phono sockets for video, left and right audio, plus a 'flip' switch which turns the display upside down. Presumably that's so that you can mount the monitor on the ceiling! On the right hand side are controls for

brightness, colour and tint (for NTSC use). Out of interest, I twiddled the tint control on a PAL signal and all that happened was that the horizontal definition became rather soft. On the left of the stand are the power switch and volume control.

The picture quality of the 5in monitor is pretty darned good. It's crisp and bright, and the contrast is better than that of the 4in one. Resolution is much improved at 960 x 234. This results in a picture that is about half full PAL definition vertically, and (subjectively) about 2/3 resolution horizontally. Colours were accurate, and the PAL decoder made a good job of decoding anything I flung at it. At the time I tested this model, I didn't have access to an NTSC source, but it's supposed to auto-switch to NTSC - let me know if you manage to DX the States on 23cm!

## 5.6in monitor

The 5.6in monitor comes complete with a natty little swivel and tilt stand, which can either mount into a standard tripod type hole at the bottom of the monitor, or (with a supplied adapter) into a slot at the back of the unit. The bottom of

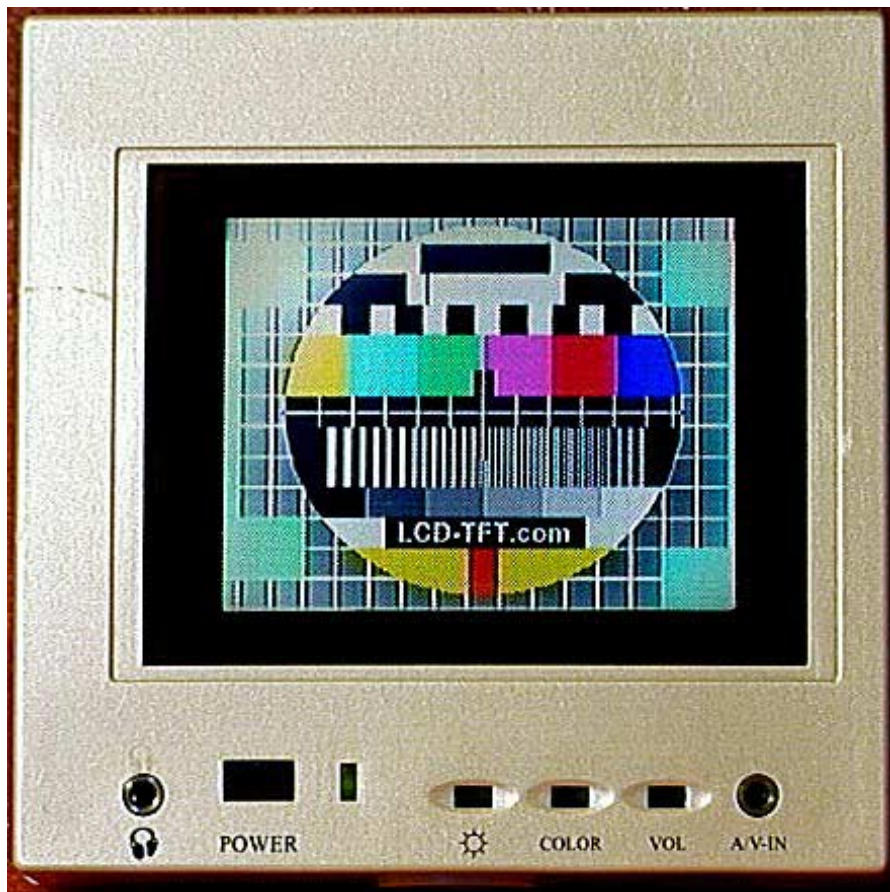

The 4in Monitor

the stand has got a large self-adhesive pad covering almost its entire surface, so it should be possible to provide a really firm mount. The casing is of superb quality, and is finished in silver and grey. There's a black bezel around the screen itself. The most surprising thing about the monitor is that it's only 30mm thick, and its good looks would grace anyone's shack or mobile set-up.

Unlike the other two cased monitors, connections are made to the 5.6in unit via a short flying lead that terminates in a 4-pin mini-DIN plug (like a S-VHS connector). A 5m extension lead is provided, as is a breakout box which gives phono and 2.1mm power-in sockets for video and power, plus hard-wire connections for the same. There are also some additional wires, which are associated with the 'audio select' function (not required when the unit is used as a straightforward video monitor). There is no built-in sound on this monitor, which is a bit of a shame. Also unlike the other monitors, the user controls take the form of pushbuttons along the top, rather than analogue switches. Left to right they are power, normal/mirror (more about which later), audio select (not used), colour saturation up/down and brightness up/down. The brightness and colour controls worked well, although it seemed OK to leave the monitor on its default settings. On the back of the monitor is a small PAL/NTSC select button.

Luckily, when I was testing this monitor I did have access to an NTSC source, and the results were most acceptable.

The normal/mirror button cycles the display between normal, horizontally mirrored, vertically flipped, and flipped and mirrored. This is because the monitor was originally intended for use as a reversing aid (with a colour camera) in large vehicles, and it could thus be mounted in any attitude and still give the right picture. As far as ATV is concerned, there's no real use for this feature apart, perhaps, from persuading beginners that the aerial is installed upside down...

Performance of the monitor is immaculate. The picture is bright, high resolution and contrasty. The viewing

angle is quite wide, and the screen is very evenly illuminated.

### Daylight viewing

GIMFG claims that the monitors are daylight viewable, so I put it to the test. I took the three cased monitors outdoors on a sunny August day (remember August?) and tried them in direct sunshine (with the sun directly on the screen), in direct sun but turned 180 degrees away, and in the shadow of my house. I thought that would be a reasonable test.



The 5in Monitor

Generally speaking, the monitors did pretty well with the sun shining directly onto the screen. It was certainly possible to see the image, although the viewing angle was a bit critical. It was necessary to angle the screen for best results, and also to avoid reflections of my face! This contrasts sharply with CRT's, which as we all know are hopeless in direct sunlight.

Things were better with the sun on the back of the monitors. The 5in and 5.6in ones were particularly good, with a very acceptable picture. Even the 4in monitor coped well with the high brightness, provided care was taken to avoid reflections.

In shadow, the monitors worked pretty well. All three produced bright, vibrant images, with none of the washed-out

look that you get from a CRT. I suppose this is a more realistic test for portable operation, and all the monitors performed excellently. The 5in and 5.6in monitors were marginally better than the 4in one, but any of them beats the pants off a CRT.

Overall, the sunshine test showed that generally the larger two monitors performed better, but it was a close-run thing. Certainly, any of these units will work admirably for portable or mobile operation (and of course they're much lighter and less bulky than CRTs).

### Conclusion

So, are the days of the small CRT numbered? I certainly think so. All of these monitors are priced about the same as 6in portable TV but are brighter, usable in sunlight, and much less bulky. Resolution too is better than the CRT on a comparable size portable TV.

All of these monitors knock spots off the cheap LCD TV's that some of us have pressed into service for portable use. The display is brighter, colours are much more vibrant, resolution is a lot better and there's none of that dull smeariness you get from the cheaper STN screens.

But which is the best? I really liked the style of the 5.6in monitor, and it was the winner (just) in terms of picture performance. However, I think my vote has to go to the 5in one. The built-in audio is the real winner, and the tilt stand is more than adequate for the task. The swivel feature of the 5.6in is nice, but it's no problem to position the 5in stand at the right angle, then adjust the tilt angle to suit. I want one for Christmas.

The 4in module costs £120, the 4in cased monitor is £150, the 5in monitor is £175 and the 5.6in model can be yours for £195. Full details are available on Giles' web site, [www.lcd-tft.com](http://www.lcd-tft.com), or you can get a spec sheet by sending a large SAE to Giles Read (LCD-TFT), L'Eglise, Durlley Street, Durlley, Southampton SO32 2AA.



---

# Worthing Video Repeater Group



**GB3VR GB3RV & GB7VRB**



[www.videorepeater.co.uk](http://www.videorepeater.co.uk)

## 1Watt FM-TV 24cms Transmitter

The 1 watt transmitter generates its signal at the wanted frequency which can be set anywhere in the band, colour or B/W. On board intercarrier sound and fixed pre-emphasis are standard features. The kit includes the PCB all the on board components, pre-drilled heat sink, an Eddystone Di-cast box and full and comprehensive instructions. Building time is three evenings work. The new price for this kit is £85.00, P&P £2.50. Available to licenced radio amateurs only.



## Two channel phased locked loop kit.

This add-on kit vastly improves the overall stability of the 1-watt transmitter two crystal locked channels and a third free running tuning position are available. Kit price £30.00

## Amiga ATV Program-2

The New Amiga ATV program has more features than ever, up to 56 testcards, 20 wipes, superb text control, 30 screens of text messages, QRA calc, Testcard music, selectable displays, and this version has a DTMF tone pad to control your repeater. All testcards are over-scan i.e. the whole screen is used, Load in your own customised testcards, Extra large text, scrolling text, clock, callsign extensions, Hot key operation, Doc reader, ATV Cli, Cross Hatches, Purity and a comprehensive section for genlock users. For any Amiga with 1meg or more, state callsign and QRA (if known) when ordering, this three disk set is now only £10.00 P&P 75p

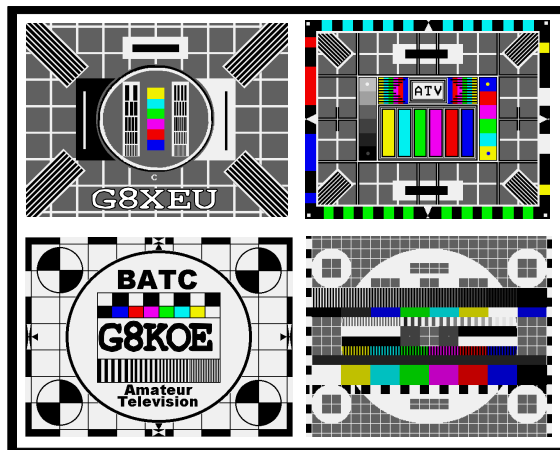

## Video AGC Kit

The Video AGC is capable of excepting signal levels in the range of 0.15Vpk-pk to 2.5Vpk-pk and generating a constant output level of approximately 1Vpk-pk Kit. Price £20.00 + P&P 75p

PC-ATV now available, see web site for details.

Visit the all new GB3VR-RV web site at:- <http://www.videorepeater.co.uk/>

Orders should be sent to: -

Treasurer of GB3VR, R. Stephens, 21 St. James Ave., Lancing, Sussex, BN15 0NN.  
Cheques payable to "WVRG" Tel (01903) 765760 7 to 8pm.

# The Story of GB3GW

By **Derek G. Whitehead.**  
**GW3FDZ**

GB3GW was conceived, designed and built by the Arfon Repeater Group to cover the west coast of Wales (Cardigan Bay) and to supplement GB3TM (located at Amlwch on Anglesey) that covers the north coast of Wales.

The original idea was to install the repeater at Arfon, an NTL site (half way between Caernarfon & Porthmadog) where GB3AR (one of the Group's two metre voice repeaters) had been located for a number of years. Two years ago tests were carried out with successful results into the surrounding area and even Eire. Subsequently however, due to NTL substantially increasing their site fees for amateur installations it was realised that the project would not have been financially viable, so an alternative site had to be found.

As the Arfon repeater group already had packet and voice repeaters at a commercial communication site further north, permission was requested to locate GB3GW at a similar commercial site located at Pentrefelin which is northeast of Criccieth and which gave excellent coverage of Cardigan Bay (and at a sensible rent!).

This is where GB3GW now resides along with a two-metre repeater GB3DW that replaces the coverage lost by GB3AR. (Which also had to be removed from the Arfon site and is now located at Waunfawr covering the northern part of Wales.)



The equipment of GB3GW consists of the following items. A Maspro Satellite RX (modified for auto switch on) preceded by a low noise pre-amp obtained from Main Line Electronics of Leicester. The transmitter consists of a Frequency Synthesised VCO purchased from Eisch-Kafka Electronic of Germany (See CQ-TV 185 & 186.) followed by a Mitsubishi M67715 power module driving a further Mitsubishi power module M57762 giving an output to obtain the 25 watts ERP. A PLL 6.0 MHz FM sound carrier was added to complete the installation.

The logic control and beacon mode requirements are handled basically by I<sup>2</sup>C circuit boards obtained from the BATC Members Services with software kindly written by Chris Smith G1FEF and updated by Graham Denton

G8VAT. (The software is identical to that used in GB3TM but rewritten for change of call sign and location data etc.) A Sony CXA1145P/M brick converts the R.G.B. output of the logic to composite video.

Power requirements consist of +12V, -12V, +5V and -5V. A separate variable +13.8V power supply is used for the transmitter output stages. All power supplies are monitored with over voltage protection. The loss of any supply or over temperature of the P.A. will result in a complete shutdown of the transmitter.

The antenna system consists of two Alford slots purchased from JVL Electronics of Hayling Island, Hampshire; mounted inside a suitable length of plastic drainage pipe and mounted on a base of scaffolding poles designed to sit on a flat roof.

So far so good, however the worst was yet to come. The license granted an output frequency of 1310MHz with an input frequency of 1280MHz. This is the first time to our knowledge that a separation frequency of only 30MHz has been assigned and we believe that we are the first ATV repeater in the country to be operational with such a tight restriction.

Suitable bandpass and band stop filters were however designed and built by

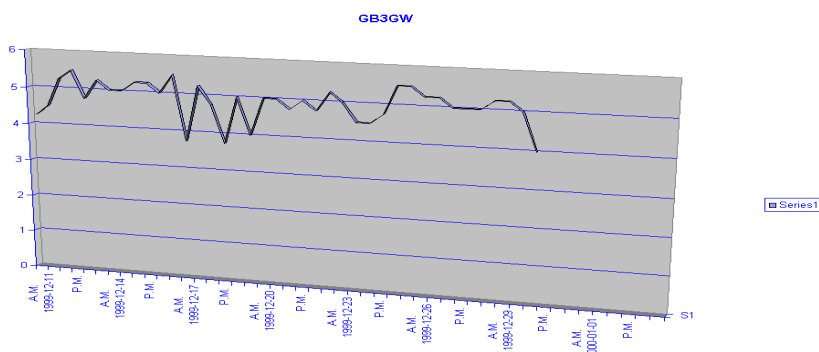

Received Signal Strength Dec 1999. GW0GZQ



**Pentrefelin Site**

our Chairman GW4KAZ which to date are working admirably. (See CQ-TV 190)

GB3GW sprang to life in December 1999 in beacon mode only (due to a hold up in critical necessary filter components) but became fully operational at the end of January this year.

Coverage appears to be better than anticipated with GW0GZQ located at



**Alford Slot Antenna**

Moylgrove south of Cardigan at a distance of sixty miles being a regular user. At present there are four other operational ATV stations in the reception area. GW0SEO located at Llanbedrog, GW1TPS located at Harlech, GW6IMS at Minffordd and myself, GW3FDZ at Dyffryn Ardudwy.

Thanks must go to John Lawrence GW3JGA for advice and guidance, GW0AYQ Bob Smith, for help in equipment construction, Bill Jones for

antenna design and construction and MW0BQO (Endaf) and MW1KDP (Max our Antenna Rigger) for valued assistance in installation.

To finalise, no equipment failure has occurred to date other than a recent loss of mains power due to an electrical storm.

---

## Newsflash

### **Dublin ATV Repeater received in North Wales**

Brian GW4KAZ and Dewi GW0ABL, were operating a portable ATV Special Event Station GB2VK at the Old Marconi Site at Waunfawr, near Caernarfon, North Wales on Friday 22<sup>nd</sup> September, 2000.

On tuning the 24 cms band, signals from the Dublin ATV Repeater EI4DVR were received at P3 under what appeared to be 'flat' conditions. Distance, approx 84 miles, 135 km.

The receiving set-up was a modest Bow-tie aerial, a pre-amp and Maspro Sat. Receiver.

Submitted by GW3JGA, further details from GW4KAZ

---

# Subscriptions are now due!





## ‘Repeater’ is the premier ATV magazine in Holland.

Repeater is a new ATV magazine published in the Netherlands in Dutch. The 13/24cms TX in this issue is reprinted from Repeater with the kind permission of the Editor Rob Ulrich PE1LBP. I hope we can from time to time bring you other extracts as we do with all the ATV magazines.

Information about ‘Repeater’ magazine can be found on their web site at <http://www.euronet.nl/users/rulrich>, email: [repeater-nl@rocketmail.com](mailto:repeater-nl@rocketmail.com)

Snail mail:- Gibbon 14, 1704 WH Heerhugowaard, Netherlands.

## Confidential Communications Ltd

### Video Surveillance

Design Your Own Professional Video Surveillance. Smallest pinhole camera in the world 15mm x 15mm (B&W) £29.00

32mm x 32mm Board camera, pinhole, high resolution (B&W) £29.00

32mm x 32mm Board camera (colour) £65.00

B & W Quad £79.00

Colour Quad £350.00

Picture in Picture with alarm input £299.00

1.394GHz video transmitter module, 100mW £85.00

2.4GHz video transmitter module, 10mW £85.00

1.294 - 1.3 GHz Linear PA 2W output £250.00

Four channel video receiver module with auto switcher £120.00

Time & Date Generator Module £42.00

Time, Date & Character Generator Module £65.00

5W infra-red light source £25.00

Audio amplifier module £7.00

Convert your VCR to automatic video recorder £45.00

4" LCD monitor £190.00

6.8" LCD monitor £290.00

We also stock RF parts such as Power Modules, MMIC's, RF transistors, etc...

Above prices are subject to VAT and are for one unit order, 10% discount for 5 or more.

Confidential Communications Ltd., 344 Kilburn Lane, Maida Vale, London, W9 3EF, England.

Tel: 0181 968 0227

Fax: 0181 968 0194.

e-mail: [106075.276@compuserver.com](mailto:106075.276@compuserver.com)



---

## Post and News

---

Please send all correspondence for **Post and News** to the CQ-TV Editor. Ian Pawson, 14 Lilac Avenue, Leicester, LE5 1FN, England.

Tel: 0116 276 9425.

E-mail [editor@cq-tv.com](mailto:editor@cq-tv.com)

Trade adverts should be sent to the advertising manager, Trevor Brown, 14 Stairfoot Close, Adel, Leeds, LS16 8JR.

Tel: 01132 670115.

Email: [adman@batc.org.uk](mailto:adman@batc.org.uk)

---



---

75 Southmeade  
Maghull  
Liverpool

Dear Editor,

I have just purchased both 13cms RX/TX modules from Giles Read as advertised in CQ-TV 191. I am writing to say how delighted I am at their performance. I have just completed tests over a path of 24km from Ormskirk, Lancs. To Dennis G3UVR on the Wirral and was receiving P5 signals from Dennis who was running 200mW.

My return TV signal running the module on its own (No amp) at 8mW was P3-P4 with Dennis.

My antenna was a 14 element home constructed JVL type loop. The coax was just 8 feet of RG58 (not the best type) with various plugs and sockets so not the best set-up for 13cmsTX and RX.

I can highly recommend the above modules to other readers and members as an easy and very cheap way to get started on 13cms with the very minimum of equipment. I have also heard very good reports of and about his 23cms modules which I will also be purchasing.

Yours, Ken Barnes, G8GTT

---



---

### From the Internet

The ATVQ ATV Repeater director was just updated and includes around 180 ATV repeaters (more than the ARRL directory) all over the world - and is FREE for the downloading at: <http://www.hampubs.com>

---



---

### HOMOLOGATION OF A NEW EUROPEAN ATV RECORD

1042 km the 1981 march 3 at 17h ON5ID - EA1CR, QSO bi-directional B5 ON5ID: JO10RN, EA1CR: IN73EM. The complete list of all

actually homologated ATV records is on <http://www.von-info.ch/hb9afo>

To all,

As many of you are aware, or involved with, plans have been submitted to the RSGB/RA for Northern Ireland's first ATV repeater. This repeater will be in the 24cm band. We are pleased to say that we have passed the first stage of verbal approval and the very early stages of written! All our originally applied call signs were in use, but I think that you will agree that the one we have now received written RSGB permission to use is excellent. Once fully approved, Northern Ireland's first ATV repeater will be GB3TX.... I hope that all involved in the Amateur media will publish this up and coming repeater. All will be kept informed of its progress, alternatively you can visit the Amateur Repeater Group for Northern Ireland's (ARGONI) website @ [www.argoni.org](http://www.argoni.org) for further information. All components are now in stock and the repeater needs only to be fully approved for immediate (within hours) switch on!

Fingers crossed for the next stage!!

Best regards, Tony Wise (Technical Director)

---

## Contest calendar

---

### Winter Cumulative 2001

Tuesday Jan 2<sup>nd</sup>, Wednesday Jan 10<sup>th</sup>, Thursday Jan 18<sup>th</sup>, Friday Jan 26<sup>th</sup>

1900 GMT to 2359 GMT each session.

Fast Scan TV all Bands

Three best logs out of four to be entered.

## Members adverts

Non trade advertisements are placed in this column free of charge to paid up members only. Please quote your membership number. Copy should be sent to:-

CQ-TV Editor, 14 Lilac Avenue, Leicester, LE5 1FN, England.

**E-mail:** [editor@batc.org.uk](mailto:editor@batc.org.uk)

## For Sale

Fujinon TV Zoom lens type C14x25MD3 I don't know what the C14 bit is, but the lens is a 25 to 1 zoom, with motorised focus, iris and zoom functions. A mains operated control box with piano key type controls and variable speed zoom is included. The diameter of the first lens is about 3 inches and the camera end is C-mount. This lens would be just great mounted on a repeater tower or on top of an OB van. £75.00 *call Dave Webb on 01159 161 432*

Panasonic camcorder NVM10B, full size with hard case, battery, PSU/charger, RF adapter, auto/manual focus zoom, and stereo sound. A/V out, insert edit, audio dub, and high-speed shutter. £220.

Mitsubishi HS710B portable video cassette recorder with carry case, direct camera connection, A/V in/out, mic in, audio dub, insert edit, tuner, timer. £110. *Contact Brian Bambury on 01386 830863 (Evesham)*

THE BBC TELEVISION CENTRE. BBC 1960. Special illustrated book describing the TV Centre structure with plenty of technical details and photographs. Rare historic item £12. HERE'S TELEVISION. Kenneth Bailly.

Vox Mundi `1950. History and comment about BBCtv until 1950. Well illustrated. d/w. £8. A GUIDE TO INSTRUCTIONAL TELEVISION. Robert Diamond. McGraw-Hill 1964. Teaching with tv. Loads of camera shots etc. £6. INTRODUCTION TO TELEVISION. A.Folwell. Chapman & Hall 1948. Nice post-war beginners guide with photos. Tv studios/tvsets. d./w £6. UNDERSTANDING TELEVISION. John Howkins. Sundial Books 1976. Large format, well-illustrated sections including 'Upstairs-Downstairs', ITN, History of Tv etc. £5 GIRL FILM & TELEVISION ANNUAL No1 1957. No d/w. £5. 1st of this attractive series. EAGLE COMICS. from Vol 2 no.17 1951. 200 to choose from. All intact £2.50 each. All VGC. Postage minimum on all items £1.50. *Contact Dicky Howett. 01371 820155, Email: [dicky.howett@btinternet.com](mailto:dicky.howett@btinternet.com)*

### For Disposal

Panasonic AU750 MII broadcast cassette video recorder. This is, or was the "bees knees". Also it has the roller wheel problem so will need fixing. Otherwise they look nice and do the E to E ok. Swap preferred WHY.

Aston 2 character generator with large quantity of font disks, keyboard, 8" disk drive based. Will need some attention to disk drive unit, two spare diskdrives and aston test jig. £50

Systems video 1258 waveform monitor complete but not working for spares £15

Barco 3/37 14" grade One colour monitor will need fixing. Cheap Conrac 20" grade one colour monitor model 6122 Working with circuit. Good high definition pictures. PAL inputs and controls. Well built, heavy. £65.00

Amcor Projection graphics display unit (new, ex demo unit with manuals and remote control. Appears to be a character generator with limited graphics ability, small unit with 5.25" disk drive. £5.00

Vintern 444 pan and tilt head for medium size cameras, very grubby but functional, no pan bars. £25.00 o.n.o.

Box of spare plug in modules for LDK5 camera and filters £15.00

Aston Time Code reader and inserter TD20. Standard time code. Clean 2u rack unit alas no details. Free

Fane 12" loudspeaker. With "Ionofane" tweeter. Teak case. Late 1960 collectable £50 single speaker only.

*Items are collect only. Brian Summers G8GQS QTHR Phone 01276 677879 0797 0417875*

---

## Wanted

---

Any PCBs with reference to the G8CMQ Solent Scientific TX 10mW, 200mW, 1W transmitters. RX boards RC24 converter and the G8CMQ receiver. Synthesiser board and any board relating to G8CMQ. Working, non-working, or half built boards. **Contact G7GNA. Email: [g7gna@zoom.co.uk](mailto:g7gna@zoom.co.uk).**



Wanted – Service manuals for Panasonic WVP/AZE/B camera, WV/AD36E Genlock unit, WV/VF65 viewfinder, for the WVPF10 unit.

Circuit diagram or info on a Shibarden FP100 camera. **Contact Brian Senior, 1 Bedale Close, Coalville, Leics. LE67 3BE. Tel: 01530 810962**



Wanted: Service manual or circuit diagram for a JVC TK-1281 camera. **Contact Allan G3TQA QTHR, phone 01422 246118 or email [g3tqa@qsl.net](mailto:g3tqa@qsl.net)**



TV camera LENSES. REMOTE ZOOM CONTROLS for Canon J13x9B & Schneider Variogon 9-126. Any items considered in any state of repair. Monocular VIEWFINDER for Ikegami 79E. **Contact Dicky Howett**

**01371 820155, email: [dicky.howett@btinternet.com](mailto:dicky.howett@btinternet.com)**



### List of Wanted Cameras

Pye Mk6, EMI 206 EMI 207, any Fernseh Image Othicon

Marconi Image Orthicon Colour Circa 1955 -1965

Philips LDK11, Philips LDK12, Philips LDK13, Philips LDK6

Pye (CBS) PCP 90 minicam

RCA TKP 45, RCA TK76, RCA Hawkeye HC-1

Thompson any early camera

Bosch any early camera especially portables

### Oddments

Small viewfinder for Bosch Fernseh KCR40

Correct Lens for Link 130

Glass viewfinder lens for Marconi MK3

Link 130 lens

Kodak "Ectar" 35mm. Cine lens with screw thread. Fits early RCA & Marconi cameras.

Documentation relating to early cameras, catalogues etc.

Focus servo for Schinder lens 44.02 (LDK14) & cable also Zoom servo extension cable

The mounting rod that fits in the base of a LDK14

Copies of "Marconi Instrumentation" booklets.

**Brian Summers G8GQS QTHR Phone 01276 677879 0797 0417875**



Wanted - Can anyone please help – I am trying to locate a chip that is no longer available. A 7444 Excess 3-bit grey to decimal decoder. Also, any information with regards a display, Philips LTN111R-10 – QJK341H using a SMD chip HD44780A00. Info required, pinouts and/or circuits using this display. Contact L. W. Smith, G7GNA, Tel: 02392 232097, email [g7gna@zoom.co.uk](mailto:g7gna@zoom.co.uk)



---

## Problems in Germany

---

In the past ATV had little support from national amateur radio club and most people treated ATV as 'playing around' but at least they didn't threaten our frequencies. Now, however, at a time when ATV activity is massive, we are under threat. So I say get ready to defend ATV but don't be aggressive with it. Express your viewpoint wherever possible, get more involved

in discussions and make sure everyone understands what ATV is about.

It appears that the packet radio fraternity in Germany want more space and are asking to be allowed to use frequencies on 70cm reserved for ATV and SATV (narrowband ATV). If this goes ahead, it is argued, ATV activity and the development of digital ATV will be harmed by interference.

As I see it, Ian, this is a local dispute within Germany. Of course, if the PR people won and PR activists in other countries made copycat demands (where have I heard this before?), then ATV would be in trouble.

Kindly translated from the original German by Andrew Emmerson.

# GH Engineering

## GH Quad 1.3 GHz 72W solid-state amplifier

The GH <i>Quad</i> is a new design from GH Engineering. It utilises four M57762 PA modules to give up to 72W over the frequency range 1240 – 1300 MHz. Available as a mini-kit, which includes the PCB, PCB mounted components, mounting /drilling template, 2 x PCB mounted SMA sockets and undrilled heatsink. Full instructions and assembly drawings are provided with the kit. The heatsink is available pre-drilled and tapped if required.	Basic mini-kit----- £360 With heatsink pre-drilled and tapped----- £398 Fully built and tested--POA
---	---

Fan kit – optional, but recommended for ATV use. Consists of 2 x 93mm 12V DC axial fans, finger guards and fixings. £12 (Requires extra holes to be drilled and tapped in heatsink – details supplied with kit)

### PA1.3G-2 2Watt amplifier and PA1.3G-18 18Watt amplifier

The PA1.3G-2 uses an M67715 PA module to deliver 2-2.5W output for an input of 10mW. A 7dB attenuator is supplied as standard which will reduce the level from the G1MFG Tx to a safe level. The PA1.3G-18 is similar, but uses an M57762 to deliver and output of 18W for an input power of 0.5 – 1W. Both amplifiers incorporate a solid state PTT switch for the bias supply, reverse polarity protection and an input attenuator. Available either as a mini-kit, full kit or built and tested. The full kit consists of the mini-kit plus an aluminium case, RF, DC and PTT connectors, front panel switches and LEDs and internal connecting leads. N-type connectors are supplied as standard for RF input and output; SMA connectors may be supplied if required

PA1.3G-18 mini-kit	£88	PA 1.3G-2 mini-kit	POA
PA1.3G-18 full kit	£124	Diecast box for PA1.3G-2 (110 x 90 x 50mm)	£3.50
PA1.3G-18 built and tested	POA		

Heatsinks for the PA1.3G-2 and the PA1.3G-18 can be supplied drilled and tapped for an extra £8.

### Mitsubishi Power Amplifier Modules

Note that Mitsubishi have recently announced huge price rises for the entire range of modules – prices can be held only until stocks last. Please check before ordering. GH Engineering can supply products from the entire range of Mitsubishi Semiconductors.

M67715 1240-1300 MHz 1.2W	POA	M57762 1240-1300 MHz 18W	£50
---------------------------	-----	--------------------------	-----

#### Mini-Circuits

ERA-1	£3.50	MAR-1	Equivalent to MSA-0185/0186	£2.00
ERA-4	£5.50	MAR-2	Equivalent to MSA-0285/0286	£2.00
ERA-5	£5.80	MAR-3	Equivalent to MSA-0385/0386	£2.50
SRA-1H	£26.00	MAR-4	Equivalent to MSA-0485/0486	£2.50
TUF-1H	£14.00	MAR-6	Equivalent to MSA-0685/0686	£2.50
MAV11	£3.50	MAR-8	Equivalent to MSA-0885/0886	£2.80

#### RF Transistors

BFR96s	£2.50	BFQ34 replacement for the obsolete BLV91	£10.50
BFR91a	£2.50	MRF581 replacement for the obsolete BLU98	£ 2.00
<b>Voltage regulators</b> 8V, 1.5A for M67715	£0.80	9V, 2A for high power PA modules	£1.00

**RF Connectors** A full range of SMA and N-type connectors for PTFE and Semi-rigid cable is available.

East Cottage  
Chineham Lane  
Sherborne St. John  
Hants RG24 9LR

Tel 01256 869603  
email: - [sales@ghengineering.co.uk](mailto:sales@ghengineering.co.uk)  
more details on web site: - [www.ghengineering.co.uk](http://www.ghengineering.co.uk)

## Index of Advertisers

Amateur Television Quarterly .....	18	HS Publications .....	4
BATC advertising rates .....	18	Members Services .....	25
BATC Publications.....	25	'Repeater' magazine.....	44
Confidential Communications Ltd .....	44	S. Marshall .....	4
CQ-TV contribution deadlines .....	23	Sevenside Television Group .....	4
GH Engineering.....	48	Worthing Video Repeater Group .....	41