

# Contents

Contents ..... 1  
 Committee Contacts ..... 2  
 Chairman’s Column..... 3  
 Enigma Rally..... 4  
 Subscription rates ..... 7  
 CQ-TV Commercial advertising rates ..... 7  
 Deadline..... 8  
 TM531 - A Packet of interference? ..... 8  
 A Little Spot of Invention..... 10  
 Digital Video - Questions and Answers – part 1 ..... 11  
 New Digital Test Card ..... 13  
 Core decodes and displays up to eight MPEG2 streams ..... 14  
 ATVISS – Amateur Television on the International Space Station ..... 15  
 Digital television in the USA ..... 16  
 Digital Amateur TV tests started in Germany ..... 17  
 Members’ Services ..... 18  
 BATC Publications ..... 19  
 An introduction to PIC programming. Part 2 ..... 20  
 Members only! ..... 24  
 Call sign generator ..... 24  
 Further uses of Plug Top Power Supplies ..... 25  
 Profiling RF Parabolae..... 28  
 Circuit Notebook 70 ..... 29  
 TV on the air ..... 30  
 In Retrospect ..... 33  
 Satellite TV News..... 34  
 TANDATA Videotex Terminals - RAM Upgrade ..... 39  
 24cms Filter Experiment ..... 41  
 Television Repeater in Trouble..... 44  
 Digital TV deal for Zoran and Infineon ..... 44  
 Post and News ..... 45  
 Members adverts ..... 47  
 For Sale..... 47  
 Wanted..... 48  
 Index of Advertisers..... 48

Edited by Ian Pawson, circuits drawn by Allan Robinson, proof read by Peter Delaney. All rights reserved, all wrongs denied.

Copyright © 2000 by the BATC and contributors.

### Legal Niceties (the small print)

E&OE. Whilst every care is taken in the production of this publication, the editor accepts no legal responsibility for the advice, data and opinions expressed. The BATC neither endorses nor is it responsible for the content of advertisements or the activities of those advertisers. No guarantee of accuracy is implied or given for the material herein. The BATC expressly disclaims all liability to any person in respect of anything and in respect of the consequences of anything done or omitted to be done wholly or partly in reliance upon the whole or any part of this magazine.

The contents of this publication are covered by international copyright and must not be reproduced without permission, although an exception is made for not-for-profit publications (only) wishing to reprint short extracts or single articles and then only if acknowledgement is given to CQ-TV.

Apart from any fair dealing for the purposes of published review, private study or research permitted under applicable copyright legislation, no part of this publication may be reproduced, stored in a retrieval system or transmitted in any form or by any means, electronic, mechanical, photocopy, recording or otherwise, without the prior permission of the publisher. All copyrights and trademarks mentioned in this publication are acknowledged and no infringement of the intellectual copyright of others is intended. Printed in Great Britain. ISSN 1466-6790

### Notice to Contributors

Authors are alone responsible for the content of their articles, including factual and legal accuracy, and opinions expressed by them may not reflect the editorial stance of the publication. Material submitted to CQ-TV should not infringe the copyright of other writers or bodies. Articles remain the copyright of their authors and following publication in CQ-TV, they may also appear on the BATC's web site and CD-ROMs, also in other not-for-profit amateur publications. Contributions are accepted for publication on this basis alone.

Printed by Clipper Print Ltd., Unit 13, East Goscote Ind. Estate, East Goscote, Leicester, LE7 3XJ, England. Telephone: 0116 260 9909.

---

## Committee Contacts

---

### **BATC Chairman: Trevor Brown, G8CJS**

Club affairs, Video tape library, Technical queries, especially relating to handbook projects. 14 Stairfoot Close, Adel, Leeds, LS16 8JR. Tel: 01132 670115. E-mail: [chairman@batc.org.uk](mailto:chairman@batc.org.uk)

### **BATC General Secretary: Paul Marshall, G8MJW**

General club correspondence and business. Library queries relating to the borrowing or donation of written material. Fern House, Church Road, Harby, Notts., NG23 7ED. Tel: 01522 703348. Email [secretary@batc.org.uk](mailto:secretary@batc.org.uk)

### **BATC Hon. Treasurer: Brian Summers, G8GQS**

Enquiries regarding club finances, Donations, and constitutional enquiries. 9 Prior Croft Close, Camberley, Surrey, GU15 1DE. Tel: 01276 677879, Mobile: 0797 0417875, Email: [treasurer@batc.org.uk](mailto:treasurer@batc.org.uk)

### **CQ-TV Magazine: Editor Ian Pawson**

Anything for publication in CQ-TV, Articles, Review items, Letters to the editor, and other material except as below. 14 Lilac Avenue, Leicester, LE5 1FN, England. Tel: 0116 276 9425, Email: [editor@cq-tv.com](mailto:editor@cq-tv.com)

**Photographs for the CQ-TV covers:** - Please send any photographs by post, electronic images by email, to the editor at the above addresses.

**TV on the Air:** - Graham Hankins G8EMX, 11 Cottesbrook Road, Acocks Green, Birmingham, B27 6LE. Tel: 0121 707 4337

**Satellite TV News:** - Paul Holland G3TZO, Chatterton, Chapel Lane, Threapwood, Nr. Malpas, Cheshire, SY14 7AX. Tel: 01948 770429, Email: [satnews@batc.org.uk](mailto:satnews@batc.org.uk)

**CQ-TV Advertising Manager:** - Trevor Brown, 14 Stairfoot Close, Adel, Leeds, LS16 8JR. Tel: 01132 670115. Email: [adman@batc.org.uk](mailto:adman@batc.org.uk) Members adverts for inclusion in CQ-TV should be sent directly to the editor and the above address, either by post or e-mail.

**CQ-TV Awards:** - Bob Webb G8VBA, 78 Station Road, Rolleston on Dove, Burton on Trent, Staffs., DE13 9AB. Tel: 01283 814582

### **Exhibitions**

Graham Hankins G8EMX, 17 Cottesbrook Road, Acocks Green, Birmingham, B27 6LE. Tel: 0121 706 7384 Email: [exhibitions@batc.org.uk](mailto:exhibitions@batc.org.uk)

### **Club Sales**

**Members Services:** - PCB's, components, camera tubes, accessories, etc. (NOT PUBLICATIONS). Peter Delaney, G8KZG, 6 East View Close, Wargrave, Berkshire, RG10 8BJ. Tel: 0118 940 3121. Email: [services@batc.org.uk](mailto:services@batc.org.uk)

**Publications:** - Handbooks, Back copies CQ-TV, and anything related to the supply of BATC publications. Paul Marshall, Fern House, Church Road, Harby, Notts., NG23 7ED, England. E-mail: [publications@batc.org.uk](mailto:publications@batc.org.uk)

### **Membership**

Anything to do with membership, including new applications, queries about new and existing membership, non-receipt of CQ-TV, subscriptions, membership records, data protection act. Dave Lawton, G0ANO, 'Grenehurst', Pinewood Road, High Wycombe, Bucks., HP12 4DD. Tel: 01494 528899. E-mail: [memsec@batc.org.uk](mailto:memsec@batc.org.uk)

**Club Liaison:** - And anything of a political nature, co-ordination of ATV repeater licences. Graham Shirville, G3VZV, The Hill Farm, Potsgrove, Milton Keynes, Bucks., MK17 9HF. Tel: 01525 290343. E-mail [g3vzv@amsat.org](mailto:g3vzv@amsat.org)

**Contests:-** Richard Guttridge, G4YTV, Ivy House, Rise Road, Skirlaugh, Hull, HU11 5BH. Tel: 01964 562498

### **CQ-TV and BATC web masters**

Anything to do with the CQ-TV web site Email: [webmaster@cq-tv.com](mailto:webmaster@cq-tv.com) or for the BATCs web site. E-mail: [webmaster@batc.org.uk](mailto:webmaster@batc.org.uk)

## Chairman's Column

It's now approaching the time of year when we hold the BATC rally, which for the last three years has been at the Sky Blue connection and managed by Mike Wooding. Last year the expensive venue resulted in a deficit on club funds. These events are hard work for not only the organiser, but all those who turn up the night before to put tables and power in place, organise the car parking the following day and stay behind to clear up and stack the tables afterwards. To stand back at the end of all this and realise that you are several hundred pounds down on your days work is not the warmest of feelings.

This year we decided not to hold a rally and put the money to better use. Dave McQue came up with a new plan, starting with a new smaller venue, Bletchley Park, at was one-tenth the cost of Sky Blue. For those of you who have never seen this venue, and that includes me, I suggest you visit their website [www.bletchleypark.co.uk](http://www.bletchleypark.co.uk). Bletchley Park has a very interesting past in that during the Second World War, it was known as Station X and ran a very successful code breaking operation including the famous ENIGMA code. For those of you that have not seen the recent television programmes on the subject, the ENIGMA machine was a mechanical device into which messages were keyed and the coded output could be set to one of hundreds of different combinations depending on the mechanical settings. The one weakness was that what ever letter was keyed in, it never came out as that letter, so by looking for frequently used phrases and checking none of the letters matched a key or crib, as it was called, could be generated and used to break the code. Large mechanical and later electronic (thermionic valves) machines speeded up the process. The problem was how to use the intelligence without letting the enemy know that their code had been broken. At the end of the war the machines were destroyed, but much work has been done on re-creating these interesting machines. Dave has arranged for visitors to the rally to tour this interesting building for a small fee. The rest of the rally is still being worked on at the time of going to press, so I hope the usual sideshow of OB trucks and possibly even another

satellite up-link may be possible. I hope you will all turn up and support Dave - I know how much work goes into one of these events.

[www.cq-tv.com](http://www.cq-tv.com) is now registered to BATC. We have used CQTV as the name for our flag ship magazine from the outset and it would be a pity to not have the website domain registration to accompany it. [www.cqtv.com](http://www.cqtv.com) has already been snapped up, and we have a growing TV viewer's pressure group called "The Campaign for Quality Television" who are fond of calling themselves CQTV. Within days of the site registration coming through Ian had it up and running and linked into [www.batc.org.uk](http://www.batc.org.uk), our other site, and it has already attracted several hundred visitors.

Thank you all for all the suggestions of whom you would like to see as the new BATC President. The committee discussed these at their last meeting and hopefully we will have an announcement for you in the next magazine.

There were no suggestions on how we get the pre CQ-TV 173 magazines onto the club CD. At the moment they exist as paper copies only, on the club bookcase in Paul Marshall's living room. If we can get them onto CD ROM, they can be made available to all the members and be preserved in a more durable format that was not even conceived when Mike Barlow wrote

CQ-TV number one. While on the subject of Paul Marshall's living room, the mailing of CQ-TV has moved to Brian Kelly's living room. This operation of putting the magazine into envelopes and sorting it into press-stream order is a difficult task and I feel we owe Jill and Paul Marshall a vote of thanks for their past efforts as we do Mike Wooding who did the task before them. Brian is facing a baptism of fire, as we need to get this magazine printed and on your doorstep before 7 May, when the rally takes place in order to publicise it. The projected date for your doormat is April 27 so did we make it? While on the subject of dates, yes, I know that we clash with the Drayton Manor rally and that this is a favourite with many of you. Sorry, even BATC organisation is fallible. Please give us your support - a lot of midnight oil is being burnt on the event.

Last but not least, I have just heard from Rob Ulrich who produces the Dutch ATV magazine "Repeater", that he is hoping to switch to an English and Dutch language format. This is an excellent ATV magazine and full of ATV projects - many of which have been reprinted in CQ-TV. I hope many of you will subscribe to this new version, when it becomes available, while continuing your subscription to CQ-TV, of course.

**Trevor Brown, BATC Chairman**  
email: [Chairman@batc.org.uk](mailto:Chairman@batc.org.uk)



# **The BATC ENIGMA CONVENTION and ANNUAL RALLY will be held in Historic BLETCHLEY PARK on Sunday the 7th of May 2000**

**The Gate will open for visitors from 10.00 hrs. Entry fee £1 per person-accompanied children under 16 free.**

**Talk in on S22 by the Milton Keynes ARS that is based in the Park.**

**All indoors in the former CAA building, with two separate rooms for members to display their personal equipment and discuss developments Although it is a “Closed weekend” for the museum a special tour of the Cryptology trail will be available during the afternoon for an additional £1 payable at the entrance to the trail in Faulkner House.**

**Refreshments are available both indoors, in Faulkner house, and outdoors, with a Bar in Hut 4**

**A member’s car boot sale at £5 per pitch is set out on the Faulkner House car park- NO VANS.**

**Visitors will be free to visit GB2BP and some other specialist groups in Faulkner House who have kindly agreed to open up for the occasion. The Military Group will provide generator power for any OB vans.**

**Members wishing to attend a social evening in the bar on the Saturday are advised to contact Tom G3LMX for a list of local establishments, SAE please! A buffet at £5 has been arranged early booking essential.**

**Red Cross in attendance, Cadet forces as guides.**

**Maps of the site and travel information are shown on the following pages.**

**All maps and information reproduced by kind permission of The Bletchley Park Trust.**

## Where is Bletchley Park?

Bletchley Park is 200 yards to Bletchley railway station in Milton Keynes, Buckinghamshire. It is located just off the B4034, Bletchley to Buckingham road.

## Opening times

Bletchley Park is open every other weekend 10:30am to 5:00pm with last admissions at 3:30pm, and the last tour begins at 3:00pm. For further details of open weekends and special events, visit the [Bletchley Park Open Weekend Diary Page](#).

## Parking and Wheel Chair Access

Parking is free within the grounds of the Bletchley Park. Bletchley Park has good wheel chair access.

## Refreshments

There are 3 refreshment areas, offering a good selection of hot and cold food. Groups of 20 or more are welcome to telephone +44 (0) 1908 640404 if they want to make special arrangements.

## Visiting Bletchley Park by Public Transport

### By Rail

Fast efficient service to Bletchley Railway Station from:

London Euston, Milton Keynes Central (for InterCity connections), Coventry and Birmingham New Street.

Bedford Midland (except Sunday) for connections to London Thames Link, East Midlands and South Yorkshire. For more information, including train times visit the [Railtrack web site](#).

### By Bus

There are buses and coaches from all parts of Milton Keynes and beyond, arriving at Bletchley Bus Station. On leaving the Bus Station head towards the Railway Station and take the footpath to Bletchley Park, opposite the station entrance.

## Visiting Bletchley Park by Road

### From the North or East

Find Saxon Street (V7, also marked B4034) and South towards Bletchley. Follow the signs towards Bletchley Railway Station. Go straight across the double roundabout into Buckingham Road (B4034). At the Eight Belles public house turn right into Church Green Road then take the first right into Wilton Avenue that leads into the Park.



Road map of Milton Keynes

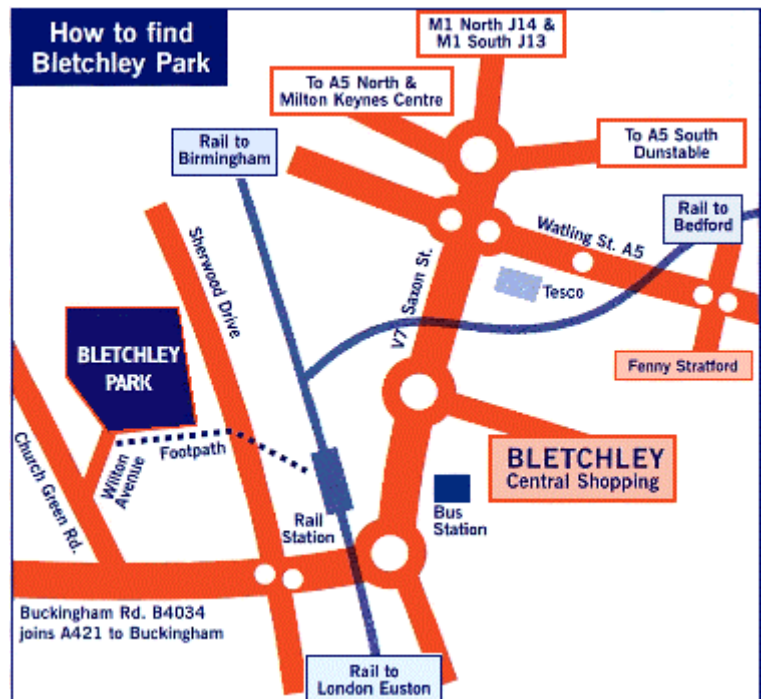

Road map of Bletchley

**From the West**

On the A421 look for the roundabout with the B4034 to Bletchley on the right, then look for the Eight Belles public house on the left.

**From the South West**

Enter Bletchley on the A4146, and follow the signs for Bletchley Railway Station. At the double roundabout on Buckingham Road turn left.

**From the South**

Enter Bletchley on the old A5 (V4) through Fenny Stratford, turn left at the Tesco store onto the B4034.

**A map of Bletchley Park**

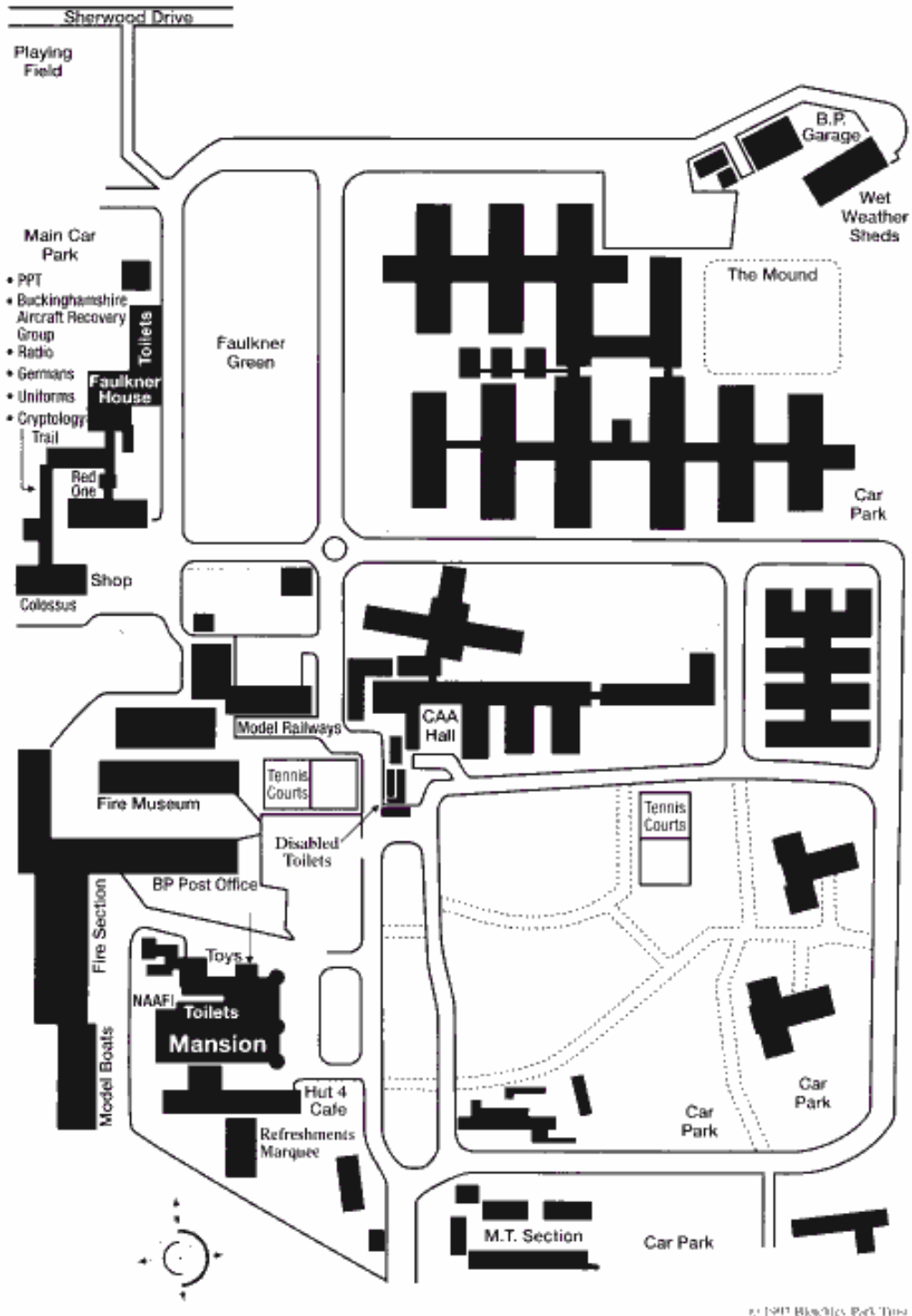



## Subscription rates

### By the Membership Secretary

The subscription rates to the BATC for the year 2000 are shown below. This is the first price rise in many years but, with the continuing rising costs of production, printing and postage, a price rise was inevitable.

However we hope you will agree that we have continued to improve the magazine with the change to the A4 format and use of colour within the magazine and agree with us when we say that this still represents excellent

value for money. I quote from the VHF/UHF column in The Radio Society of Great Britain's journal, "As ever, this 60 page magazine is one of the finest amateur publications you are likely to find".

Years	Surface	Airmail
One	£15.00	£21.00
Two	£29.00	£41.00
Three	£43.00	£61.00

Please note that the 'Surface' rate cover postage within the EEC.

We have also continued to improve our web site at [www.batc.org.uk](http://www.batc.org.uk) and this has proved to be very popular and is now attracting many new members.

If your subscription is due shortly you will find a renewal letter enclosed with this magazine.

You hope you will continue to support the Club and we look forward to receiving your renewal.

## CQ-TV Commercial advertising rates



Size	Mono	Colour
Quarter page	£20	£25
Half page	£40	£50
Full page	£80	£100

Discounts of 5% for 2-3 insertions and 10% for 4 and above apply to the above prices.

If you would like to advertise in CQ-TV, then please contact our advertising manager, Trevor Brown, 14 Stairfoot Close, Adel, Leeds, LS16 8JR. Tel: 01132 670115. Email: [adman@batc.org.uk](mailto:adman@batc.org.uk)



## Free Internet Dial-Up Accounts for BATC members

Caladan Communications, a UK based Internet Services Provider are pleased to be able to offer BATC members free dial-up access to internet e-mail and news services. Contact Chris Smith (G1FEF) for more details:

E-mail: [sales@caladan.co.uk](mailto:sales@caladan.co.uk) Fax: 01933 666972, Web site: <http://www.caladan.co.uk/batc>

Or write to: 'Free BATC offer' Caladan Communications 25 Dando Close, Wollaston, Northants, NN29 7QB

---

## Deadline

---

CQ-TV is published quarterly in February, May, August and November each year. The deadlines for each issue are as follows: -

*February - 20<sup>th</sup> December, May - 20<sup>th</sup> March, August - 20<sup>th</sup> June, November - 20<sup>th</sup> September.*

Please send your contributions in as soon as you can **prior** to this date.

Will all prospective contributors please be sure to read the 'Notice to Contributors' on page 1 so that you understand the implications of submitting an article for publication.

The CQ-TV A4 size Word 97/2000 document template can be downloaded from our web site. Select the CQ-TV magazine link from the home page at <http://www.batc.org.uk>

Commercial adverts should be sent to Trevor Brown, the advertising manager, at 14 Stairfoot Close, Adel, Leeds, LS16 8JR. Tel: 01132 670115. Email: [adman@batc.org.uk](mailto:adman@batc.org.uk)

Members' sales and wants should be sent to the Editor. Email: [editor@cq-tv.com](mailto:editor@cq-tv.com)

---

## TM531 - A Packet of interference?

---

**By Geoff Mather G8DHE**

Email: [geoff@g8dhe.cix.co.uk](mailto:geoff@g8dhe.cix.co.uk)

For the last few months GB3VR on the South coast has been suffering from an interference problem. On a regular basis a flash would occur lasting a few milliseconds, spaced several seconds apart. Only the repeater receiver appeared to be affected, nobody else even in the locality of the repeater was able to spot anything. The assumption was drawn that the problem was local to the repeater and possibly caused by a mains transient on the site itself finding its way into the video path.

However early in February a local user of the repeater located very close to the repeater made some alterations to his aerials, and promptly started to suffer with his 6MHz sound IF being blocked for a few seconds at a time. The duration of the blocking pointed towards a packet signal being the cause. Whilst diagnosing the problem with several members of the group on air listening to the affects it was noticed that the interference that the repeater was suffering coincided with the end of the transmission causing the blocking!

A scan of the local 23cms packet channel rapidly identified the transmission and its source – a node in the local DXCluster network. The aerials of one link at this node were pointing on a path almost directly in line with the repeater, but why the

problem only occurred at the end of the transmission was, initially, less than clear.

Having now identified the problem as being a received RF problem some digging around with the scope to look at the pulse in detail seemed called for. The pulse was in fact a nice triangular waveform going from above peak white to well beyond the sync tip. Clearly the offending signal was sweeping through the bandwidth of the receiver. But how and why would a narrow band FM rig on 1299MHz be generating a rather sizeable signal down at 1249MHz some 50Mhz away. Still 50MHz started to click a few bells, after all it's a common IF frequency? A quick check with the sysop of the Node and the offending rig a Kenwood TM531 was rapidly identified as the cause. Its IF was found to be 59.75MHz, and the cause of the problem was rapidly put down to the fact that the Tx signal source and Rx LO were generated from a single PLL that switched from the output frequency on Tx down to the LO frequency on Rx. This change was obviously taking place before the entire Tx strip was disabled and the aerial changover switching had occurred. The DXCluster group had the rig tested on an analyser and virtually a full 10watts of power was being generated as the signal swept down the entire band (and just outside!) before switching of the transmit path and aerial occurred.

This fault also appears to occur on other copies of the rig in an identical manner, and on other makes of rig, although not to the same level of output which use a similar setup.

The DXCluster group adding a 10-pole filter has mitigated the problem for now, however a cure to the real cause of the problem is still being sought. It would appear to lie in the timing of the switching paths in the rig and seems to affect at least two rigs in an identical manner. The question that now needs to be answered is, is this common to all TM531's, or is it an affect of age (perhaps an electrolytic drying out?).

If anyone has experience of these rigs, or knows of a similar type of problem we would be most interested to hear from them. In the meantime the DXCluster group are making enquiries with Kenwood as to any known problems.

Finally if your repeater or simplex channel is suffering a problem of this nature it might be worth taking a listen to the local packet channels whilst watching your screens, that flash of white might not be all it seems!

Further info about GB3VR and this problem can be found on the Web at the groups site :- <http://www.videorepeater.co.uk/>

---



# GB3XT Kits and Bits

Bob Platts  
43 Ironwalls Lane  
Tutbury  
Staffordshire  
England



01283 813392



**3cms LNB. 0.7db noise figure, 9.0GHz local oscillator.**

**New price now only £35**

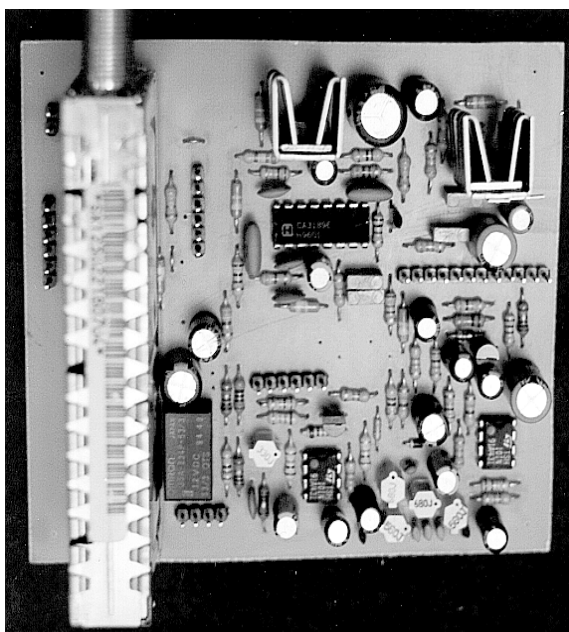

- The very popular Dove RX / IF kit.
- FM ATV Receiver or IF unit.
- 12vDC operation.
- Covers 925 – 1700MHz
- 6MHz (5.5, 6.5 available) intercarrier sound.
- Composite video output plus audio output to drive a loudspeaker.
- Baseband output. Pre-scalar output.
- Very simple to construct. No setting up or alignment required.

**Only £42**

**Note: For 24cms a preamp is recommended.**

*Look out in a future issue of CQ-TV for the synthesiser article for this kit.*

## **Gunmod2. The best selling Gunn diode or DRO Modulator.**

- 5.5, 6.0 or 6.5MHz sound (state). Fully adjustable for video & audio deviation, output voltage & subcarrier.
- 12v DC supply.
- Easy to assemble and set up.

**Only £20**

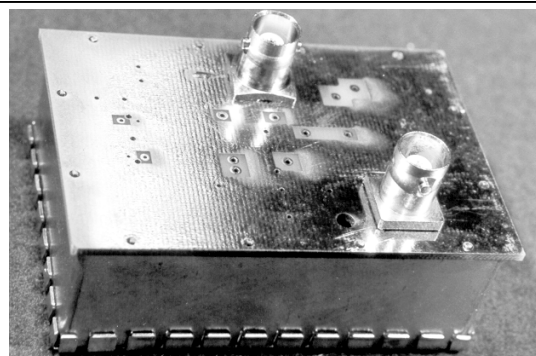
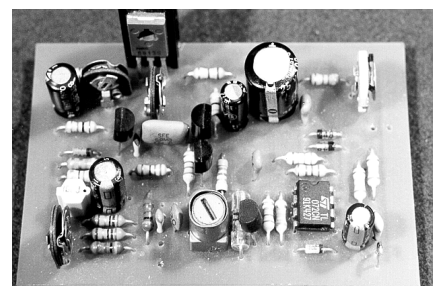

## **24cms pre amp.**

- 40db gain 1db noise figure.
- Strong tin-plate enclosure.
- Quality BNC connectors.
- 12 – 20vDC supply via co-ax.
- Idea for use with satellite RX's or Dove kit.

**£60 kit, £70 assembled and tested.**

**All prices include postage and packing. Cheque with order please.**

---

## A Little Spot of Invention

---

**Dicky Howett** finds fault (again).

Oh dear, and it was going so well, too. I'm referring to a new book about the tragically short life of Alan Dower Blumlein, the genius-inventor of stereo and numerous master audio and TV patents. The book, written by technical author Robert Charles Alexander (all full names are given) is an exhaustive and at times repetitious account of Blumlein's work at EMI and latterly his radar contributions, which ended with his death in 1942 aboard a Halifax bomber, testing the new H2S blind bombing radar system.

All fascinating stuff to be sure. This book will eventually become a prime reference source and here lies the awful problem. There are some glaring factual errors. I'm not competent to comment on any of the technical aspects recalled of neither Alan Blumlein's work nor indeed his family history. I take that all as read. However on page 194 there's an inexplicable and highly erroneous account of the opening of BBC Television's 'high definition' service that took place on the afternoon of Monday 2<sup>nd</sup> Nov. 1936.

I'll forgive the mistake of captioning two photographs of Jasmine Bligh and Elizabeth Cowell (page 192 & 193) where Miss Bligh is Miss Cowell and Miss Cowell is Miss Bligh. Obviously a production error. Where things get very misleading is when Robert Charles Alexander misinterprets totally, the opening of the BBC's electronic television service and jumbles completely the proceedings. Unforgivably careless. For example, he begins by confusing Baird's Studio B at Alexandra Palace and calls it the Spotlight Studio, which was in fact a small annex to the main production area. Of the opening programme, Robert Alexander relates,

"At Alexandra Palace, all the last minute preparations were taking place; explanatory notes were typed up by D.R. Munro, BBC Television

Productions Manager on 30 October 1936, and the entire event was rehearsed on Saturday morning, 30<sup>th</sup> October (without the dignitaries in attendance of course, and the artists were not made up). The rehearsals went well, and everything was set for the following Monday. Three camera positions were used for both the Baird Television system and the Marconi-EMI system. For the Baird transmission Camera No.1, which was the Electron camera, was placed directly in front of the table at which the honoured guests would sit and speak; this was operated by Mr Truck and Mr Bliss. Camera No.2, operated by Mr Wright, was for announcements. Camera No.3 was a reserve, fitted with a telephoto lens, and was operated by Mr Tong".

That account is mystifying. A reading of the programme-as-broadcast script (which I have in front of me) reveals the mistakes. As is well known the final transmission arrangements were altered at the last minute to allow both tv systems (Marconi-EMI and Baird) to be used. The *whole* first week was supposed to be on the Baird system, but as was obvious, Baird's equipment was unpredictable and not exactly 'high definition', (240 lines non-interlaced) and still relied as it did on outmoded Nipkow discs, 'instant' film and photo cells. The published programme in Radio Times for that week in 1936 is no guide at all. For example, the billed Chinese jugglers, The Lai Founs were dropped to accommodate the revised schedule.

At a previously tossed coin the Baird System was, at 3pm first to commence with an announcement by Leslie Mitchell from the small spotlight studio. Approximately forty five seconds later in Baird Studio B the Intermediate Film camera was cued. Two minutes later the vision was switched to the intermediate film system, which had already begun recording the opening speeches. Robert Alexander makes no mention of this intermediate film system in his book. This is curious. Why, also does Robert

Alexander say that three camera positions were used for *both* the Baird television system and the Marconi-EMI system? And how did the aforementioned "electron camera" get into the act? That would then have totalled FOUR cameras in the studio. As is documented quite clearly, *two* separate studios were used, not combined, as Mr Alexander seems to imagine. Studio A was the Marconi EMI studio with its three electronic cameras, and Studio B, the Baird studio with its 20 minutes of 'almost live' intermediate film, plus the small spotlight studio for announcements positioned near the Baird control room.

As time progresses and the pioneers die, accounts of television's early years are increasingly prone to unfortunate distortions, compounded by unattributed 'fairy tales', political corrections and complete fantasy. In this respect, Robert Alexander's book doesn't much help.

A final hilarious touch. In his book Robert Alexander diligently lists the 'opening programme' technical crew. On camera Three which was a reserve with a telephoto lense we had Mr Tong. Correct. Then on camera Two we had announcements and Mr Wright. Right. As for camera One, well there's Mr Bliss, but who pray is Mr TRUCK? Who wheeled him in? Actually, this refers to the camera DOLLY and not an extra camera chap. Oh dear.

Thus, as listed in the original 1936 running order reproduced below:

### **Cameramen**

No. 1 - Truck - Bliss

No. 2 - Announcements - Wright

No. 3 - Reserve (Telephoto Lens) - Tong.

The Life And Works Of Alan Dower Blumlein. (The Inventor Of Stereo) Robert Charles Alexander. 1999. ISBN 0-240-51577-3. 640 pages illustrated. Focal Press. £29.99

# Digital Video - Questions and Answers – part 1

**By Adam J. Wilt**

DV is an international standard created by a consortium of 10 companies for a consumer digital video format. The companies involved were Matsushita Electric Industrial Corp (Panasonic), Sony Corp, Victor Corporation of Japan (JVC), Philips Electronics, N.V., Sanyo Electric Co. Ltd, Hitachi, Ltd., Sharp Corporation, Thompson Multimedia, Mitsubishi Electric Corporation, and Toshiba Corporation. Since then others have joined up; there are now over 60 companies in the DV consortium. DV, originally known as DVC (Digital Video Cassette), uses a 1/4 inch (6.35mm) metal evaporate tape to record very high quality digital video. The video is sampled at the same rate as D-1, D-5, or Digital Betacam video -- 720 pixels per scanline -- although the colour information is sampled at half the D-1 rate: 4:1:1 in 525-line (NTSC), and 4:2:0 in 625-line (PAL) formats. (See below for a discussion of colour sampling.) The sampled video is compressed using a Discrete Cosine Transform (DCT), the same sort of compression used in motion-JPEG. However, DV's DCT allows for more local optimization (of quantizing tables) within the frame than do JPEG compressors, allowing for higher quality at the nominal 5:1 compression factor than a JPEG frame would show. DV uses intraframe compression: Each compressed frame depends entirely on itself, and not on any data from preceding or following frames. However, it also uses adaptive interfield compression; if the compressor detects little difference between the two interlaced fields of a frame, it will compress them together, freeing up some of the 'bit budget' to allow for higher overall quality. In theory, this means that static areas of images will be more accurately represented than areas with a lot of motion; in practice, this can sometimes be observed as a slight degree of 'blockiness' in the immediate vicinity of moving objects, as discussed below. DV video information is carried in a nominal 25 megabit per second (Mbps) data stream. Once you add in audio, subcode (including timecode), Insert and Track Information (ITI), and error correction, the total data stream come to about 36 Mbps.

What's the difference between DV, DVCAM, and DVCPRO?

Not a lot! The basic video encoding algorithm is the same between all three formats. The VTR sections of the DVCAM DXC-D130 or DVCPRO AJ-D700 cameras will record no better an image than the lowly DV format DCR-VX1000 at less than a quarter of the price (please note: I am not saying that the camera section and lens of the VX1000 are the equals of the high-end pro and broadcast cameras: there are significant quality differences! But the video data recorded in all three formats is essentially identical, though there may be minor differences in the actual codec implementations). A summary of differences (and similarities) is tabled in Technical Details. The consumer-oriented DV uses 10 micron tracks in SP recording mode. Newer camcorders offer an LP mode to increase recording times, but the 6.7 micron tracks make tape interchange problematic on DV machines, and prevents LP tapes from being played in DVCAM or DVCPRO VTRs. Sony's DVCAM professional format increases the track pitch to 15 microns (at the loss of recording time) to improve tape interchange and increase the robustness and reliability of insert editing. Panasonic's DVCPRO increases track pitch and width to 18 microns, and uses a metal particle tape for better durability. DVCPRO also adds a longitudinal analogue audio cue track and a control track to improve editing performance and user-friendliness in linear editing operations

## What about Digital8?

Sony's Digital8 uses DV compression atop the existing Video8/Hi8 technological base. Digital8 records on Video8 or Hi8 tapes, but these run at twice their normal speed and thus hold half the time listed on the label. Digital8 will also play back existing Video8 and Hi8 tapes, even over 1394/i.link, allowing such tapes to be read into NLEs (at least, those for which the lack of timecode is not an issue -- batch capture utilities are unlikely to work, since Video8/Hi8 timecodes are not sent across the 1394 connection). Digital8 is a camcorder-only format as of Spring 1999; no VTRs are expected. It appears to be the

8mm division's way of keeping its customer base from defecting to DV. By taking advantage of the massive investments of 15 years in 8mm analogue camcorders and transports, the unit cost of Digital8 gear is kept very low, roughly half of what a comparable DV camcorder would cost, and its ability to play back legacy analogue tapes is worthwhile for those with large libraries of 8mm. All Digital8 camcorders can record from the analogue inputs (at least outside the EU), and all are equipped with i.LINK ports for digital dubbing and NLE connections.

## How good are the DV formats compared to other formats?

DV formats are typically reckoned to be equal to or slightly better than Betacam SP and MII in terms of picture quality (however, DV holds up better over repeated play cycles, where BetaSP shows noticeable dropout). They are a notch below Digital-S and DVCPRO50, which are themselves a (largely imperceptible) notch below Digital Betacam, D-1, and D-5. They are quite a bit better than 3/4' U-matic, Hi8, and SVHS. On a scale of 1 to 10, where 1 is just barely video and 10 is as good as it gets, I would arrogantly rate assorted formats as follows: D-5 (10-bit uncompressed digital) 10 D-1 (8-bit uncompressed digital) 9.9 Digital Betacam, Ampex DCT 9.7 Digital-S, DVCPRO50 9.6 DV, DVCAM, DVCPRO 9 MII, Betacam SP 8.9 1' Type C 8.7 3/4' SP 6.5 3/4', Hi8, SVHS 5 Video 8, Betamax 4 VHS 3 EIAJ Type 1, Fisher-Price Pixelvision 1 [I had previously placed D-2 and D-3 uncompressed composite digital formats just below BetaSP, lower than any of the component formats. My feeling was that while D-2 and D-3 are excellent first-generation formats for composite analogue playback and NTSC broadcast, the compositing of colour with luminance (which includes a colour bandwidth limitation even more severe than DV or BetaSP employ) makes clean multigeneration and multi-layer image compositing problematic at best (even such simple things as adding titles). However, I was severely rebuked by several people with extensive digital composite experience, who all rated D-2 and D-3

between DV and DigiBeta. If you've got a high-end all-digital post-production chain, the quality in these formats holds up over multiple generations extremely well, much better than any analogue format, be it component or composite. While this is certainly true, if you don't have that all-digital pathway, I'm doubtful about how they would fare... so assume that D-2 and D-3 fall somewhere in the range between 1' and DigiBeta, and go have a look for yourself! I've also moved 1' / BetaSP / DV formats down a bit numerically, though the relative rankings are preserved. Again, people who live in high-end digital suites all day suggested this, and I have to agree. My perceptions are largely predisposed to see BetaSP quality as pretty darned good; most of my work has been in analogue component and Y/C editing with analogue Y/C monitoring on PVM-series monitors. But after you sit in front of analogue component or digital monitoring using BVM or Panasonic broadcast-grade monitors, your attitudes start to adjust upwards, and you start to discern differences between the merely very good stuff and the truly excellent stuff a bit more readily!

### **What are the DV artefacts I keep hearing about?**

DV artefacts come in three flavours: mosquito noise, quilting, and motion blocking. Other picture defects encountered are dropouts and banding (a sign of tape damage or head clogging). The most noticeable spatial artefacts are feathering or mosquito noise around (typically) diagonal fine detail. These are compression-induced errors usually seen around sharp-edged fine text, dense clusters of leaves, and the like; they show up as pixel noise within 8 pixels of the fine detail or edge causing them. The best place to look for them is in fine text superimposed on a non-black background - white on blue seems to show it off best. The magnitude of these errors and their location tends to be such that if you monitor the tape using a composite video connection, the artefacts will be masked by dot-crawl and other composite artefacts. A spatial quilting artefact can also be seen on certain diagonals - typically long, straight edges about 20 degrees off of the horizontal. These are minor discontinuities in the rendering of the

diagonal as it passes from one DCT block to the next; so minor that they're usually invisible. Watching such diagonals during slow pans is often the only way to see the artefact. Motion blocking occurs when the two fields in a frame (or portions of the two fields) are too different for the DVC codec to compress them together. 'Bit budget' must be expended on compressing them separately, and as a result some fine detail is lost, showing up as a slight blockiness or coarseness of the image when compared to the same scene with no motion. Motion blocking is best observed in a lockdown shot of a static scene through which objects are moving: in the immediate vicinity of the moving object (say, a car driving through the scene), some loss of detail is seen. This loss of detail travels with the object, always bounded by DCT block boundaries. However, motion blur in the scene usually masks most of this artefact, making this sort of blocking hard to see in most circumstances. Finally, banding or striping of the image occurs when one head of the two on the head drum is clogged or otherwise unable to recover data. The image will show 12 horizontal bands (10 in non-PAL countries), with every other band showing a 'live' picture and the alternate bands showing a freeze frame of a previous image or of no image at all (or, at least in the case of the JVC GR-DV1u, a black-and-white chequerboard, with which the frame buffers appear to be initialized). Most often this is due to a head clog, and cleaning the heads using a standard manufacturer's head cleaning tape is all that is required. It can also be caused by tape damage, or by a defective tape. If head cleaning and changing the tape used don't solve it, you may have a dead head or head preamp, and so a service will be required.

### **What are Digital-S and DVCPRO50?**

JVC's Digital-S (SMPTE designation D-9) and Panasonic's DVCPRO50 use two DV codecs in parallel. The tape data rate is doubled to 50 Mbps (video) and the compression work is split between the two codecs. The result is a 4:2:2 image compressed about 3.3:1. It is visually lossless and utterly gorgeous. Think of Digital Betacam at a bargain price. JVC's Digital-S uses the 1/2' SVHS form factor for tapes

and VTRs, although the tape cassette itself is more robust and the transport is equipped with sapphire guide roller flanges and tape cleaner blades and a new head drum design. One of the Digital-S players will also play back analogue SVHS tapes, allowing its use for editing existing libraries of SVHS tapes as well as newer Digital-S footage. Head life (so far, in on-air broadcast usage) is well in excess of 4000 hours; equipment cost is very low (comparable to 25 Mbps DVCAM or DVCPRO) and maintenance expenses are well below those of the Betacam decks that Digital-S is typically displacing. So far only JVC is supporting this format, which has resulted in a less-than-headlong rush by the video community to embrace it. Panasonic's DVCPRO50 uses the same DVCPRO tapes and transports as its 25 Mbps DVCPRO products (there is also a 93-minute DVCPRO50 tape specifically for the AJ-D950A VTR, which Panasonic says should only be used in DVCPRO50 mode. When using standard DVCPRO tapes, the maximum recording time is about 61 minutes since the P123L cassette is being run twice as fast). DVCPRO50 VTRs will also play back DVCPRO tapes. The 900-series DVCPRO50 kit is real jack-of-all-trades stuff. The AJ-D910WA camcorder will record either DVCPRO or DVCPRO50, in either 4:3 or true 16:9 modes. The AJ-D950A VTR will record and play back either DVCPRO or DVCPRO50, and additionally is switchable between 525/59.94 (NTSC) and 625/50 (PAL) formats. The only thing you give up is miniDV cassette playback; even with the adaptor the 950 won't read the tiny tapes. Fortunately the AJ-D940 DVCPRO50 player will play back those miniDV tapes, and offers a wider range of slo-mo speeds in the bargain. Unlike Digital-S, second-sourcing is available from Philips, Hitachi, and Ikegami. The DVCPRO50 kit is also a lot more portable and lightweight than Digital-S. Panasonic also has DVCPRO-form-factor progressive-scan cameras and VTRs that use the 50 Mb/sec data rate to encode a 480-line proscan image.

### **Four codecs for HD?**

Both JVC and Panasonic showed working prototypes of 100 Mbps DV-derived products at NAB '99 for handling HDTV. Both firms gang four

DV codecs together to get the 100 Mbps data stream, while preserving the same equipment form factor and operational methodologies used in the current 50 Mbps products. Panasonic calls their stuff DVCPROHD100, while JVC uses the D-9HD moniker, reflecting the SMPTE standard number for their DV50 format. It should be noted that both of these companies are well-placed to serve the growing DTV market whatever image format a

broadcaster selects. Panasonic is selling a switchable 720p/1080i HD-D5 VTR (not based on DV technology), the AJ-HD2700, which has already become the studio standard VTR for the dawn of US DTV. JVC's NAB '98 and '99 displays featured Digital-S variants of most popular ATSC DTV formats -- 480i, 480p/30, 480p/60, 720p, and 1080i.. These two companies will be pushing the edge of the DV envelope for quite some time to come... Sony's

HDCAM format uses compression technology 'derived from DV and with certain similarities', but it is not on the main branch of the DV family tree. Its data rate of 135 Mbps yields beautiful images; it's extremely rare to see a noticeable artefact in an HDCAM picture.

Adapted from an article by Adam J. Wilt. Copyright (c) 1998, 1999

## New Digital Test Card

By Paul Pitts

SW2 is a standard feature of both Snell and Wilcox TPG20 and TPG21 test pattern generators. This example shows a PAL variant, (albeit in mysterious monochrome in this instance, but exactly as received off a Free To Air digital satellite transponder recently) where the 2T duration's are of 200 ns and there is no black level set-up.

The most striking feature of this test

card has to be the animated Fresnel zone plate that orbits, (in an anti-clockwise direction) the centre rectangle with a period of one second.

This picture was derived from a 25 Hz frame grab and shows how the movement during this short time frame has blurred the Fresnel pattern. No sooner had I figured out how to do a 50 Hz field grab than the 'off air' card disappeared, not to be seen by me

since!

Details of the frequency range contained within the zone plate, and indeed all the salient features of test card SW2, can be obtained from the excellent Snell and Wilcox web site and for SW2 in particular at <http://www.snellwilcox.com/internet/library/testchart/body.html> Here you will find six A4 colour pages of detailed description of SW2 and its variants.

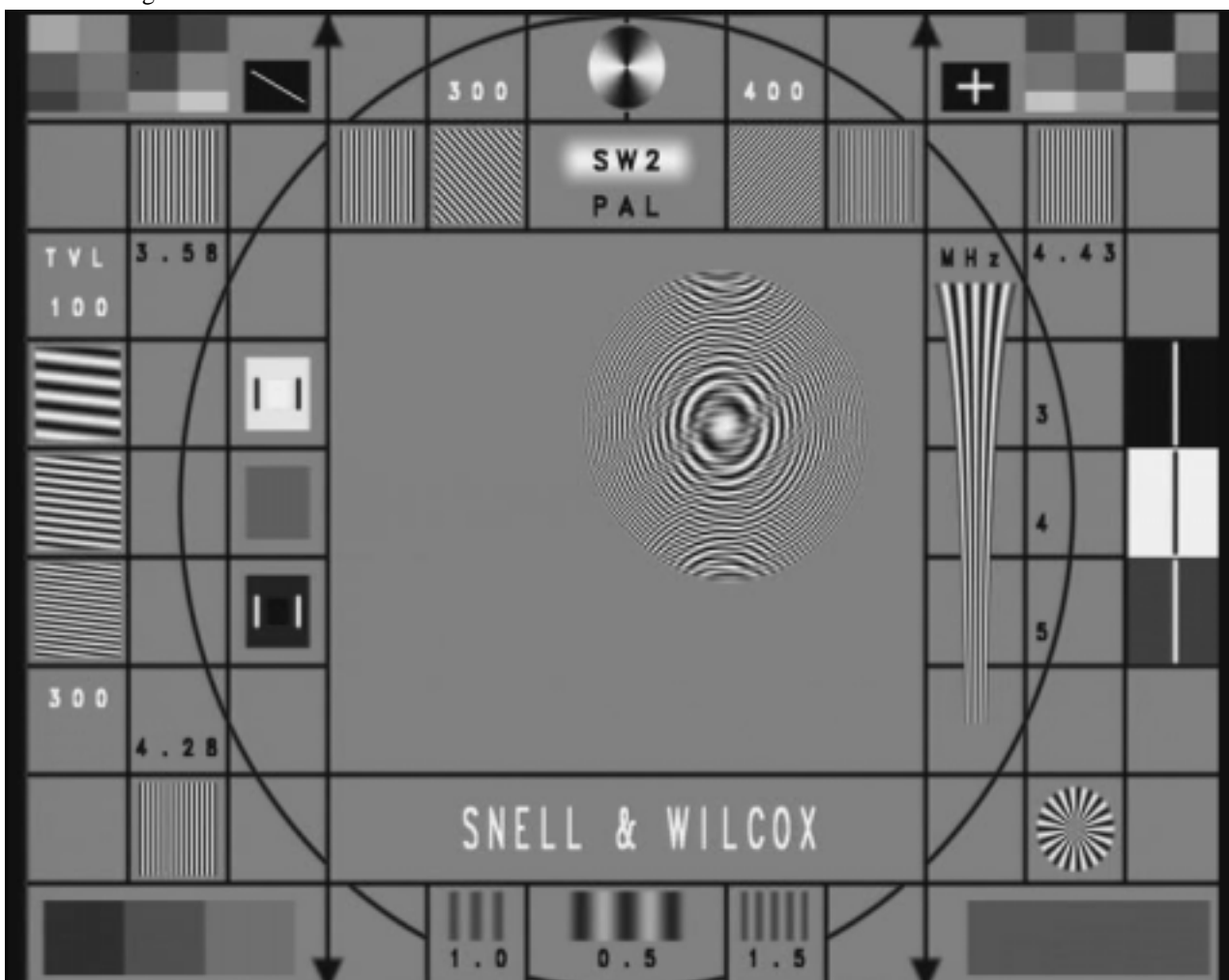



## Core decodes and displays up to eight MPEG2 streams

The first video processor core out of Quintessence Architectures (QuArc) is the Videris-HD. In just 65,000 to 90,000 transistors and less than 2mm<sup>2</sup>, it can decode and display up to eight streams of MPEG2 video on the screen at the same time, running at the full clock speed of 154MHz.

The key to the QuArc approach is based around the idea of 'atoms' and 'molecules' of algorithms as 'objects' in silicon, all linked by a token passing 'bus' and a variable schedule data processing it called data-driven processing.

Each object is a self-contained processing block, which communicates to other objects or customer logic using the token style unidirectional interfaces with request, ready and data signals. The objects can be reused either within the core or in other designs, and avoids the need for complex control logic.

In the data-driven processing architecture, data between the transmitter and receiver objects can be sent at any time, resulting in maximum performance while maintaining full precision decode. The core is designed to distribute worst-case peak processing loads over more cycles, requiring fewer gates and less power.

For each receiver, there is a Request/ready handshake signal pair. The receiver drives the request signal and the transmitter drives the corresponding ready signal and the token bus. Whenever the receiver needs or can accept a data token, it asserts the request.

When the transmitter has a token to deliver, it asserts the ready signal and drives the token bus with the data token. The token is valid only while the ready signal is asserted and is transferred from the transmitter to the receiver on the rising edge of the clock when request and ready are asserted.

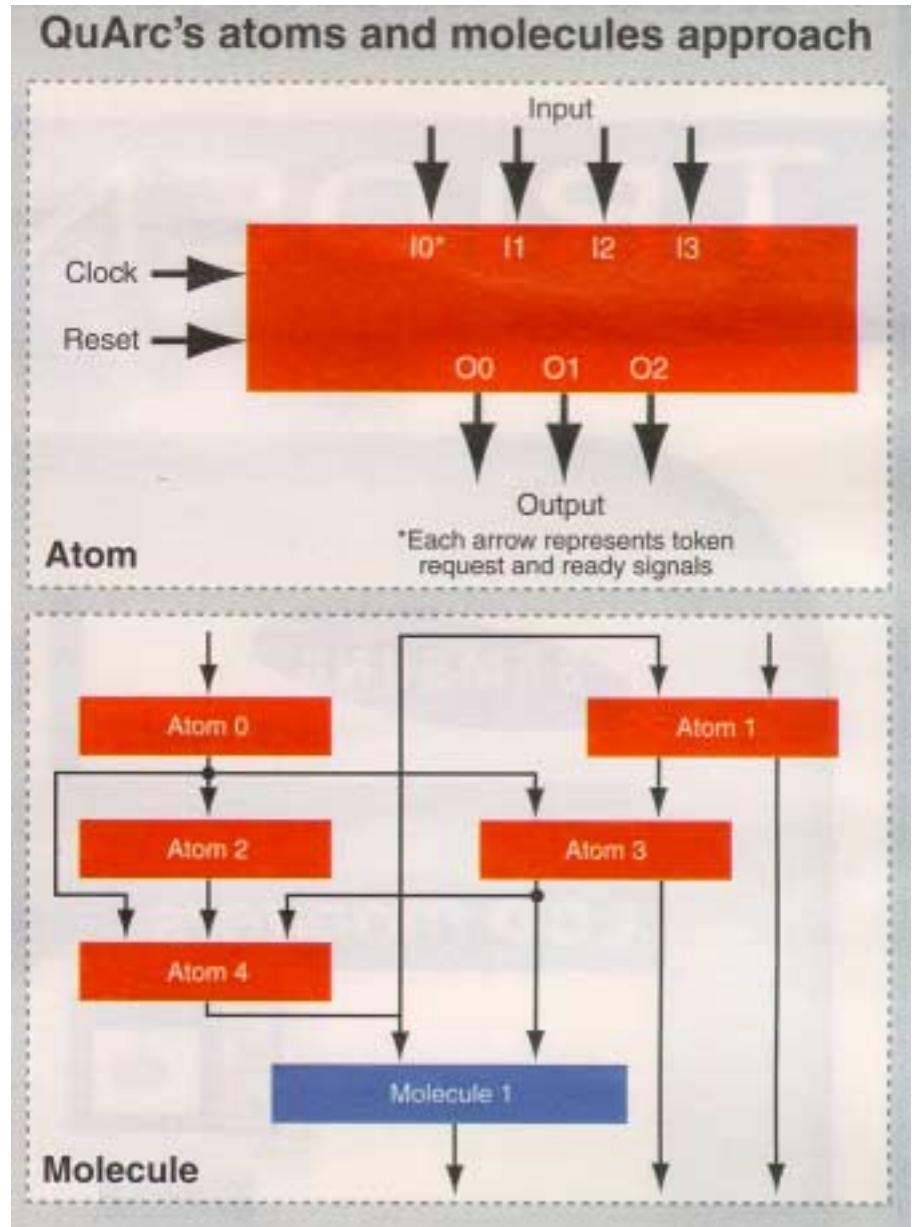

Using this simple protocol means that data tokens can flow on the interface at maximum speed (one token per cycle) and the transmitter and receiver can stall the data transfer in any cycle.

The atom is the smallest object that uses the QuArc token interface, and all atoms have a clearly defined function. The size varies depending on the function's complexity and the processing speed required, but each atom has at least two global signals

(clock and reset) and at least one input and one output interface.

Molecules are collections of interconnected atoms and other molecules. A molecule can be as simple as two atoms or as complex as required to implement a complete system.

*Reprinted from Electronics Times, 6<sup>th</sup> December 1999.*

[www.dotelectronics.com](http://www.dotelectronics.com)

**Visit the new CQ-TV web site at: -**

[www.cq-tv.com](http://www.cq-tv.com)



---

# ATVISS – Amateur Television on the International Space Station

---

**By Graham Shirville, G3VZV**

## Intention

To provide hardware for inclusion in the permanent ARISS station to enable ground based users access to and some control of, video cameras on board the space station.

To so design the downlink methodology and modulation system to enable the pictures to be obtained with relatively simple ground equipment.

To provide a system which is designed to be ideal for incorporating into demonstrations of amateur radio to capture the interest of incomers to our world.

To provide a system which cannot sensibly be duplicated or replaced by the Internet!

## Background

Both the Mir space station and a number of SAREX Shuttle missions have demonstrated SSTV (slow scan) Television. The SSTV transmissions from Mir during late '98 and the first part of '99 have created a dramatic increase in the level of interest in the mode and in the amateur space service.

The saying of “a picture is worth a thousand words...” has never been more true than the area of space exploration. The moon landings and the Mars Rover bear ample witness to this.

A large number of Amateur Radio Satellites have already demonstrated taking “still” pictures of the earth from space and these use devices which can also be used for “moving” pictures.

Fast Scan Amateur Television (FSTV) is activity that started in the late 1940's in Europe and the USA and generally uses standard broadcast systems to maintain compatibility. Current there is ATV activity some 20 or 30 countries around the world. This activity centres on the 70cms/23cms/13cms and 3cms bands both with simplex and repeater operation. There are, perhaps, some 300 ATV repeaters around the world.

Although the best FSATV DX record currently stands at some 2000+miles on 70cms and 500+ miles on 3cms, generally ATV contacts are local in nature.

There are number of national ATV societies around the world (BATC in the UK, AGAF in Germany, HBATV in Switzerland etc) and their total membership is probably in excess of 5000 amateurs, perhaps similar to the worldwide membership of the various AMSAT groups?

## Proposal

One, or more, colour cameras would be placed, externally, at suitable locations on the space frame of the station.

The ISS being stabilised, these cameras would be essentially “earth pointing” and therefore generally not vulnerable to exposure to direct sunlight.

The cameras would be capable of pan/tilt and zoom operation.

The camera(s) would be connected, by an umbilical cable, back to a central power supply, control and transmission unit.

The ground station would command the transmission on for a defined time period (say 5 minutes) by sending a simple command (say a DTMF tone). Additional commands would operate the pan/tilt/zoom system as required by the ground operator.

Alternatively a packet system could be devised for control which would also relay the control sequences received and currently active back to the ground. This would enable the ground station to understand what was happening with the system and other ground stations could also see who was currently commanding the camera.

The latter system would also enable the system's “health” to be monitored by telemetry carried on the same carrier.

Maybe the APRS system would be suitable/could be extended to provide this functionality.

When not under ground command the system could beacon every 2 mins for, say, 10secs with camera video or caption.

A limited number of ground based “Control” stations could also upload captions and operating instructions, which could be transmitted as part of a testcard sequence. (This follows established ATV repeater practise)

The camera would, when the station is manned, be under the control of the astronauts on board.

A camera could have a low light level capability to show “night scenes” of both the ISS and the ground, perhaps for light “pollution” measurements.

The “radio” equipment would consist of: Command receiver and decoder – Simple AFSK 1200Bd packet system would sufficient. The uplink could be just below 438MHz if this would avoid the Pave Paws type radars?

Command relay and telemetry transmitter – Would be to the same standard as the receiver and work in simplex mode on the same frequency.

The video could be, perhaps initially, could be colour SSTV as demonstrated by MIR .If a world-wide allocation on 2 metres was available this would be ideal, but failing that, 10 metres (subject to space for the TX antenna) would allow the use of simple, scanner type, receivers.

There is, currently, no adopted standard for digital FSATV. A digital system would be the most appropriate in terms of definition/power budget/spectrum usage. Until such a system is practicable the best system would be FMTV as currently used by TV amateurs for most terrestrial operation above 1GHz. – The transmitted bandwidth would be, perhaps, some 10MHz if analogue or 4/5MHz if digital. The band of choice for this would be 13cms as it is already in common use by ATV operators in many countries. Antenna beamwidth/gain would be an issue.

---

Selection of 525/625 line standards for analogue signals could be by ground control or by onboard GPS positioning data.

## Summary

This concept is based upon the premise that existing and potential amateurs will be “thrilled” by the possibility of

seeing what is happening on and around the ISS and on the earth below.

They would be further interested in the possibility of “commanding” a part of the ISS themselves directly.

Although the pictures could be relayed via the internet, the relatively low height of the ISS would require a large

network of ground stations to provide a reasonable level of service.

There is nothing described above that is beyond current technology and it should therefore be possible for such a system to be created quickly and, relatively, cheaply.

---

## Digital television in the USA

In a surprise move, the Pentagon has come out against the US digital IV (DTV) standard’s vestigial sideband 8-VSB modulation technology.

Along with broadcast owners controlling 240 TV stations across the country, the Pentagon is asking the Federal Communications Commission (FCC) to reconsider allowing broadcasters to use the alternative European transmission system COFDM.

Digital high-definition IV (HDTV) has often been described as the holy grail of broadcasting, and the FCC has scheduled a 10-year transition for the US’S transition to digital HDTV.

US terrestrial broadcasters have opted for ATSC, which uses a single carrier transmission system, 8VSB, designed to push the signal out as far and as strongly as possible. But ATSC is designed for rooftop reception and 8-VSB cannot support mobile reception.

This is a source of some concern to the Pentagon because, in a case of disaster, whether natural or man-made, government broadcasts will need to be received by people on the move. According to the Department of Defence video working group:

“We are concerned about our national capability to employ digital IV broadcast systems to communicate with the public during civil and defence emergencies”.

The Sinclair Broadcasting Group, representing broadcasters, has become so concerned that consumers may not be able to receive DIV signals with current receivers that it has filed a

petition with the FCC demanding that it should consider allowing its members to use COFDM.

The Sinclair petition makes two requests. It asks the FCC to modify its DIV rules to give broadcasters the choice to transmit their digital signals using either COFDM or 8-VSB. Last year, Sinclair compared the reception of COFDM and 8-VSB signals at 40 sites in the Baltimore area. According to its findings, it was very hard to receive a useable DIV signal using 8-VSB and very hard not to receive a useable DTV signal using COFDM.

Two of the big 8-VSB DTV players, the Consumer Electronics Manufacturers Association (CEMA) and the Advanced Television Systems Committee (ATSC), acknowledge that the “Sinclair tests exposed serious problems with the digital equipment currently on the market”, but insist that “future products will be much improved”. These opponents feel that too much time and money has already been invested in 8-VSB to now abruptly “change horses”.

Both companies feel that the ATSC DIV standard was carefully designed to meet the requirements of the DIV broadcast market in the US, “and does so brilliantly”. An executive of ATSC recently commented that “the solution to this problem is [only] months away”.

But Sinclair and a significant number of broadcasters remain unpersuaded. Broadcast owners controlling 240 commercial stations from across the country support Sinclair’s call for a new DIV standard. Other broadcasters have also threatened to lodge petitions with the FCC.

According to the Sinclair petition, use of the COFDM transmission system will provide many advantages to broadcasters as well as to the viewing public. Not only would COFDM permit more reliable reception with simple consumer-grade antennas but, crucially, it would enhance mobile reception of DIV while giving broadcasters flexibility in formatting their DIV programming.

COFDM technology permits broadcasters to vary their data rates from 4 to 24Mbit in contrast to the 8-VSB standard, which limits a broadcaster to one fixed data rate of 19.34Mbit. COFDM’s variable data rate would enable broadcasters to transmit multiple HDTV programming streams. In contrast, 8-VSB broadcasters will be forever limited by its frozen data rate.

Because the COFDM system can provide HDTV using the same 6MHz channels as 8-VSB, the greater capacity for improvement of COFDM technology will likely permit high-quality reception at even higher rates in the future.

Furthermore, the existing user base of approximately 4000 8-VSB receivers should not prevent the FCC from permitting the use of COFDM, says Sinclair. Given the overall size of the US TV market, the number of consumers who have purchased a DIV set represents just four thousandths of 1% of all US IV households.

Sinclair claims that broadcasters and manufacturers would face only minor costs if the FCC allows the use of COFDM, and that costs would be incurred voluntarily since stations can

---

choose to use either 8-VSB or COFDM modulation

ATSC and CEMA argue that broadcasters have already invested more than \$300mn in transmission equipment that uses 8-VSB, and that revision of the DIV modulation standard now would only add cost and delay to the DIV rollout. But the piece of broadcast technology that would have to be replaced to reconfigure a transmitter from 8-VSB to COFDM is a fraction of the total cost.

At present, HDIV take-up in the US has been slow. Advocates of COFDM technology claim that reliable reception through simple antennas and the use of mobile DIV programming streams will be more likely to encourage DIV take-up.

The most likely outcome is that the FCC will allow broadcasters to choose between AISC and COFDM, but it is possible that an act of political back

peddling on the FCC's part could see ATSC triumphant. If that happens, the US runs great fiscal and industrial risks. At the very least, the FCC may have to reconsider its position on the analogue closure date.

### Progressing to digital

Within the next decade, TV broadcasts in the US are scheduled to convert from analogue interlaced NTSC to progressive scanning digital. This could give consumers an additional reason to buy a digital TV as it provides a major improvement in picture quality.

Analogue NTSC uses interlaced scanning to refresh the screen in two top-to-bottom passes, in effect nudging the CRT's phosphor to act as a memory, storing one field while the next one is being scanned.

But interlacing limits image quality, introduces artefacts and constrains visible detail.

As one field is being scanned, the previous field's light intensity fades as the phosphor's light level decays in the milliseconds between refreshes. As the light level of the older field fades, image detail also fades; the result is a loss of resolution.

Progressive scanning provides greater detail and eliminates the line structure appearance of video. And these advantages are achievable with existing CRT display technology.

All that is required is a deflection yoke capable of 31.5kHz horizontal sweep and the electronics to up-convert from interlace to progressive. The image quality depends on the performance of the up conversion processing.

*Reprinted from Electronics Times 24<sup>th</sup> January 2000*

[www.dotelectronics.com](http://www.dotelectronics.com)

---

## Digital Amateur TV tests started in Germany

**By Klaus, DL4KCK (AGAF e.V.)**

On 16th of December 1999 about 20 hams from 4 DARC districts gathered at the Telecommunications Institut of "Bergische University" in Wuppertal in order to receive a pilot series of Digital ATV equipment.

After an introduction by Prof. Uwe Kraus, DJ8DW his fellow workers DL1EIN and DJ8VR explained details

of the TX and RX modules and the PC interface card for software control.

Each of the four districts has got the following tested prototypes in working order: 1) one TX with relay switch, 2) one RX, 3) one PC with monitor, 4) one PC interface card, 5) appropriate software.

All devices are in cases without power supply (12 Volt DC). A 10 W PA is built into the TX case, two more RX devices for each district will be

constructed in Wuppertal for field tests afterwards. The whole effort is powered by financial support of DARC headquarter, the four districts, AGAF e.V. and by private donations.

The upcoming test transmissions on 434 MHz in GMSK will carry MPEG-1 video from the PC hard disk, but in a lab of the Wuppertal University a little hardware MPEG-2 coder processed live camera pictures - the next generation of DATV (or digital ham television) in Germany.

---

## UNREPEATABLE CLEARANCE SALE

Stocks of the following printed circuit boards will be available at a special low price of 50 pence per board at the Club Rally on May 7th. The same price, plus postage, applies to any mail orders received quoting this notice up to that date.

Stock numbers 13, 20, 21, 26, 46, 55, 56, 57, 60, 61, 62.

(For details see the Member's Services page in this issue, or the listing on the Club website).

Stocks are very limited on some items, so strictly this is on a 'first come, first served' basis.

If any stock remains of these items after 7th May, it will be disposed of. If you foresee a need for any of these items, BUY NOW, or never again!

# Members' Services

		All prices in UK pounds (£)	Each	P&P	Qty	Total
<b>Camera Tubes, Scan Coils, Bases &amp; Lens Mounts</b>						
3	One inch Vidicon base .....	£1.20	£0.30			
4	2/3 inch Vidicon base .....	£0.80	£0.30			
6	Camera tube (see previous note).....	*	£1.20			
<b>Video and I<sup>2</sup>C Circuit Boards/Components</b>						
7	Sync pulse generator PCB .....	£12.00	£0.43			
12	Teletext pattern PCB** .....	£3.50	£0.43			
13	Greyscale/Colour bar generator PCB.....	£3.50	£0.43			
19	Video filter PCB .....	£1.20	£0.30			
20	Video processing amplifier** .....	£4.70	£0.43			
21	Vision switcher matrix** .....	£4.70	£0.43			
26	Video level indicator PCB .....	£5.90	£0.43			
40	I <sup>2</sup> C CPU PCB.....	£10.00	£0.43			
41	I <sup>2</sup> C VDU PCB.....	£10.00	£0.43			
42	13.875 MHz crystal .....	£4.70	£0.30			
70	6.0 MHz Teletext crystal .....	£1.75	£0.30			
43	SAA5231 genlock IC.....	£8.80	£0.30			
44	SAA5243PE Teletext IC.....	£14.70	£0.30			
45	PCF8583 Clock IC.....	£7.00	£0.30			
39	LM1881N Sync separator IC.....	£3.50	£0.30			
81	I <sup>2</sup> C 27256 EPROM .....	£9.70	£0.30			
38	PCF8574P Input expander IC.....	£4.70	£0.30			
10	I <sup>2</sup> C Relay PCB .....	£6.50	£0.43			
9	PCF8574A Input expander IC .....	£4.70	£0.43			
<b>RX, TX and SSTV PCB's and General Components</b>						
47	70cm up converter PCB.....	£13.50	£0.43			
50	108.875 MHz crystal .....	£8.20	£0.30			
86	24cm solid-state amplifier PCB.....	£10.50	£0.43			
55.	Gunn diode modulator PCB.....	£3.00	£0.43			
56	10GHz head unit PCB set** .....	£3.00	£0.43			
57	Tunable IF PCB** .....	£3.00	£0.43			
88.	XR215 phase locked loop IC.....	£5.00	£0.30			
60	G4ENA colour etc. SSTV mod PCB set.....	£5.90	£0.43			
61.	G4ENA SSTV transmit mod PCB.....	£7.00	£0.43			
62	G4ENA auxiliary PCB .....	£2.35	£0.30			
37	GX414 Video switch IC .....	£8.80	£0.30			
68	4.433618MHz crystal .....	£3.25	£0.30			
69.	5.0MHz crystal .....	£3.25	£0.30			
46	4 Rail power supply PCB.....	£3.50	£0.43			
<b>Stationery &amp; Station Accessories</b>						
73.	BATC blue diamond clutchpin badge.....	£1.75	£0.30			
74.	BATC cloth badge .....	£4.00	£0.30			
75	BATC equipment label (6) .....	£0.25	£0.30			
76	BATC square windscreen sticker.....	£0.10	£0.30			
78	BATC test card .....	£0.50	£0.43			
79	BATC reporting chart .....	£0.10	£0.43			
Total Goods and Postage - Amount Enclosed						£.....

The indicated **P&P** prices for Members Services are for postage within the UK only. Will members outside the UK please either try to estimate the extra postage required, or write for a quotation. All cheques **MUST** be drawn on a UK bank. (Eurocheques, in £ sterling, are acceptable). Items marked thus: \*\* are available only until present stocks are exhausted.

**Members Services** orders **ONLY** to: **Mr. P. Delaney, 6 East View Close, Wargrave, Berkshire, RG10 8BJ, England.** Tel: 0118 940 3121 (Evenings, Weekends only please). Email: [services@batc.org.uk](mailto:services@batc.org.uk) Items from these lists can **ONLY** be supplied to **CURRENT** members of the BATC. These lists supersede all previous ones

A description of the various PCB's and components can be found in the 'What's What' guide, or on the BATC Internet pages. URL <http://www.batc.org.uk> (A printed copy available on request, if you send a S.A.E.). Components for club projects are not available from Members Services unless contained within these lists. All club crystals are HC18/U (wire ended). To avoid delay and inconvenience, please be careful to include the correct payment with your order – please do **NOT** send stamps or cash. Post and packing costs are for despatch of one item to United Kingdom members.

**Circuit Details can be found as follows:**

**Revised ATV Handbook (vol. 2):** PCB's 21, 22. **An Introduction to ATV:** PCB's 10, 25, 36, 40, 41, 47, 85, 86. **TV for Amateurs:** PCB 19. **Slow Scan TV Explained:** PCB's 59, 60, 61, 62. **Amateur TV Compendium:** PCB's 12, 27, 54, 55, 56, 57. **CQ-TV (Issue No. in brackets):** PCB's 7(174), 13(128), 20(130), 26(142), 58(139). Item 46 is supplied with circuit details, etc

**CAMERA TUBES** A tube guide appears in CQ-TV 149 and 150. Tubes are now difficult to obtain and members requesting information on availability, prices or other types of tubes or equivalents are asked to send a stamped addressed envelope for their reply.

## BATC Publications

<b>Publication</b>	<b>Each</b>	<b>Qty</b>	<b>Total</b>
<b>An Introduction To Amateur Television (225gm)</b> .....	<b>£5.00</b>	.....	.....
The latest handbook full of detailed information on how to set up your ATV station, plus lots of new video and RF construction projects.			
<b>The Amateur TV Compendium (155gm)</b> .....	<b>£3.50</b>	.....	.....
The BATC handbook featuring construction articles on video units, 24cm and 3cm ATV, a Digital Frame Store, and much more.			
<b>The Best of CQ-TV (150gm)</b> .....	<b>£3.50</b>	.....	.....
A compilation of the best construction articles from CQ-TV's 133 to 146			
<b>CQ-TV Back Issues:</b> .....	<b>£1.50</b>	.....	.....
The following issues are still available. Please circle those required: 142, 143, 144, 147, 150, 153, 154, 156, 158 159, 162, 163, 164, 166, 167, 168, 169, 170, 171, 173, 174, 175,176, 177,178, 179, 180, 181. 182, 183, 184, 185, 186			
Special Offer: Any four of the above issues .....	<b>£5.00</b>	.....	.....
187, 188, 189, 190 .....	<b>£2.50</b>	.....	.....
<b>The BATC CD</b> .....	<b>£5.00</b>	.....	.....
Total Goods and Postage - Amount Enclosed.			£.....

The indicated prices for **Publications** include postage within the EEC. Will members outside the EEC please either try to estimate the extra postage required, or write for a quotation.

**Publications** orders *ONLY* to: **BATC Publications, Fern House, Church Road, Harby, Notts., NG23 7ED, England.** Tel: 0152 270 3348 (Evenings/Weekends only). Email: [publications@batc.org.uk](mailto:publications@batc.org.uk). Publications can also be ordered via our web site at [www.batc.org.uk](http://www.batc.org.uk)

Name		Mem No.	
Address			

**PLEASE MAKE CHEQUES PAYABLE TO 'BATC'.**



# An introduction to PIC programming. Part 2

By Brian Kelly

In the first part of this series we got to know the buzzwords and a little about the insides of PIC devices. This time we will look at how a program actually runs and how to set about writing one. If all goes well, you should be able to write and run a very simple program by the end of this issue's article.

Probably the most difficult concept for the complete beginner to grasp is how dumb a microprocessor is. Despite the hype, Internet and videos of Intel technicians in bunny suits, at the end of the day a micro can do absolutely nothing without being given step-by-step instructions. This is equally true for the simplest processor through to the fastest Pentium. Without instructions the chip will sit forever doing nothing even remotely useful. It is the job of the programmer to harness the chip's capabilities and make it perform a meaningful job. In the Middle Ages, when I first started writing programs, every instruction had to be learned, not only for what it did, but also by its numeric value. I have to confess that I can still read Z80 code in hexadecimal but my psychiatrist tells me I'll get over it. Thankfully, these days we have sophisticated tools called assemblers that make life much easier.

So what is a program? Well, it's a set of instructions to complete a task. Let's draw a parallel with a task that we might encounter in everyday life. Suppose you had to tell someone who didn't know your locale how to reach the next town. The objective is simple, just reach there but along the way there will be landmarks, course changes and decisions to be made. Your instructions might say "turn right at the crossroads and pass through the traffic lights"; plain enough if you know where the junction is and the lights are green. In reality your traveller would have to look at every junction until the crossroads are found then decide if it is safe to navigate to the right and after finding the lights, they have to decide if they say stop or go and act accordingly. You and I would use common sense to follow the directions and experience to make the decisions. PICs have neither of these attributes so they need to be

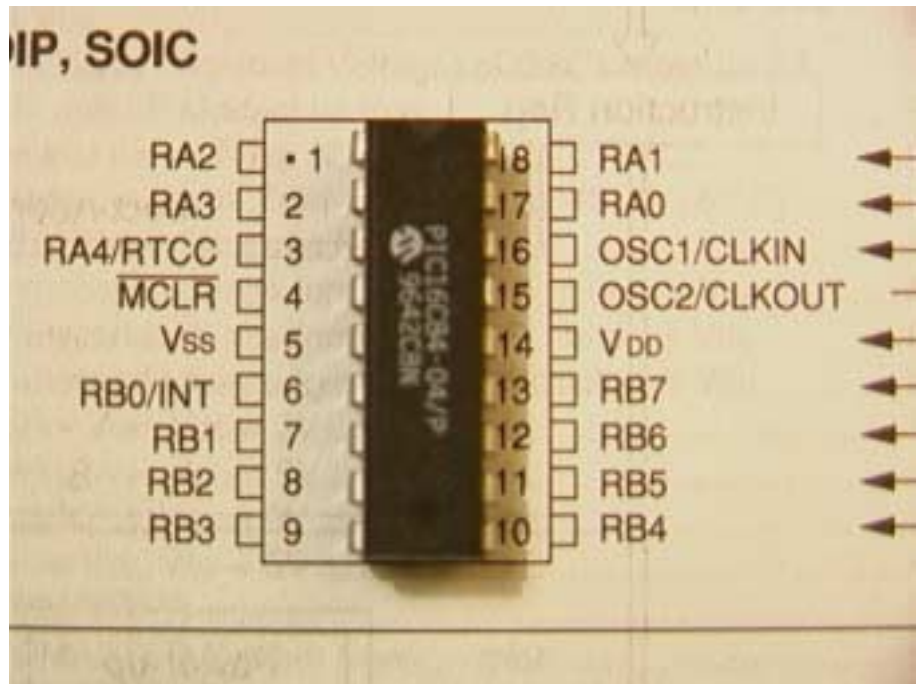

explicitly told the starting point and every single step along the way.

The biggest mistake the novice programmer makes is to sit at a keyboard and try writing a program. Here's my free advice: don't! Always start a program by outlining your objective and then investigating the best way of reaching it. The better a program is planned, the easier it will be to write and debug. Always start out with a flow chart drawn on paper in pencil and be prepared to erase it and re-draw it many times over. There is an "official" way of drawing flow charts but in reality there is no need to produce a work of art; a list of actions with arrows showing the desired program flow will suffice. Fig. 2.1 shows an example of a flow chart for the traveller to follow:

Note that the chart has start and end points as well as a course between them. This is very important in programming, especially the start point, as normally there will be a degree of

setting up to perform before the program proper starts. Some programs will have no end point - they will simply repeat a set of actions forever and where the end would be on a flow chart there would be a loop back to an earlier step. Each stage of a flow chart may represent a complete task or may only detail a small instruction but the more you break the objective into small stages, the nearer to a program it will look. Our traveller made decisions based on observing their surroundings; in PIC programming, all decisions are based on comparing numbers. The principle is the same, when some condition is met, a choice on which way to go is made.

Believe it or not, we have already covered most of the fundamental building blocks of a program, the initialisation, flow, decisions and termination. The only part missing is the interaction with the outside world. The designers of the PIC family have made this aspect of programming very simple. They treat the pins of the chip in exactly the same way as a register, in fact they are connected directly to one of

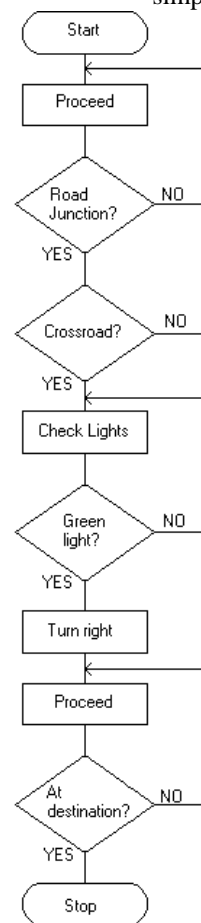

Fig 2.1



the registers. If you read the value in the register, you are actually seeing the voltage levels on the pins and if you put data into the register, its bit pattern is reproduced as a voltage on the pins. By voltage here I mean logic level - a logic zero means a voltage close to ground and a logic one means a voltage close to the supply line voltage. The only complication with treating the pins as a register is that a pin can't be an input to the chip at the same time as being an output from it. There is, of course, a way to switch the pin between input and output mode under program control; we'll see how it is done later.

It's time to start writing our first program. Bear with me for now, I'm going to show you the hard way first! This is not the way to write efficient programs quickly but, hopefully, it will show you what is really happening when we use an assembler later on. For now we will code the program by flow charting then writing the processor instructions as arrangements of binary bits. Before deciding on which instructions to use we'll quickly look at how each instruction is constructed. All instructions are made up of bit fields laid side by side. The 16C84 uses instructions that are 14 bits wide, made up from a field describing the type of instruction, a field naming the source of data and a field defining where the result of the instruction is to be stored. You might like to think of them as "where to get it from", "what to do with it" and "where to put it afterwards".

Using the "MOVWF" instruction as an example, the name is short for "move file contents" which concisely states its purpose. It takes the value stored in a file register and duplicates it somewhere else.

The 14 bits of the instruction are 001000dffffff, the zeroes and ones are fixed, they tell the processor that this is the "move" instruction, the "d" tells it the destination and the "f" bits make up the binary number of the file register which is to have its contents copied. There are seven "f" bits which gives a binary number range of zero to 3F (63 in decimal) for the source register number but only one "d" bit to select one of two possible destinations. Some instructions, like this one, will only allow you to use the W register (d = 0) or the source register (d = 1) as the

destination. If moving the source back into itself sounds a bit daft, there is a good reason why it can be useful; this instruction also sets Z bit in the status register if the value being moved is zero so it can be used to update the Z bit without having any other effects.

Another example instruction is "ADDWF", this time the mnemonic is short for "add W to file" and it is represented by the bit pattern 000111dffffff. Like the previous example, the fixed bits on the left identify the instruction type, "d" sets the destination as before and the "f" bits hold the number of the file register to which W is added.

The last example is a condition testing one, the "BTFSS" instruction or "bit test in a file and skip if set". Believe me, the mnemonic is easier to type than that mouthful. Coded as 0111bbbffffff it follows the same pattern as before, 0111 tells it what to do but this time there are three bits "bbb" to identify the position of the bit (from 0 to 7) within register "ffffff" that is to be checked. If the bit is set to a one, the next instruction is jumped over; if the bit is a zero it is executed.

All PIC instructions are made up from these bit fields in the same way. If you look at the table of instructions, you will see how similar they are and how the type of operation they perform groups them into functional "families".

Now to that program we were about to write. As they say on TV, "don't try this at home", the program won't work without some extra instructions, and would be difficult to transfer into a real chip anyway, but at least you can see how it is put together. All we will do is read the bits on the chips RA (port A) pins, turn zeroes into ones and vice versa and then output the bits on the RB (port B) pins. RA pins are electrically connected to register 5 and RB to register 6.

00100100000101 COMF with d = 0 and f bits set to 05 inverts RA pin levels, leaving result in W.

00000010000110 MOVWF moves contents of W to register 06, which are the RB pins.

That wasn't too difficult. If you break the binary numbers down into fields using the instruction table, you will see how the bit groups are composed. Note how the COMF (compliment bits in a file) neatly performs two tasks; it not only turns the bits in register 5 upside down, it also leaves the result in the W register ready for the next instruction to use it. MOVWF (move W to a file) put the contents of W into register 6, where the bits magically appear as voltages on the RB pins.

What is missing from our two-instruction program is something to tell us where these instructions are to be stored inside the chip. For that we need to add the address where it is to be placed in the program memory area. All processors have an address that they fetch their first instruction, called the "reset vector", from and because immediately after a reset the chip will be in a confused state, the reset vector has to be in a fixed location so it can be found. In the 16C84 the address is 0000, right at the first location in memory. Beware though, some PIC devices use an address at the end of memory and other types of microprocessor use even more obscure places to hide it. If we wanted our little program to run as soon as the chip was reset, we would store the first instruction at the reset vector and the second immediately after it at address 0001. In practice, our program wouldn't work properly because the instructions to make RA pins work as inputs and RB pins work as outputs are missing; we'll come to the initialisation procedures shortly.

## Introducing the Assembler

As you have no doubt gathered from my comments earlier, programming in binary is about as easy as herding cats. No serious programming person would write Microcontroller code without using an assembler and that includes you and me. Assemblers not only allow you to use meaningful words in your program, but they take care of nearly all the address generating and, as a bonus, they tell you if they think something is wrong. As the world record holder for the most error messages, I cannot emphasise how much time fixing a bug before it reaches the silicon stage saves. An assembler will normally let you know if you have a syntactical error (a line that

Instruction name	What the instruction does	Instruction bits		Status bits
		MSB	LSB	
<b>ADDLW k</b>	Add value k to contents of W	11	111x kkkk kkkk	
<b>ADDWF f,d</b>	Add contents of W and f	00	0111 dfff ffff	C,DC,Z
<b>ANDLW k</b>	Logic AND contents of W and k	11	1001 kkkk kkkk	Z
<b>ANDWF f,d</b>	Logic AND contents of W and f	00	0101 dfff ffff	Z
<b>BCF f,b</b>	Clear(0) bit b in f	01	00bb bfff ffff	
<b>BSF f,b</b>	Set (1) bit b in f	01	01bb bfff ffff	
<b>BTFSC f,b</b>	Skip next if bit b in f is 0	01	10bb bfff ffff	
<b>BTFSS f,b</b>	Skip next if bit b in f is 1	01	11bb bfff ffff	
<b>CALL k</b>	Call subroutine at address k	10	0kkk kkkk kkkk	
<b>CLRF f</b>	Zero all bits in f	00	0001 1fff ffff	Z
<b>CLRW</b>	Zero all bits in W	00	0001 0xxx xxxx	Z
<b>CLRWDT</b>	Reset the watchdog timer	00	0000 0110 0100	TO,PD
<b>COMF f,d</b>	Compliment all bits in f	00	1001 dfff ffff	Z
<b>DECF f,d</b>	Decrement the value in f	00	0011 dfff ffff	Z
<b>DECFSZ f,d</b>	Decrement f and skip if zero	00	1011 dfff ffff	
<b>GOTO k</b>	Jump to address k	10	1kkk kkkk kkkk	
<b>INCF f,d</b>	Increment the value in f	00	1010 dfff ffff	Z
<b>INCFSZ f,d</b>	Increment f and skip if zero	00	1111 dfff ffff	
<b>IORLW k</b>	Logic OR contents of W with k	11	1000 kkkk kkkk	Z
<b>IORWF f,d</b>	Logic OR contents of W and f	00	0100 dfff ffff	Z
<b>MOVF f,d</b>	Move (copy) contents of f	00	1000 dfff ffff	Z
<b>MOVLW k</b>	Move (copy) value k into W	11	00xx kkkk kkkk	
<b>MOVWF f</b>	Move (copy) contents of W to f	00	0000 1fff ffff	
<b>NOP</b>	No Operation (does nothing)	00	0000 0xx0 0000	
<b>RETFIE</b>	Return from interrupt routine	00	0000 0000 1001	
<b>RETLW k</b>	Put value k in W and return	11	01xx kkkk kkkk	
<b>RETURN</b>	Return without changing W	00	0000 0000 1000	
<b>RLF f,d</b>	Rotate bits left in f via C	00	1101 dfff ffff	C
<b>RRF f,d</b>	Rotate bits right in f via C	00	1100 dfff ffff	C
<b>SLEEP</b>	Switch into standby mode	00	0000 0110 0011	TO,PD
<b>SUBLW k</b>	Subtract W from value k	11	110x kkkk kkkk	C,DC,Z
<b>SUBWF f,d</b>	Subtract W from contents of f	00	0010 dfff ffff	C,DC,Z
<b>SWAPF f,d</b>	Swap bits 7-4 with 3-0 in f	00	1110 dfff ffff	
<b>XORLW k</b>	Logic XOR contents of W with k	11	1010 kkkk kkkk	Z
<b>XORWF f,d</b>	Logic XOR contents of W with f	00	0110 dfff ffff	Z

**Fig. 2.2 and notes:**

1. "b" in the instruction column refers to the number of a single bit (0-7) in register "f", in the bits column it holds the binary representation of the same bit number.
2. "d" refers to the destination, that is, where the result of the instruction is to be placed. If d=0 the result is put in the W register, if d=1 it is put back in register "f". "f" in the instruction column refers to the number of one of the PIC's registers. The same number is represented in the instruction bits column as seven binary bits.
3. "k" is an absolute value, that means it is treated as a numerical value rather than as the number of another register.
4. "x" in the instruction bits means the bit can be either a one or zero, it makes no difference to the outcome of the instruction. It is considered good practice to set "x" bits to zero so the instruction always produces the same bit pattern.
5. The Status bits refer to the individual bits in the Status register, these reflect the current state of the PIC while a program is running and can be checked at any time with the BTFSC and BTFSS instructions:
  - "C" – the Carry bit, is set when a mathematical carry is generated by making the number in a register too big to hold. It is also used as a link between the first and last bits when a rotate instruction is used.
  - "DC" – Digit carry, is like the "C" bit but works if a carry between bits 3 and 4 is generated. This is useful when doing math with 4-bit numbers such as BCD.
  - "PD" – Power down is used to find out the reason for the PIC starting up, it is zero after waking up from standby mode and one after power-up or a watchdog timing out reset.
  - "TO" – Time out, is zero after a watchdog timeout and set to one at power-up or when the watchdog is reset.
  - "Z" – Zero is set when the result of an instruction causes all the register bits to be zeroes.

makes no sense), are attempting to misuse a register or have branched the program to somewhere east of Cairo. I've done all these and still have scars to prove it.

I'm going to base this section on Microchip's own MPASM assembler. It comes in two flavours, DOS and Windows - both do the same job but the DOS version is, in my opinion, easier to use and much faster to run.

Microchip provides both versions on their web site [www.microchip.com](http://www.microchip.com) and on their data CD. The DOS implementation can either be started by typing "MPASM" then hitting the return key, in which case it requests

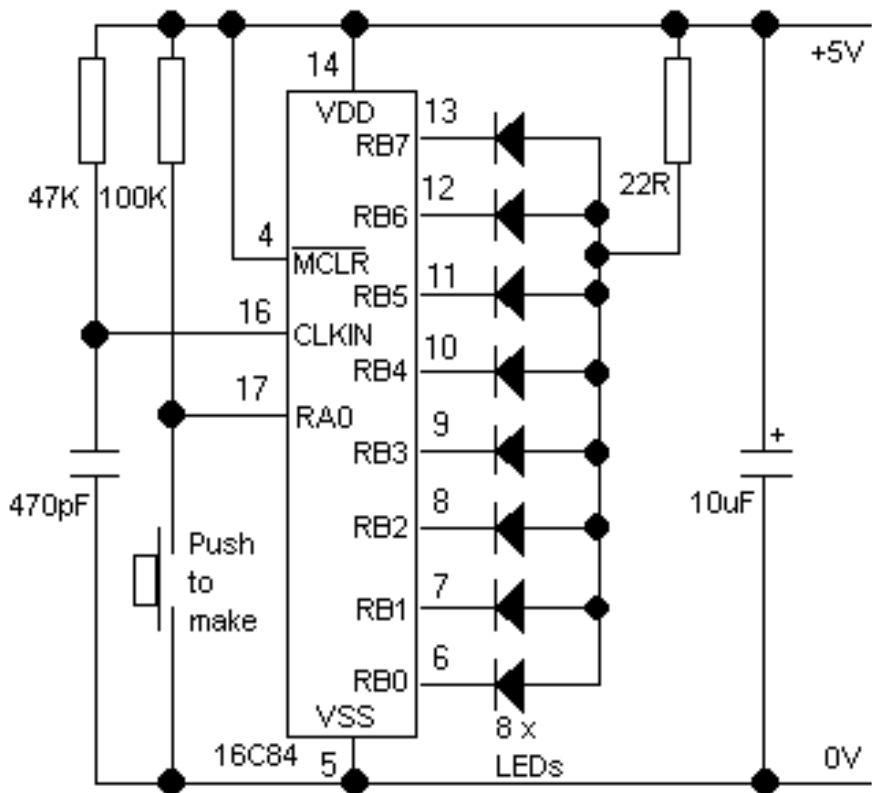

Fig 2.3

intended to configure the assembler rather than be part of the PICs program. It also takes note of the start address, which you specified, and counts the instructions, so it can track where in memory the instruction would be placed. When it comes across a “label” it notes its name and the address at which it was found. A label is a place marker you put in the program, usually to provide a target for instructions that cause the program to branch to a new memory address. For example the instruction “GOTO my\_label” would cause the program to jump to wherever “my\_label” happened to be and carry on from there. On the second pass, the assembler actually translates the mnemonics into instructions, incorporating any register names, labels addresses or fixed numbers into the machine instructions bits. Without performing two passes, any references to labels further down the program couldn’t be processed, as the assembler wouldn’t have encountered them to know where they were.

### A typical source code section

Broken down into its component parts, this code fragment has a section at the top which associates a name with a value, so that using “Port\_a” in the instruction will actually cause the value 05 to be used which makes code much more readable than using the number. It has an “org” or “origin” directive, which tells the assembler where the code is to be located when it is stored in the PIC. It also has a label “Initialise” which in this case is assigned the value 100 (it is immediately after the org) so the goto instruction knows where to jump. Labels must always start right at the beginning of a line, that’s how the assembler distinguishes them from instructions and other “equ” (equals or equates-to) words. Although it is possible to use labels having the same name as instructions or directives, I

details on a menu like screen, or by typing “MPASM <source file>” where the source file is your hard written code. The latter method is generally easier, especially if you put the assembler settings at the start of your file. The source file is assumed to have a name ending in “.ASM” unless you tell it otherwise and it produces files of the same name but ending in “.LST” and “.HEX”. The LST is a text listing of your source code with the addresses, machine codes and comments all placed side-by-side - it is invaluable when tracking down obscure bugs. The HEX file is the binary code in a format ready to feed into most programmer units; it contains lines of text made from a header with the address in it and

a string of hexadecimal numbers. Don’t worry if the HEX file looks odd, the programming unit should know how to handle it. The assembler can also produce other files, most of which are unimportant at this stage but you might get one ending in “.ERR” if something is wrong. It is a list of errors although they are also made obvious in the listing file.

A quick word on how assemblers work is in order. Most, including MPASM, are two-pass assemblers. That means they read all the source code twice before producing the output files. On the first pass, all the assembler directives are read. They are instructions in the source code that are

```

Port_a equ    H'05'
W        equ    0
Same     equ    1

                org H'100'           ;set start address to 100 (hex)
Initialise    movf Port_a,W          ;copy contents of port a into working register
                btfs Port_a,2        ;skip the next instruction if bit 2 = 0
                goto initialise       ;if it wasn't, back to the initialise label...
                addlw H'20'          ;otherwise add 20 (hex) to it.

```

A typical source code section

strongly advise against it, as it is likely to cause confusion if you re-visit the program later and forget you did it!

The code fragment also has comments, anything following a semi-colon (;) up to the end of the line is treated as a comment and is solely there as a reminder to the programmer; the assembler completely ignores it. A well commented program is easy to maintain and debug so you are advised to use them liberally, the adage "if it was difficult to write, it should be difficult to understand" doesn't teach a good lesson.

Figure 2.2 shows all the instructions a 16C84 can execute and gives a brief explanation of what each of them

achieves. Don't worry too much at this stage if it doesn't make sense, I'll talk you through each line of assembler source code in our trial program in the next article. You might find it interesting to look at code listings in previous copies of CQ-TV, so that you can see how the instructions and other assembler instructions fit together in a working program. I should warn you about two instructions you might encounter which are not in figure 2.2, "TRIS" and "OPTION" which are present in some earlier PIC devices and left in the 16C84 for compatibility. Microchip does not recommend their use and may remove them in new designs. They allowed the value in W to be placed directly into the port TRIS registers and the option register

respectively. These can be loaded just as easily using the MOVWF instruction with the appropriate register as the destination.

If you didn't buy the components I mentioned in part one, do so now. If you construct the circuit shown in fig 2.3, by the end of the next article you should be able to see your name or call sign in lights! The construction isn't particularly critical of layout, as long as the decoupling capacitor between ground and supply is as close as possible to the chip. The LEDs should be lined up vertically with the one connected to RB7 at the top and others in sequence down to RB0 at the bottom. Keep the LEDs close together, touching if possible.

## Members only!

As mentioned in the previous issue (CQ-TV 188, page 42) we have set-up a 'members only' section on our web

site. Access to these pages requires a username and password. This quarters codes are as follows: -

**Username:** amember

**Password:** mayday

## Call sign generator

**By Chris Barker G1EZJ**

I have been experimenting with PIC chips - the PIC12C509 to be exact - and have managed to get the PIC to produce a Morse message about every fifteen minutes. My own message on my 24cm transmitter reads as follows "G1EZJ 24cm ATV station IO82VX". Obviously each chip has to have a dedicated program with the stations own information.

I also have two running on my fixed 10GHz links to G0NMY and G8SAR, and am fitting one in my FI726R. Any other suggestions would be welcomed.

The PIC runs off 5 volts and has 8 pins on it. Pins 1 and 4 are tied to 5V; pin 2 is the Morse output; pin 3 toggles with the Morse to power an LED as a front panel indication; pin 5 is not used; pins 6, 7 and 8 are tied to 0V. That is all there is to it, and it could even be fitted into a microphone (providing a 5 volt supply is available).

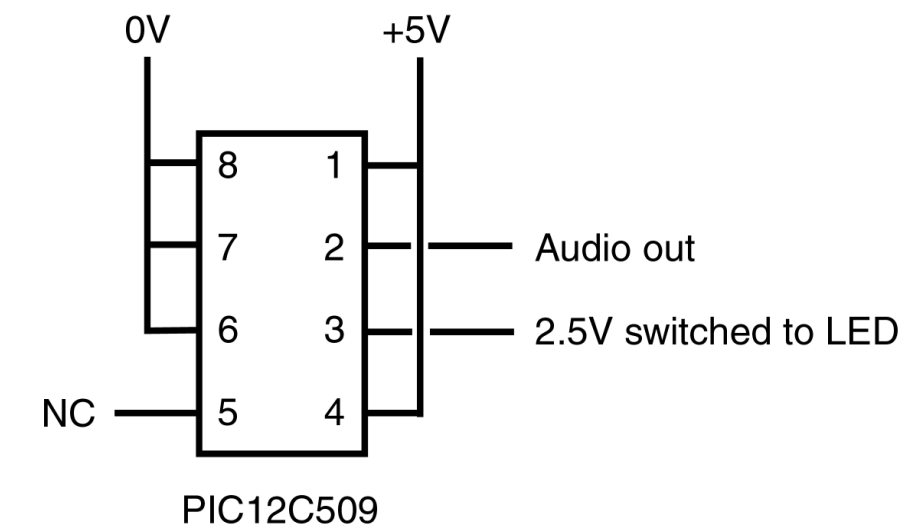

There is a further use for which this could be used. One of these could be fitted into the MIC circuit of your VHF/HF gear and set to run at a very low level in the background. Now if (God forbid) your rig is stolen, the next time the thief or the receiver of your rig tries to use it, it would give your call sign and address out in Morse as stored on the PIC chip!

If anyone is interested in my Morse ID chip then they can contact me on 01782 869247, email [G1EZJ@cwcom.net](mailto:G1EZJ@cwcom.net) At the moment, the cost of programming and supplying the chip looks to be about £10, including postage and connection details.

# Further uses of Plug Top Power Supplies

By M. H. Cox

In his Circuit Notebook No 69, John Lawrence talks about extending the use of these supplies. I would like to take the concept further still, but then I seem to be making a habit of this!

As a hobby, I am what might laughingly be called the “technical supervisor” of the IBC Message Service. I am also Vice President of IBC, but that is nothing to do with this piece. It has been the custom at IBC to provide a service of information, messages for lost delegates, and promotion for various activities on a series of monitors around the show ground. IBC99 had about 90 in all.

These are mostly PAL receivers fed from the RAI cable distribution network, but with some 8ft x 6ft projection displays, usually fed SDI.

The heart of the service is a jury-rigged control “room” in a corner of the main Technical Facilities area. John Holton (former Chairman/MD of Aston Electronic Developments) and I arrive a few days before the show and build up the facility. Last year we borrowed 4 Aston Ethos and Motif character generators. I provide two specially adapted COX switchers for output control, as well as a few little monitors



Figure 2 - Component DA

(LCD home brewed devices, some of them), all the cabling and power distribution, and an edit facility using a specially built 8 x 4 analogue component routing (YPbPr) switcher. This is to enable material to be dumped onto the 2 or 3 DPS computer edit systems that are used for compilation of promotions, stings etc.

Where do the power supplies come in, you ask? Unfortunately the Aston machines only provide one YPbPr output, and the system needed at least 2 separate feeds. In previous years, I had taken out a rack of Avitel DAs, but these were a bit ancient, and took up a lot of space and weight. Thoughts turned to building some 3 output YPbPr DAs in as small a box as possible.

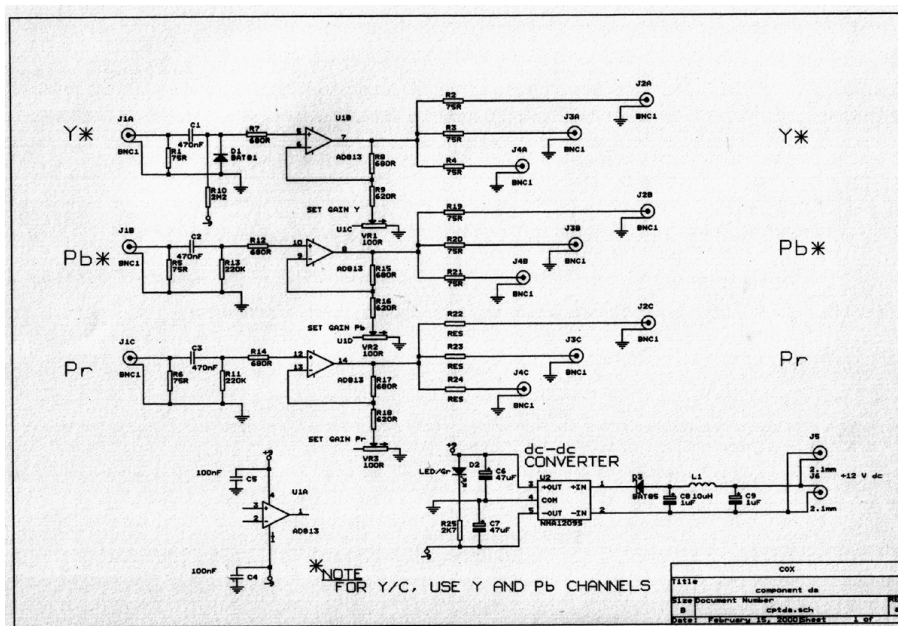

Figure 1 - Circuit Diagram of Component DA

Safety and size considerations suggested low voltage power, but although the plug top supplies are excellent, they are only single voltage, and my thoughts were towards split rail supplies. (EMI circuit influence rather than Marconi!). Newport makes a very useful series of dc-dc converters starting at around £6 for the 1-watt version. Also available are 3 and 4 amplifier 14-pin DIL op-amps with 100MHz bandwidth. One of these (AD813, Analogue Devices) is used together with a Newport NMH1209S dc converter from 12 volts to +/- 9 volts. The DA is fixed unity gain into 3 75-ohm loads, and works well. 4 of these were built with all components including BNCs (triple BNC on a strip, available from Westside Supplies Ltd, 01423 860626) on a single PCB.





Figure 3 - Component DA pcb

DC was input on 2 x 2.1mm connectors to provide a loop through facility.

Argos (and others) sells a Uniross 1.5 - 12 volt regulated 1A block for £9.99, and one of these drove the 4 DAs and

had power to spare for other uses.

My home brewed LCD monitors use the same connector, and hence can run on the same supplies. Plug top psus, particularly the regulated version, will

work equally well, although are not man enough for the LCD monitors as these usually need around 700mA. Most new units that I have built recently use this power arrangement, even an audio mixer. The other advantage is that I have a stock of Sony

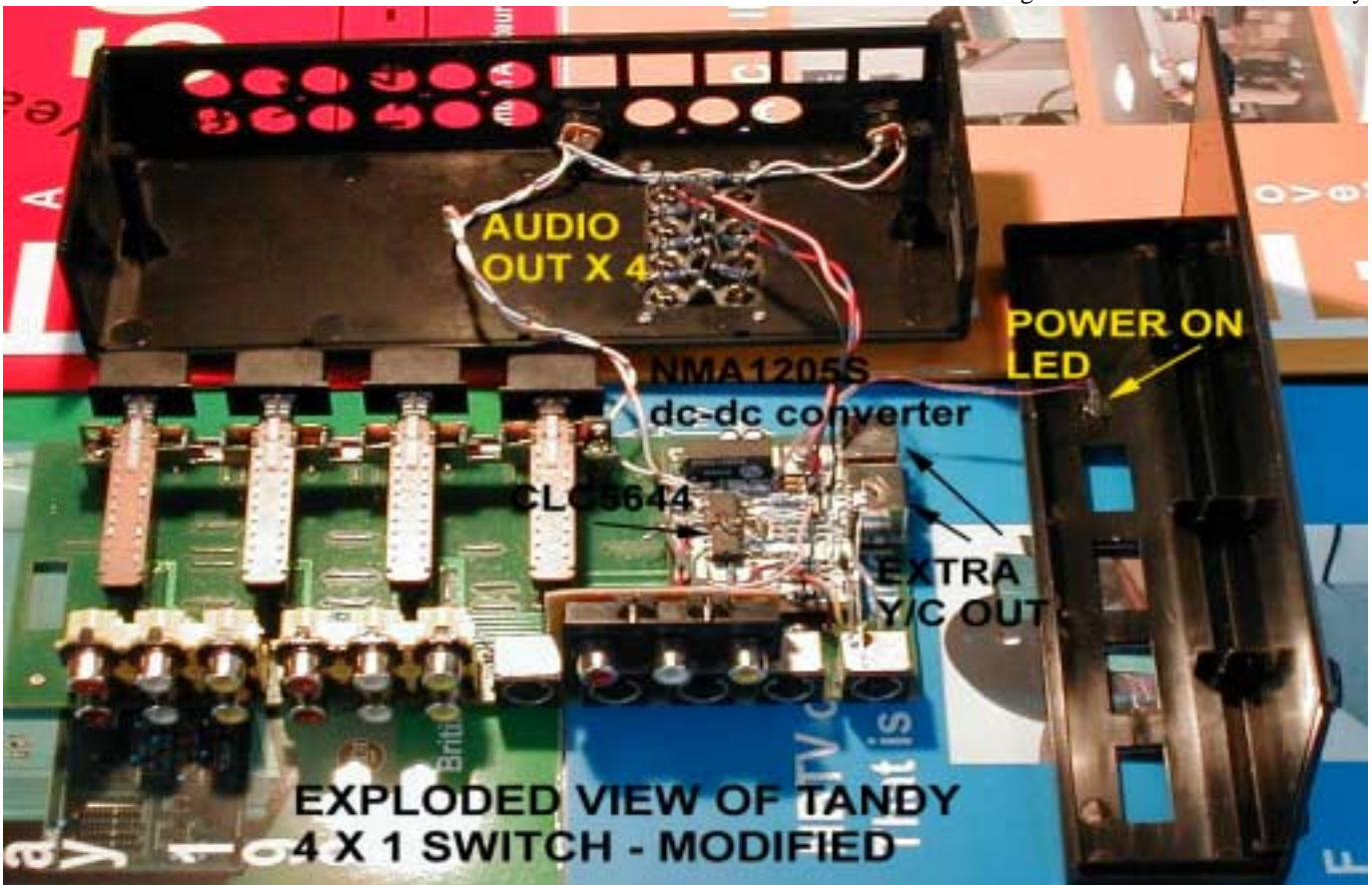

Figure 5 - Exploded view of unit





Figure 4 - Modified unit on top of original uni

NP1 (12v, 1.5Ahr) batteries, and with the use of a cunning contact clip (Hawk-Wood), these can drive any piece of equipment using the 2.1mm connector. As a practical point, a Schottky diode in series with the dc input is well worth fitting in case of polarity reversal, and expensive consequences. A further benefit of using dc-dc converters is that other 12-volt units can be run from the psu without worrying about ground currents or hum loops. Fig. 1 shows the circuit diagram of the Component DA while Fig. 2 and Fig. 3 show the outside and inside (pcb) of the unit.

Another application is in making a very cheap switcher with multiple outputs for use in VT editing. I have a Sony DHR1000, a SONY GR-D300 (both DV machines), a DPS Perception system built into a WinNT computer, and the house S-VHS machine. Most of these have Record inputs that will take Y/C and stereo audio. Tandy make an excellent 4 x 1 switcher using good old mechanical switches and switch 5 layers - Y/C, composite and stereo audio, for the princely sum of £12.99.

However there is only one output. Thoughts turned to the possibility of building a simple DA into the box, and adding the extra output sockets necessary. National/Comlinear make a 4-section current mode op-amp which has a 170 MHz small signal bandwidth,

which should be adequate, and a output current of 70mA which again is adequate to drive 3 outputs into 75 ohms. It is also relatively cheap at about £4.50 (Farnell). The pin out is as a TL074.

Power comes once again from a Newport 12 volt to +/-5 volt dc-dc converter and a pair of 2.1mm sockets to run off the ubiquitous "plug top supply".

This device uses so little current that power is looped through on way to one

of the LCD monitors that are used for editing.

Fig. 4 shows modified switcher standing on unmodified unit, Fig. 5 shows an exploded view of the modified unit, and Fig. 6 shows the circuit diagram.

Farnell of Leeds is a good source for the AD813 and CLC5644 ICs mentioned, and stock a good range of Newport dc-dc converters.

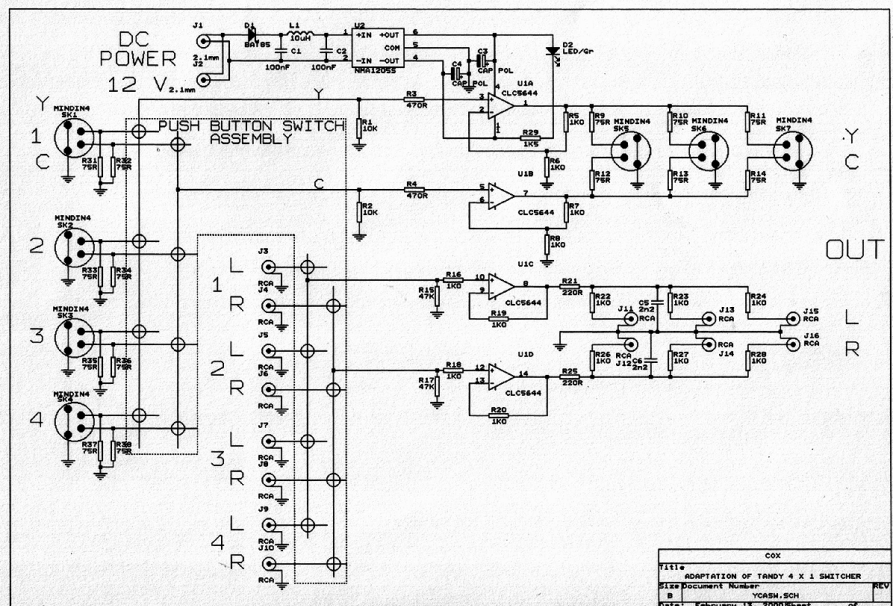
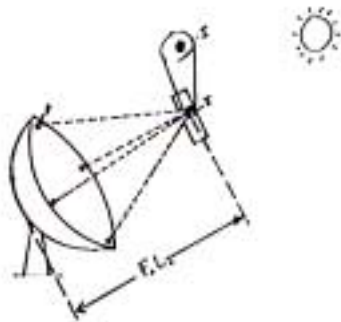

Figure 6 - Circuit Diagram of Y/C and Audio Switcher

# Profiling RF Parabolas

By George w. Allen, N1BEP

The focal length of parabolas to be used for antenna reflectors may be found by temporarily cementing small (one centimetre square) mirrors around the edge of the dish at the four quadrants, as shown in figure 1. The dish is then aimed at the sun on some temporary mount, and a small white target is positioned so that the four mirror images coincide. This reflected image is at the focal point and phase centre of the parabola, at which to locate the RF feed. The target should be temporarily mounted at this focal point.

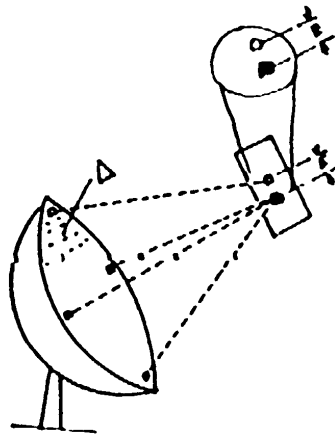

**FIGURE 1.** Parabola aimed at the sun, with mirrors mounted around the edge. F. L. denotes the focal length from the centre to the focal plane of the image, I.

Note that the parabola should not reflect much sunlight, or it will override the small mirror images.

If the dish is distorted, one or more of the mirror images will not fall on the locus of images, but will fall onto one side, as shown by "E" in figure 2. Another small mirror may then be moved around the dish to determine the places where the dish is not a true parabola, and whether the dish is distorted plus or minus from an ideal

curve. If the dish is too flat, the image will fall outside the focus, and lifting the mirror will bring the moving mirror image into focus.



**FIGURE 2.** Parabola with mirrors reflecting an area of distortion in the parabola, DELTA. The resulting image at the focal plane shows a displacement of one mirror image, E, where r. f. energy would not be picked up by the feed to the parabola.

Conversely, if the dish has too much curvature, the movable image will cross the focal point to the other side of the focus, "DELTA" area in figure 2. This method will allow marking the deviating areas of the dish.

In order to check the results, a profile of the parabolic section can be made by locating a stiff paper template from the centre of the dish to an edge, as shown in figure 3. This should be located on a radius believed to be on the true parabola. The profile of the parabola is traced on the paper, and the pattern is

cut out. This is "T" in figure 3, the template.

This half-parabola template can then be rotated about the centre line "C/L" in figure 3, to observe the areas where the dish deviates from a true parabola. For best accuracy, it may be necessary to refine the curvature of the template by re-cutting the profile.

Only a true parabola will reflect r. f. waves constructively to the focal point, but mirrors reflecting sunlight can be arranged to shine on the focal point while not being on the true parabola.

A one-metre plastic ex-TV dish was obtained to be used as for the low GHz. microwaves. In locating the focus, it was found that about twenty percent of the dish area would not reflect to the focus, and so the expected gain could not be reached. The plastic had evidently deformed with aging.

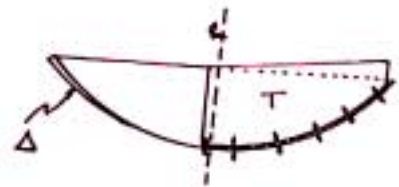

**FIGURE 3.** A cross section of a parabola is shown with a template, T, cut to follow the parabolic curve from the centre line, C/L, to the edge. This template may then be rotated around the centre to show where areas of the parabola deviate from a true parabolic curve, area DELTA.

**Don't forget the ENIGMA CONVENTION and ANNUAL RALLY on Sunday the 7th of May 2000**

By John Lawrence GW3JGA

## SSD and SMD

I recently purchased a kit of parts for building the very nice little 24cms TX/driver unit as described in CQ-TV 185 pages 22-28. The components needed very careful handling; some were SMD (Surface Mount Devices), very small and fiddly. The VCO module and some other devices were SSDs (Static Sensitive Devices) and easily damaged by a discharge of static electricity. In view of this I decided to take the necessary precautions so that the SSDs could be unpacked, handled and assembled without being subjected to any electrostatic discharges.

## Static Electricity

Static electricity is a common phenomenon, producing clinging clothes, the 'zap' when sliding out of your car, etc. It can be generated by the parting of two dissimilar materials, by the rubbing of dissimilar materials (tribo-charging) and induced by electrostatic fields from charged persons or objects.

## My Chair

For example, my shack chair is the usual swivel type with 5 plastic castors. When I sit on it and roll across the carpet I become charged to about 4000 volts. If I touch the corner of the metal filing cabinet I can draw a small spark, this would be sudden death to an SSD.

To make my chair safe, I decide on a common earth point nearby (e.g. the earth pin of a mains socket) and connect the chair to it through a flexible curly cord in series with a 1Mohm resistor. The resistor limits the discharge current and dissipates any charge generated by moving the chair. Direct earthing of the chair might pose a safety hazard to the operator.

## The Bench

The workbench needs to have an electrically dissipative surface, to dissipate and conduct away any charge, which might otherwise build up on objects placed on it.

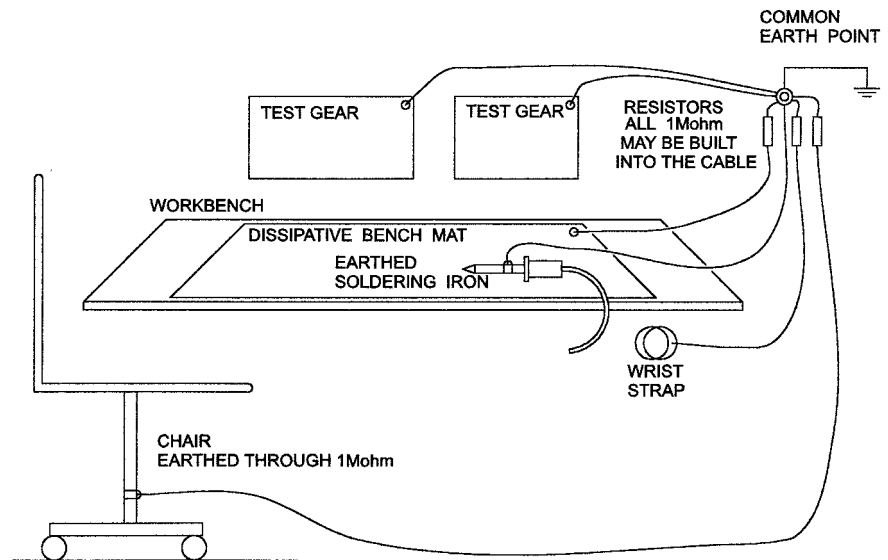

Fig 1. STATIC SAFE WORK AREA

Years ago, my old workbench had a real wood surface, grubby, scratched, coffee stained and with the odd soldering iron burn. Because it had such poor electrical insulation it would have been ideal for handling SSDs, any static charge would have leaked away quite quickly. Now, my bench has an insulating plastic laminate top and is not at all suitable, so I need a static dissipative bench mat (e.g. Maplin CH47B). The mat is connected to my common earth point through a lead in series with a 1Mohm resistor, as before.

## The Operator

Now what about me? If I walk, with my vinyl-soled shoes on the nylon carpet, or move about in my polyester shirt, my body may become electrostatically charged. To prevent this, I need to wear a conductive wrist-strap (e.g. Maplin FE29G), which is connected to my common earth point through its curly cord and the included 1Mohm resistor. Direct electrical connection of my wrist would definitely be a safety hazard!

## The Soldering Iron

Here the problem is different. An unearthed soldering iron may have high 50 Hz voltages present on the bit due to capacitive coupling between the heating element and the casing of the bit. Because of this, the soldering iron bit should be connected directly to

earth, without a series resistor. If the soldering iron does not have an earth wire already, it will be necessary to fit a clip to the tip and attach an earthing wire to this. For obvious reasons, don't solder on live equipment.

## Test Equipment

Test equipment should be earthed directly to prevent similar problems to those posed by the soldering iron. In most cases test equipment will already be earthed because of coax cables and other interconnections.

## The Static Safe Work Area.

An overall view of the Static Safe Work Area is shown in Fig.1 above.

The work area must be clear of insulating plastic bags and boxes, which otherwise might introduce static charges, only the black static dissipative types should be used.

What I have described may seem like overkill when applied to the home workshop, but if you are handling an expensive integrated circuit (e.g. a Mitsubishi RF Power Module costing £45) then the precautions are well worth taking.

It should be remembered that electrostatic damage to a semiconductor device may not show up

as an immediate catastrophic failure but could easily result in reduced performance and/or a shortened operating life.

## Surface Mount Devices (SMDs)

I had intended setting out my personal hints and tips for handling, placing and soldering SMDs, but in the course of gathering information I came across a booklet by Bill Mooney entitled 'A Practical Introduction to Surface Mount

Devices'. This little book, which is published by Babani and available from Maplin, is excellent value at £4.99. Chapter 5 'Hand working with SMDs' has just the right kind of information for the home constructor. Recommended.

## References

1. RS Data Sheet 'RS ESD Products', Electromail (RS Components Ltd.)

2. Maplin Catalogue, 'Antistatic' section.

3. Bill Mooney, 'A Practical Introduction to Surface Mount Devices'.

Babani Electronics Books No. BP 411 (Maplin GS42).

## TV on the air

### By Graham Hankins G8EMX

#### Constructing the 'Dove' receiver

With a licensed ATV repeater so close to the Lea Valley Leisure Centre, it was decided to attempt to arrange some actual ATV for the BATC stand at the March show at Pickett's Lock. I therefore decided to build the Bob Platts 24cm Rx and hopefully have it in use, on demonstration, over the exhibition weekend.

The paperwork with the kit comprises six A4 pages of building guidelines, a components list, board layout and circuit diagram. I normally choose to place resistors first, value by value i.e. all the 470 ohms etc. I find this much quicker than trying to find the value that is R1, then R2 etc. Same with capacitors and here I had to use the lens from a slide projector to see some of the printed values! One particular component was new to me – what is a 0 Ohms link (plain body, black band) Bob? There are several normal wire links too, also some socket positions not used in the basic kit, so be careful because there will be 'holes left over' hi!

A glance at the receiver photo in a 'CQ-TV' confirmed that the IC's were soldered directly into the board – no sockets. But were they static-sensitive? The instructions did not mention any precautions, so in they went. I found that the 'legs' of the dual-in-line IC's needed a gentle squeeze to fit the rows of holes, and I would have been advised to put the IC's in before the electrolytic capacitors.

A trip to Birmingham's Maplin emporium was needed to obtain the tuning and variable pots, and oh dear can someone make a video of how to assemble those connector blocks? It looks easy, but I had a terrible job getting those spring contacts to lock into position within the block!

There is absolutely nothing to adjust, so there was no great surprise when a picture appeared first time (after tuning in, of course!). I'm a very careful constructor you see hi! It took me about six hours to build (yes, for reference, I did note the time)

No sensitivity or other performance tests have been performed, but the 'Dove' kit receives ATV, which is 'what it says on the tin'!

#### Pickett's Lock

##### Day 1 – Friday – setting up.

10am – Some exhibitors already preparing tables in Red Hall, Blue Hall not yet available.

12 noon – Plan is to receive the 24cm Enfield ATV GB3EN repeater so John Douglas G4DVG and Roger G8IUC arrive to put 24cm and 2M antennas on Pickett's Lock roof! This had been agreed with RadioSport and Southgate ARS some weeks before. Tables for Blue Hall being unloaded and arranged.

2pm – Feeder cables descending from roof onto BATC stand, which is now nearly covered by exhibition goodies. 'Dove' receiver connected to monitor and powered up. Picture appears straight away, things look good.

4pm – Stand layout finalised. As self-declared 'King of the Sellotape' I am refixing the banner advertising the Bletchley Park Rally. All is as set as it can be, retire to caravan (then pub) to await opening of show tomorrow.

##### Day 2 – Saturday,

10am - exhibition opens. We desperately need more room on the BATC table, so my beloved repeater map has to go. Roger is already there, receiving GB3EN and has provided a transmitter and camera to put pictures in, plus 'look through', which proves to be a main attraction throughout the day. Then Brian Summers appears with (lots of!) books and CQ-TV's, followed by Tom Mitchell with Bletchley Park leaflets! We eventually 'sort out' all this stuff - meanwhile the 'punters' are filling the hall. Very shortly later, the first 'new member' is signed up, and some stock is moved. Very shortly after THAT, an ex - ATVer arrives at the table to give us a load of BATC books back!

##### Day 3 – Sunday.

Quieter than yesterday, but punter numbers gradually build. Receiver kit continues to sell, helped by built version on show and kit documentation on view.

"Happy Birthday GB3EN"! So begins the March newsletter from the North London Television Group (NLTG) to mark 12 months from the initial switch – on of the Enfield 24cm ATV repeater on 12<sup>th</sup> March 1999.

That switch -on coincided with the Saturday of the Picketts Lock Rally last



year, so the BATC stand was happy to announce this new arrival. However, for the March 2000 event a couple of months ago, we were able to 'go one better' by arranging to be able to 'work' via GB3EN from the BATC table.

The Rally is organised by RadioSport and the Southgate ARS, so we had arranged with these and with John Douglas G4DVG, who is secretary of the NLTG, to have a table position suitable for running a length of feeder from an antenna on the roof of the 'blue' hall. This all had to be installed on the Friday afternoon before the rally, of course, so John Douglas and Roger Glover G8IUC arrived with an helical antenna on a tripod, metres of reasonable feeder and a hard hat! Roger found his way up to the roof, John communicated via 2M and very soon there appeared lengths of feeder dropping down amazingly near our table location! A built 'Dove' receiver was powered up and the 'EN test card output appeared on the monitor at P5.

For the rally 'proper', Roger provided a satellite receiver (the built 'Dove' Rx was for folks to examine while they considered buying the kit!) and his own transmitter. GB3EN was monitored 'live' throughout the rally weekend, with pictures from the rally transmitted into the repeater and simultaneously received as 'look through'. Several other stations appeared on 'EN, so visitors were able to witness actual ATV in action.

The North London TV Group newsletter lists 20 stations that can 'see' EN and many can access EN too. Many of Bob Platts' 'Dove' receiver kits moved over the weekend, so let's hope a few of these actually get built and more folks at least start to look at EN and other repeaters around the country.

The ever – faithful Severnside ATV Group has sent me its latest newsletter, 'P5'. This Spring 2000 issue runs to 10 pages, including a 4 – page 'GB3ZZ Upgrade'! It may be difficult to imagine how 'ZZ could be substantially upgraded, but the antenna system has been completely replaced, including an improved transmit Alford-Slot antenna, transmitted deviation has increased to near the maximum allowed and the entire antenna system redesigned to be

easily dismantled for inspection or further improvements.

The Severnside Group is considering the replacement of the BBC micro control by a Pentium based PC. This would offer the possibility of a "huge number of features to be added" so the Group is seeking the views of its members before committing substantial quantities of expense and time! The questionnaire on the back page of their newsletter lists eight repeater upgrade projects also eight potential kit projects! STG members are urged to respond to this for further consideration by the STG committee.

Another reliable correspondent is the Home Counties ATV Group with its 'Line Out' newsletter. No major rebuilds of GB3HV here, but several circuit changes to 'tweak' the performance or to remove annoying problems. I always find these detailed circuit changes most fascinating; genlock line wobble caused by poor recovered syncs from the stripper stage – stage re-biased and a big C put right on top of the timebase IC to remove mV of video from the DC supply. Total loss of sync lock – caused by TOO MUCH line sync into the timebase IC!

Unfortunately, and in contrast, the Leicester Repeater Group does not appear to be enjoying any good fortune at the moment. The February 2000 edition of 'LENS' announces the Annual General Meeting for 27<sup>th</sup> April at a venue to be announced.

Subscriptions and other reducing income is causing sufficient concern for the newsletter to begin talking of eventual closedown of the Group and, of course, its repeaters, which includes ATV repeater GB3GV. Any members with outstanding annual subscriptions are urged to renew quickly! The LRG can be found on the Web at <http://www.metalmike.free-online.co.uk/lrg/>

Finally, for anyone planning to visit The Dome at Greenwich, a few TV related 'tips', and a few non – TV related ones hi! There is a lot to see before you even get into the Dome itself; allow at least half an hour to view the videos in the information area near the bus terminus; make sure you visit the Sky TV chroma key Studio with very nice kit to inspect, plus live demonstrations of the 'Open' interactive TV shopping/Email etc system.

Once inside the Dome, absolutely loads of video presentations to view, wide screen flat TV screens everywhere; make sure you pick up a 'voting card' from various info desks AND use it AND 'download it' (yes, it is a smart card) after leaving the Dome. I arrived at 11am (paying cash on the day, but don't rely on doing this) and my 'timed ticket' for the Body Zone was for 4pm. If you cannot stay that long (I couldn't) get there early – you will need more than 'One Amazing Day' anyway – trust me on this one!



**John Douglas G4DVG (left, secretary, NLTG) and Roger Glover G8IUC with helix antenna used to work GB3EN during Picketts Lock Show.**

# Worthing Video Repeater Group



**GB3VR GB3RV & GB7VRB**



[www.videorepeater.co.uk](http://www.videorepeater.co.uk)

## 1Watt FM-TV 24cms Transmitter

The 1 watt transmitter generates its signal at the wanted frequency which can be set anywhere in the band, colour or B/W. On board intercarrier sound and fixed pre-emphasis are standard features. The kit includes the PCB all the on board components, pre-drilled heat sink, an Eddystone Di-cast box and full and comprehensive instructions. Building time is three evenings work. The new price for this kit is £85.00, P&P £2.50. Available to licenced radio amateurs only.

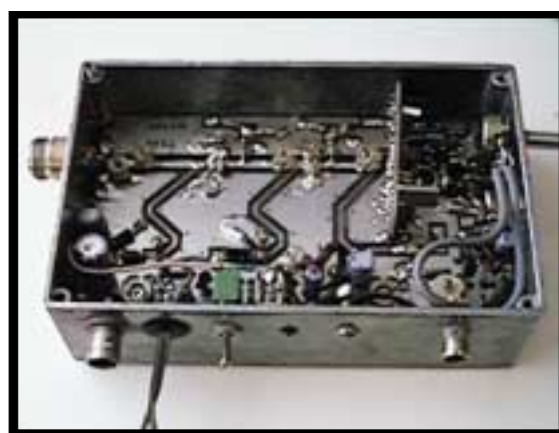

## Two channel phased locked loop kit.

This add-on kit vastly improves the overall stability of the 1-watt transmitter two crystal locked channels and a third free running tuning position are available. Kit price £30.00

## Amiga ATV Program-2

The New Amiga ATV program has more features than ever, up to 56 testcards, 20 wipes, superb text control, 30 screens of text messages, QRA calc, Testcard music, selectable displays, and this version has a DTMF tone pad to control your repeater. All testcards are over-scan i.e. the whole screen is used, Load in your own customised testcards, Extra large text, scrolling text, clock, callsign extensions, Hot key operation, Doc reader, ATV Cli, Cross Hatches, Purity and a comprehensive section for genlock users. For any Amiga with 1meg or more, state callsign and QRA (if known) when ordering, this three disk set is now only £10.00 P&P 75p

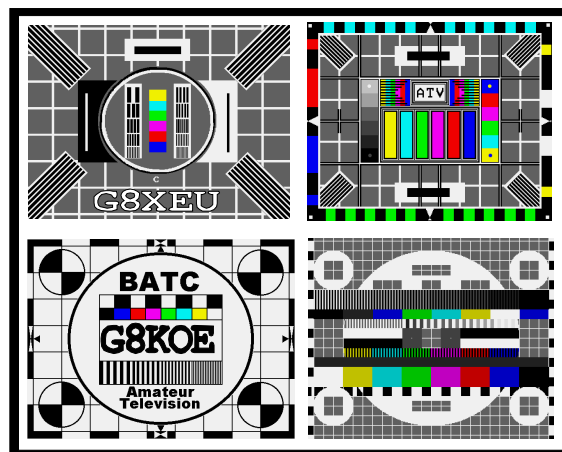

## Video AGC Kit

The Video AGC is capable of excepting signal levels in the range of 0.15Vpk-pk to 2.5Vpk-pk and generating a constant output level of approximately 1Vpk-pk Kit. Price £20.00 + P&P 75p

PC-ATV now available, see web site for details.

Visit the all new GB3VR-RV web site at:- <http://www.videorepeater.co.uk/>

Orders should be sent to: -

Treasurer of GB3VR, R. Stephens, 21 St. James Ave., Lancing, Sussex, BN15 0NN.  
Cheques payable to "WVRG" Tel (01903) 765760 7 to 8pm.



# In Retrospect

There were several errors in the IC table on page 18 of CQ-TV 189, at the end of the 625 line to 30 line converter article. The correct (I hope) version is shown below.

### IC Table

10nF ceramic decoupling capacitors to be connected across each IC. Unused CMOS inputs to be connected to 0V.

To simplify the circuit diagram the connections to  $V^{dd}$  and 0V are not shown on CMOS ICs

No.	Type	$V^{dd}$	0V
1	LM1881	8	4
2	74HC02	14	7
3	74HC4040	16	8
4	4001	14	7
5	4024	14	7
6	4082	14	7
7	4046	16	8
8	4516	16	8
9	4516	16	8
10	4516	16	8
11	4516	16	8
12	74HC257	16	8
13	74HC257	16	8
14	74HC257	16	8
15	74HC257	16	8
16	74HC75	5	12
17	74HC75	5	12
18	74HC00	14	7
19	HM6264A	28	14
20	74HC00	14	7
21	4520	16	8
22	CA3140	7	4
23	4528	16	8
24	CA3306E	12	3

**HS PUBLICATIONS**  
7 Epping Close, Derby DE22 4HR, England  
☎ 01332 38 16 99

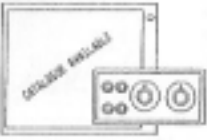
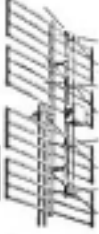
- DX-TV CONVERTERS • VHF-UHF TV AERIALS
- DX-TV PUBLICATIONS & VIDEOS
- AMPLIFIERS • FILTERS • HARDWARE
- TECHNICAL BOOKS
- BBC TEST CARD MUSIC C.D's
- TV CLOCKS & ARCHIVE PUBLICATIONS

Send 3 First Class stamps for our latest Catalogue  
*Personal callers by prior arrangement only please.*

## S. Marshall

20dB gain 10GHz horns      **£25.00**

Waveguide 16 and 17 flanges      **£5.00**

Slot antennas and filters made to order.

For further information, contact: -

**S. Marshall, G6NHG,  
25 Carlcroft,  
Stonydelph,  
Tamworth,  
Staffs., B77 4DL.**

**Telephone: 01827 897920. 7:30pm - 10pm weekdays.**

**Amateur Television Quarterly**

Great articles on :

- ATV
- BALLOONING PROJECTS
- SSTV
- ATV ACTIVITIES





USA \$18 Year  
Canada \$20 Year  
DX \$26 Year  
(US Dollars)

*Do you have these books yet?*

**ATV Secrets Vol 1** is a great book for the beginner. 64 pages of answers to your questions about starting in ATV! Only \$8.95 plus shipping.

**ATV Secrets Vol 2** is 292 pages with 90 ATV Projects. Only \$24.95 US plus shipping.

Get BOTH for ONLY \$29.95 US plus shipping





Write or check webpage TODAY for more information!

Published by Harlan Technologies  
5931 Alma Dr., Rockford, Illinois 61108 USA  
<http://www.hampubs.com>

**OSCAR Satellite Report**

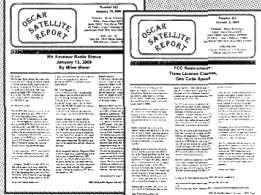
A great NEWSLETTER published twice a month to keep you up to date on what is happening. Sent FIRST CLASS MAIL!



USA \$35 Year  
Canada \$38 Year  
DX \$46 Year  
(US Dollars)

VISA  
M/C  
AMEX

## By Paul Holland G3TZO

Welcome to another edition of Satellite TV News. This issue reflects your news and views and also tries to cover some basic ground for those still contemplating joining the digital satellite TV revolution.

## Post Bag

A number of people are currently interested in using their PC to control a Digital Satellite Receiver. Douglas Gibbs wrote asking for an update on the Win 95 program called D REMOTE V1 mentioned back in CQTV No 180. This fully programmable d-box remote control programme was an early development for those trying to exploit the capability of the Nokia Mediaboxes (D Boxes). The most popular current software for these receivers including the Nokia 9600 is the DVB2000 (by Dr Overflow) which was described by John Rainer in his excellent article in CQTV 186. As reported by John DVB2000 has a comprehensive array of features that in addition to controlling every function and parameter of the receiver also now include MPEG2 hard-disk Record/Playback. Details can be found at <http://www.dominance.net/overflow/>.



Screen grab from RX using DVB2000

A general point for the faint hearted like me (and definitely not the amateur spirit!) is that using software like this will inevitably invalidate any guarantee from Nokia, although the software is well supported by the authors via their web page.

John Jaminet, W3HMS enquires as to likely reception from European

satellites at his location. Although those satellites having a footprint targeted on Europe will not be receivable there are now an increasing number that do carry European programming to the US. The opening of EUTELSAT's Atlantic gateway at 12.5W and Telstar 12 at 15.0 Deg W will further extend this capacity. John says "currently I have a 10 ft dish without descrambler but there is little to commend it to a viewer other than satisfaction of curiosity, HI!" Let us know how you go on with your

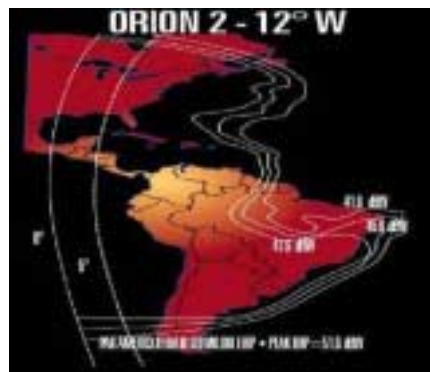

Telstar 12 (Orion2) at 15 Deg W

reception from Europe John.

Brian Alderson G3KJX writes in to say, "Please can you help? I am part owner of a villa in Portugal. Some of the other owners want Sky Digital. I know that officially it is not available out there but some insist that it is obtainable. Can you tell me where I am likely to obtain the information" The best and most up to date reference data for satellite positions, footprints and transponder loading can be found at the Lyngemark Satellite Chart on <http://www.lyngsat.com/index.html>

Astra 2A, which carries the Sky digital service at 28.0E, utilises separate North and South beams. Each transponder is allocated to one or the other beam. This means that some services are receivable in Spain/Portugal with a 50cm dish, whereas others may require a much larger dish (1.0m plus) depending on how far South and West the location is.

John Gaut, GOCCV has given details of equipment in use at his QTH. He says, "At home I use a 1.8mtr IRTE prime focus dish with a H-H mount modified with a little 6 inch actuator for inclined

tracking use. This operates with a home-brew control unit fitted out with a C/Ku co-rotor at the sharp end which feeds a network of three splitter/combiners feeding both C band & Ku band signals to an ODM300 digital RX used ninety nine percent of the time for news feeds. Also being fed with C / Ku band signals is my trusty old Echostar SR-8700, getting on a bit now, but has been as solid as a rock since day one, many many years ago".

John GOCCV, John Bodle G7WHX and John Tournier G3INZ all confirm their interest in going digital. G3INZ is still using his old analogue Discus Ellipse with a motorised 1.3m antenna. John, G7WHX is interested in the RSD3000 and John GOCCV in the new

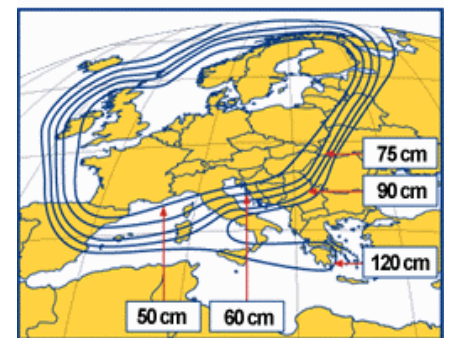

Astra 2A (North Beam)

Echostar AD3000IP – more of this later.

Barry Gunstone has sent some photographs of his very chilly looking QTH in Sweden. He uses a perforated 1.3-meter dish and actuator connected an old Monterey 40 with an external Pace 100 Videocrypt decoder plus a 1-meter dish on 28.0° E screwed to the balcony connected to a Sky Digibox (Pace). He says "I get great digital 16:9 pictures with the Digibox in conjunction with my Christmas present to myself, a 32-inch windscreen 100Hz Dolby pro logic 5/6 channel surround sound Philips TV". He also has a larger 1.2 meter dish pointed at 1.0° W and a smaller 90cm dish on 5.0° E that are connected to a Grundig D2MAC Receiver. A further 90cm black perforated dish on 19,2° E shown in the picture is connected to a RSD ODM3-00 FTA digital receiver. Thanks for the



**Barry Gunstone at his Swedish Dish Farm**

## Digital Basics

With so much interest in digital reception it is probably worth going over some of the basics. A quick glossary of the key terms used is a good start;

**BER:** Bit Error Ratio The preferred way of measuring link integrity. Most measuring equipment for DVB downlink performance measurement will monitor the BER.

**Bouquet:** A collection of services marketed as a single entity such as Sky Digital in the UK, AB-SAT in France or Stream in Italy.

**CAM:** Conditional Access Module. A PCMCIA card which fits into the CI slot of a DVB receiver. Cards for the various CAS such as Irdeto, Viaccess, Conax are all now available in the UK

**CAS:** Conditional Access System .A system to control subscriber access to services, programmes and events e.g. Irdeto, Viaccess, Seca, Mediaguard..

**CI:** Common Interface. A PCMCIA slot within a DVB receiver that accepts an appropriate CAM for the required bouquet or service.

**DVB (S):** Digital Video Broadcasting by Satellite

**FEC:** Forward Error Correction. A Reed-Solomon Forward Error-Correction overhead is added to the MPEG 2 packet data. This is a very efficient system that adds only about 8% overhead to the signal.

**MPEG-2:** Refers to the standard ISO/IEC 13818 [1]. Systems coding is defined in part 1. Video coding is defined in part 2. Audio coding is defined in part 3.

**Multiplex:** A stream of all the digital data carrying one or more services within a single physical channel.

**Network:** A collection of MPEG-2 Transport Stream (TS) multiplexes transmitted on a single delivery system, e.g. all digital channels on a specific satellite.

**SR:** Symbol Rate refers to the symbol rate for the link between the modulator and demodulator in the system.

**SimulCrypt:** DVB SimulCrypt standard addresses the requirements for interoperability between one or more CA systems.

## The Theory

The DVB-S system was designed to cope with the full range of satellite transponder bandwidths and is a single-carrier system. One way of picturing it is to consider it as a kind of 'onion'. In

photo below Barry and try and keep warm!!

the centre, the onion's core, is the payload, which is the useful bit rate. Surrounding this is a series of layers to make the signal less sensitive to errors, and to arrange the payload in a form suitable for broadcasting. The video, audio, and other data are inserted into fixed-length MPEG Transport Stream packets. The packetised data constitutes the payload.

A number of stages of processing follow:

- The data are formed into a regular structure by inverting synchronisation bytes, every eighth packet header.
- The contents are randomised.
- A Reed-Solomon Forward Error-Correction (FEC) overhead is then added to the packet data.
- Convolutional Interleaving is applied to the packet contents.
- Following this, a further error-correction system is added, using a punctured Convolutional Code. This second error-correction system, the Inner Code, can be adjusted, in the amount of overhead, to suit the needs of the service provider.
- Finally, the signal is used to modulate the satellite broadcast carrier using quadrature phase-shift keying (QPSK).

In essence, between the multiplexing and the physical transmission, the system is tailored to the specific channel properties. The system is arranged to adapt to the error characteristics of the channel. Burst errors are randomised, and two layers of forward error correction are added. The second level, or Inner Code, can be adjusted to suit the circumstances (power, dish size, bit rate available). There are thus two variables for the service provider: the total size of the 'onion' and the thickness of the second error-correction outer 'skin'. In each case, in the home, the receiver will discover the right combination to use by very rapid trial and error on the received signal. An appropriate



combination of payload size and Inner Code can be chosen to suit the service operator's environment.

One example of a parameter set would be for a 36 MHz transponder to use a 3/4 Convolutional Code, in which case a useful bit rate of about 39 Mbit/s will be available as the payload. The 39 Mbit/s (or other bit rates allowed by parameter sets for a given satellite transponder) can be used to carry any combination of MPEG-2 video and audio. Thus, service providers are free to deliver anything from multiple-channel SDTV, 16:9 Widescreen EDTV or single-channel HDTV, to Multimedia Data Broadcast Network services and Internet over the air.



A full hand of Cams & Cards

## Conditional Access Systems

The Common Scrambling Algorithm used in DVB allows inter-working between Conditional Access Systems in a method known as "SimulCrypt". SimulCrypt allows the same broadcast (with different embedded CA bit streams) to be viewed on several different CA-equipped receivers. Examples of this are quite common with a number of channels encrypting in say Irdeto and Viaccess simultaneously on the same frequency. The Common Interface (CI) is an interface between a standard PCMCIA module and a DVB receiver. Plug-in PCMCIA modules using the DVB Common Interface are readily available in the UK. This solution also allows broadcasters to use modules containing solutions from different suppliers in the same broadcast system, thus increasing their choice and anti-piracy options. The Common Interface operates at the MPEG Transport Stream level, and although specifically intended for conditional access, it can also be used in other applications, such as for Electronic Program Guides.

## The Practice

Having got this far it's probably worth considering how all this translates into the practical aspects of getting started with digital reception.

Those trying to make sense of digital TV broadcasting could be forgiven for being confused!! It seems that broadcasters have deliberately tried to make things difficult by choosing a large number of encryption standards.

The reason for this is that most commercial broadcasters target a specific area for which they have programme rights and usually try to monopolise the market through establishing the pre-eminence of their favoured encryption standard. In the UK we have Mediaguard encryption (Sky Digital), in France they have Viaccess, in Benelux countries they have Irdeto and in Scandinavia they have Conax. Even in these areas there are competing broadcasters with variations on a theme such as the Spanish Seca version of Mediaguard.

The first digital receivers had Conditional Access Modules built in. The first Nokia Mediamaster receivers (D-Boxes) had an integral Irdeto module but could also receive Free to Air (FTA) services. More recent receivers are either built purely as FTA (with no decoding capability) or have a Common Interface (CI) slot. This means that they either have one or two slots that will accept a CAM for the service you want to view. To view an encrypted digital service you therefore need;

- A receiver with a CI slot (or integral CAM)
- A CAM (Irdeto, Viaccess, Conax etc) appropriate to the service you want to receive (usually about £89.0 each)
- A smart card for the service you want to receive (varying prices - some legal, others not!)

The difference to be found in digital receivers is usually whether they have a CI slot or are just FTA plus;

- Some have analogue capability as well as digital
- Some have DiSEqC 1.0 switching capability (22kHz tone switching)
- Some have pseudo motorised capability (DiSEqC 1.2)
- Some have true motorised capability (36v motor drive)
- Some control polariser skew on analogue only
- Some control skew on analogue and digital

## Echostar AD3000IP

All this leads nicely to reporting on my latest acquisition for the shack from Echostar the all singing all dancing AD3000IP. Unfortunately cold weather has prevented testing the full-motorised capability of the RX but early impressions are favourable. In comparison to the Nokia 9600 the AD3000IP menu system is much more flexible. Channels can be stored by satellite. Digital channels appear first in the channel menu followed by any analogue services. Switching between digital and analogue is reasonably fast however the analogue picture quality suffers in comparison to the excellent performance from digital services.

Channels searches can be made for FTA only or a global scan of services on that satellite. DiSEqC 1.0 switching is available however most users will prefer to use the full-motorised capability. I will provide further notes on performance in the next issue.

### Channel News

**TV3, TV6, TV8, TV1000 and ZTV** were due to launch in digital on April 25 from Sirius 3 using Viaccess. It is reported that the current Eurocrypt-M D2-MAC cards will be compatible with the Viaccess encryption.

A new **Danish entertainment** is scheduled to start in the autumn and will be called TV2+.

**BRT** is available in the clear on 11.492 GHz (V), SR 30000, and FEC 3/4 from EUTELSAT W3 at 7.0E.

Italian digital channel **MEDIOLANUM** is testing in clear on 12.540 GHz (H), (SR 27500, FEC 3/4) from Hotbird 1-5 at 13.0E.

**ZDF DOCU, EUROSPORT and EURONEWS** can be found as FTA on 11.954 GHz (H), SR 27500, FEC 3/4 from Astra at 19.2 E.

**Health channels confirm launch plans.** Discovery has confirmed it plans to launch a health channel later this year. The service is likely to be available through Sky Digital.

**Artsworld**, an arts pay-TV channel, is expected to launch as part of Sky Digital by the end of the year.

**BBC Prime** announced its D2-Mac service would close from 15th March 2000 although digital transmissions continue from Hot Bird at 13 Deg E and in FTA via Intelsat 707 at 1 degree west.

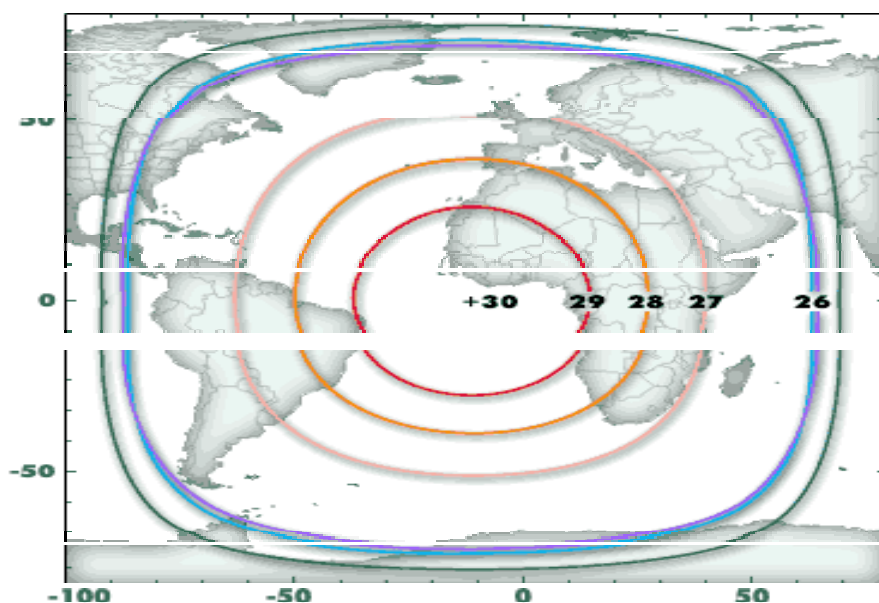

**Ekspress 3A Ku Band Coverage**

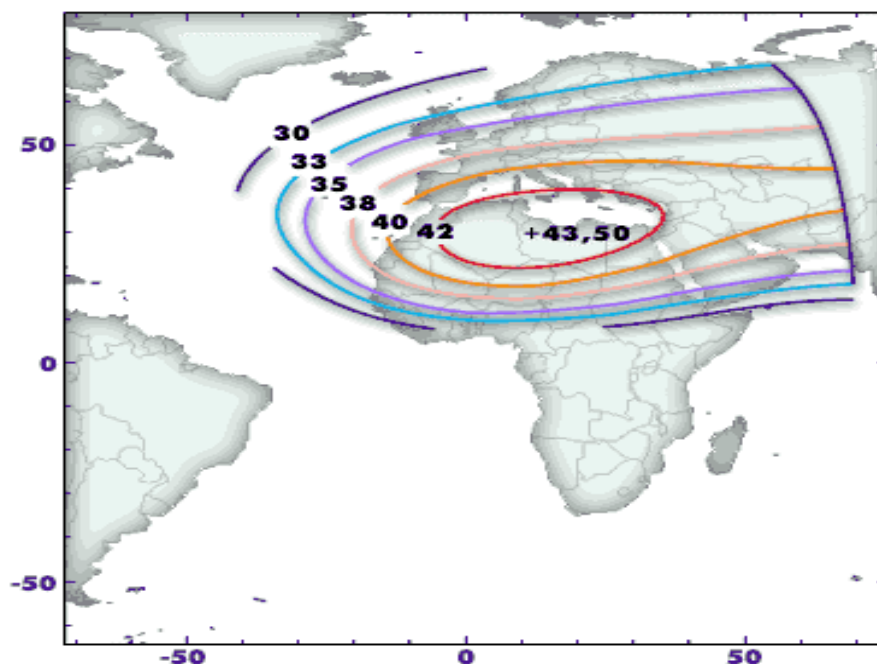

**Ekspress 3A C Band Coverage**

### New Winchester Teleport

Cable company NTL I is opening a second major teleport near Winchester. The 81,000 square meter site will

accommodate more than 20 antennas within four years.

### Ekspress-3A

A second satellite in the new Ekspress-A series called Ekspress-3A is to be launched in June and positioned at 11 degrees West. This spacecraft has 5 Ku band tps (11.450-11.700 GHz) and 12 C band tps (3.600-4.200 and will replace the ageing Statsionar-11 (Gorizont-26) satellite.

Satellite	Launch Vehicle	Launch Window	Position	Tp's
Intelsat 901	Ariane	1st Qtr. 2001	62°E	>96
Intelsat 902	Proton/Ariane	1st Qtr. 2001	60°E	>96
Intelsat 903	Ariane/Proton	2nd Qtr. 2001	24.5°W	>96
Intelsat 904	Ariane	3rd Qtr. 2001	34.5° W	>96
Intelsat 905	TBA	4th Qtr. 2001	27.5°W	>96
Intelsat 906	TBA	TBA	18.0°WE	>96
Intelsat 907	TBA	TBA	31.5°W	>96

**Intelsat IX Launch Schedule**



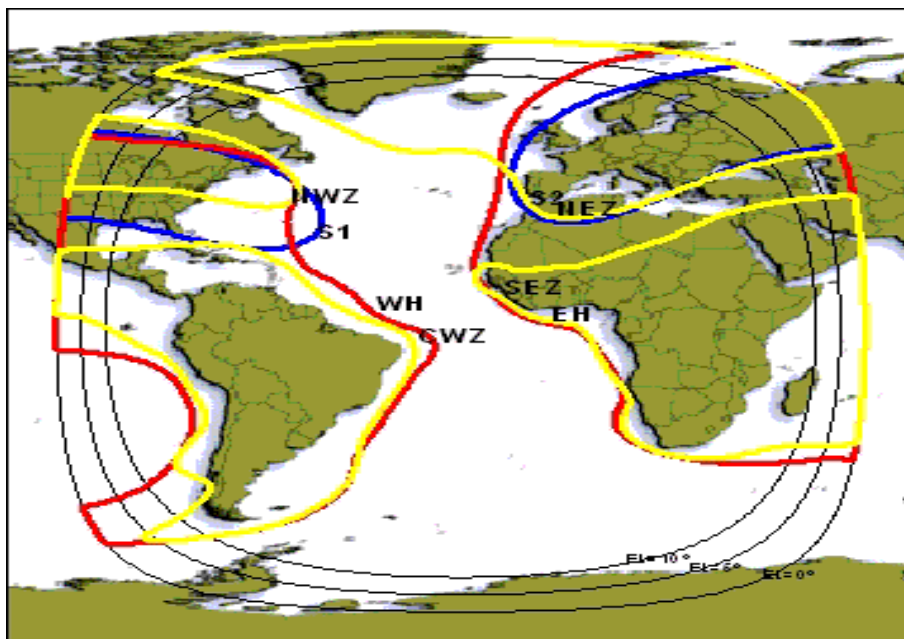

Intelsat 903 25.5 W Coverage

**GE Americom (Telstar)**

<http://www.geamericom.com/>

**Panamsat;**

<http://www.panamsat.com/>

**Conclusion**

That's it again for another edition of Satellite TV News. Please do keep writing and sending the e-mails. In the next issue I hope to add further experiences with the new Echostar AD3000IP and hope to include some details of the station set up here at Threapwood Teleport. As usual the e-mail contact is [paul.holland@btinternet.com](mailto:paul.holland@btinternet.com) or by phone on 01948 770476 (fax 01948 770552).

**Intelsat IX Series Satellites**

The forthcoming Intelsat IX series of satellite will be built by Space Systems/Loral and are designed to replace the INTELSAT VI satellites. The series will comprise four satellites with increased flexibility, advanced design, and higher capacity than any other INTELSAT satellite series. The satellites will provide digital services such as SNG, DAMA, Internet, DTH and VSAT Networks.

The INTELSAT IX Series has expanded beam coverage, superior e.i.r.p. and G/T, in both C-Band and Ku-Band compared to previous Intelsat satellites. They will allow flexible allocation of satellite capacity with full inter-connection among beams, including cross-connection between C-Band and Ku-Band. Ku-Band DTH services will allow reception with 60 cm. antennas.

**Eutelsat News**

**Eutelsat I-F4** is moving to a new position at 33 degrees East. Eutelsat I-F5 will be placed at 40 Deg E.

**Sesat** was due to be launched via a Proton launcher on April 4. It will be positioned at 36 Deg E.

**Useful Links**

The following URL's may be of interest: -

**Launch News;**

<http://www.lyngsat.com/launches.shtml>

**Intelsat;**

<http://www.intelsat.com/>

**Eutelsat;**

<http://www.eutelsat.org/home.html>



Coverage Eutelsat W4

**From 'Wireless' 1926**

**Royalties!**

One of the best radio stories of the week is that of the man who wrote to a firm of wireless manufacturers, from whom he had purchased a receiving set. To complain that he had been done. He explained that that the catalogue price was stated to include royalties, but that so far he had not heard from any member of the royal family!

**Value for Money**

I like, too, the attitude of the pirate who was recently relieved by a magistrate of a couple of Fishers for possessing no license. His set, which was made up in a soap box, was installed under his bed, and he protested vigorously that if the license fee were paid the Post Office authorities should install the aerial and the wireless set, just as they put in the telephone when you paid for that.

When I came to in the night - as one does - I was thinking about the above. I wonder if it might appear under a title

of something like "Digital Video - Questions and Answers" (and authors name). I would suggest that the stuff on 1394 onwards might make a separate instalment - it may need to be split even further, although I had got it down from 15 to 10 pages (in larger type size than used for the magazine). Regarding his copyright notice, I wonder if 'Adapted from an article by ....., whose copyright is reserved' (or something along those lines) should appear at the end of each instalment. (Have not got his text up in front of me).

# TANDATA Videotex Terminals - RAM Upgrade

By **Graham Baker, ZL1TOF**

Some time ago Tandata Videotex terminals were purchased by numerous amateurs. Some were gutted for other applications, some are in use for amateur TV, while the remainder are gathering dust in the corners of shacks

RAMs in Z2 and Z14. The link L17 (L12 on LC1) is removed and installed in L16 (L11 on LC1). This gives 6 stored pages, or 13 stored pages with 2-8k RAMs. In the Td4000 it is possible to fit a 32k RAM in Z14 along with a latch to give 37 pages.

for 32k x 8 RAM, TC55257BPI-10L, CXK58257AP10L.

A latch circuit is used to select the upper two address lines of the 32k x 8 RAM. The 74HC gate must be used as the battery powers it and other types could cause data failure or premature

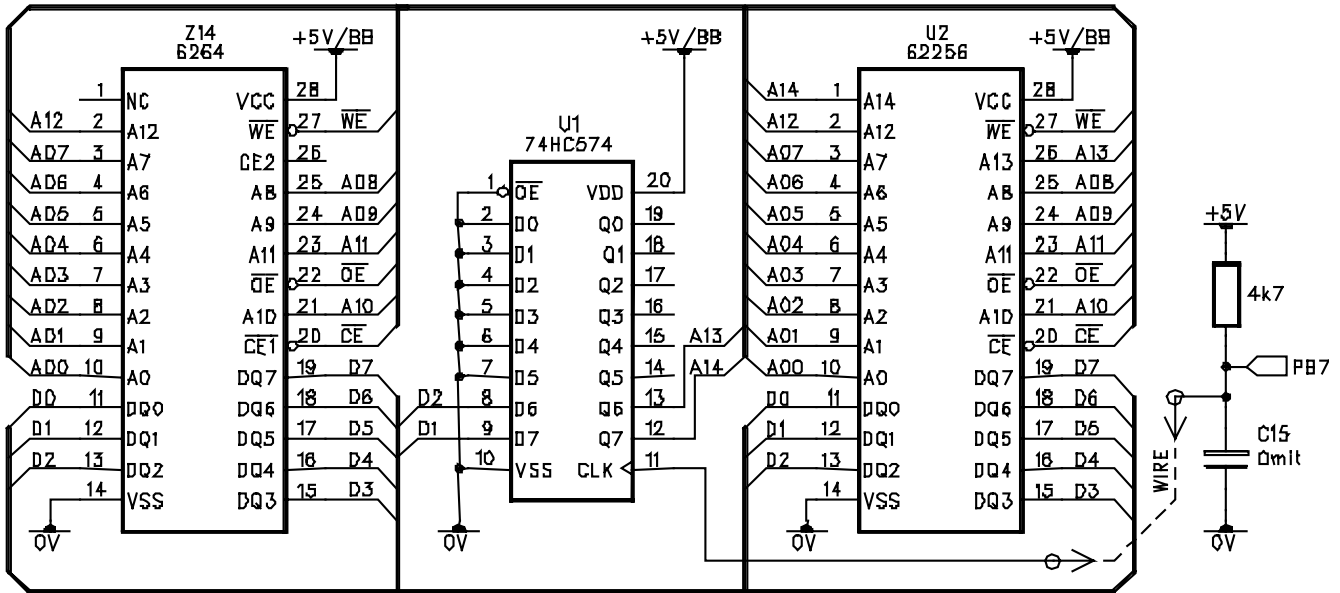

Figure 1. Schematic of 32k RAM adaptor.

everywhere. Originally these units were designed to work with a mainframe computer. In 1985 many services were available, but today as far as I know there is no service.

A common request is for more memory for more pages of text and pictures. The early Tandata units had as few as no pages, while later models had 2, 6, 13 and 37 pages of storage. The two basic models are identified simply by the PCB: LC1 is single sided and LC2 is double sided. Changing the memory is all that is needed to give additional pages.

On the LC2 (LC1), the 2k x 8 RAMs (like CDM6116AE2) can be replaced with 8k x 8

The RAM is backed up by a PCB mounted Lithium coin cell. If this cell is to last a few more years special low power static RAM chips should be used. Speed is not a problem and any RAM available today is fast enough. Suitable types for the 8k x 8 RAM are HM6264ALP-15, GM76C88AL15, and

battery failure.

The wire goes to C15 on the main PCB near Z10 and the resistor is connected to the anode of D4 to pick up the +5 volt supply. The circuit could be built on a piece of strip board with a few wires. Watch the height of your 32k RAM adaptor as in the Td4000 there is about 18 mm between the top of the LC2 PCB and the under side of the keyboard. If you have to use sockets then low profile types need to be used and C56 may need to be replaced with a radial type to allow space to fit your adaptor.

Z2	Z14	Total	Pages	Page Names
2k	none	2k	none	
2k	2k	4k	2	A-B
8k	none	8k	6	A-F
8k	8k	16k	13	A-M
8k	32k	40k	37	1A-1M, 2A-2L, 3A-3L



## ‘Repeater’ is the premier ATV magazine in Holland.

Repeater is a new ATV magazine published in the Netherlands in Dutch. The 13/24cms TX in this issue is reprinted from Repeater with the kind permission of the Editor Rob Ulrich PE1LBP. I hope we can from time to time bring you other extracts as we do with all the ATV magazines.

Information about ‘Repeater’ magazine can be found on their web site at <http://www.euronet.nl/users/rulrich>, email: [repeater-nl@rocketmail.com](mailto:repeater-nl@rocketmail.com)

Snail mail:- Gibbon 14, 1704 WH Heerhugowaard, Netherlands.

## Confidential Communications Ltd

### Video Surveillance

Design Your Own Professional Video Surveillance. Smallest pinhole camera in the world 15mm x 15mm (B&W) £29.00

32mm x 32mm Board camera, pinhole, high resolution (B&W) £29.00

32mm x 32mm Board camera (colour) £65.00

B & W Quad £79.00

Colour Quad £350.00

Picture in Picture with alarm input £299.00

1.394GHz video transmitter module, 100mW £85.00

2.4GHz video transmitter module, 10mW £85.00

1.294 - 1.3 GHz Linear PA 2W output £250.00

Four channel video receiver module with auto switcher £120.00

Time & Date Generator Module £42.00

Time, Date & Character Generator Module £65.00

5W infra-red light source £25.00

Audio amplifier module £7.00

Convert your VCR to automatic video recorder £45.00

4" LCD monitor £190.00

6.8" LCD monitor £290.00

We also stock RF parts such as Power Modules, MMIC's, RF transistors, etc...

Above prices are subject to VAT and are for one unit order, 10% discount for 5 or more.

Confidential Communications Ltd., 344 Kilburn Lane, Maida Vale, London, W9 3EF, England.

Tel: 0181 968 0227

Fax: 0181 968 0194.

e-mail: [106075.276@compuserver.com](mailto:106075.276@compuserver.com)

# 24cms Filter Experiment

By Brian V Davies GW4KAZ

With the establishment of GB3TM by the Arfon Repeater Group in 1995, my interest in ATV has increased, with construction of ATV transmitters, adapting satellite TV receivers, and construction of antennas of various configurations. This led to the ideal situation of an ATV station, of being able to see your own signal through the repeater.

To enable me to do this, I needed ample attenuation between my TX signal and my RX system.

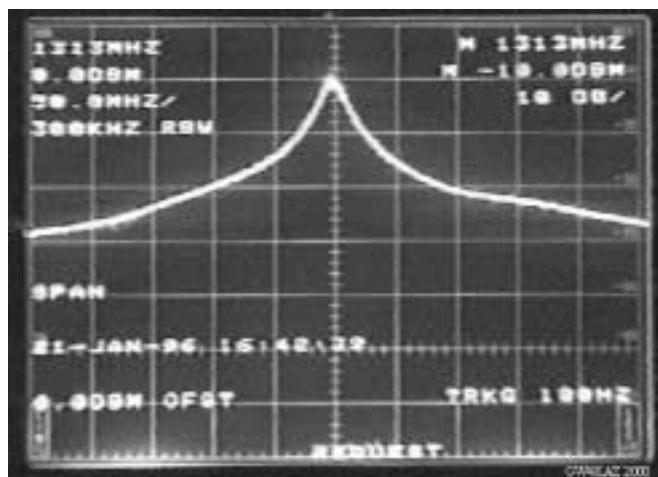

### Passband of single trough filter

This could be achieved by the physical separation of the TX and RX antennas, or by constructing a bandpass filter system.

Since physically separating the two antennas was difficult, together with attaining the signal levels from GB3TM, I had no alternative but to look at building a bandpass filter.

From studying what others, had achieved, it appeared that an interdigital filter was the unit that I required. An excellent article on the construction of interdigital bandpass filters was in CQ-TV 187, by Ian Waters G3KKD.

However I don't have the means of precision engineering that is required to build such a filter. I had to look for alternatives, with the half wave trough type filter a possibility.

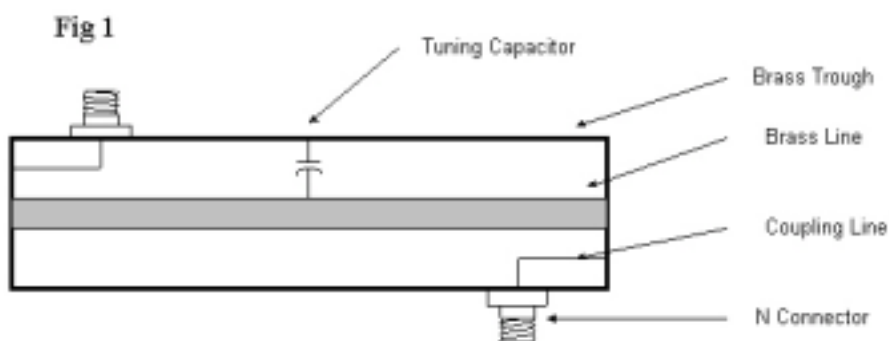

### 1/2 wave trough filter

It appeared a simple design and within

Manual fourth edition, therefore detailed construction of the filter can be left to the individual.

Fig 2

Centre Frequency: 1313 MHz

Vertical Scale: 10 dB /

Horizontal scale: 50 MHz /

Insertion loss -0.8 dB

Useful data is available in the manual, giving dimensions that can be scaled to any frequency.

Section 3.7 Table 1 gives dimensions for 1/4 wave lines; the proposed filter however is half wave so the dimensions have to be doubled. There is also a need to reduce these dimensions by about 5% to enable the tuning capacitor to bring the filter onto frequency. The capacitor will lower the resonant frequency of the filter.

Section 7.7, Fig 18 gives some detail of this type of filter; with Fig 19 giving dimensions of a 1/4-wave filter that can be scaled to other frequencies.

Section 9.22 utilises the filter in a different way to provide a doubler to 2304 MHz; again some detail is given

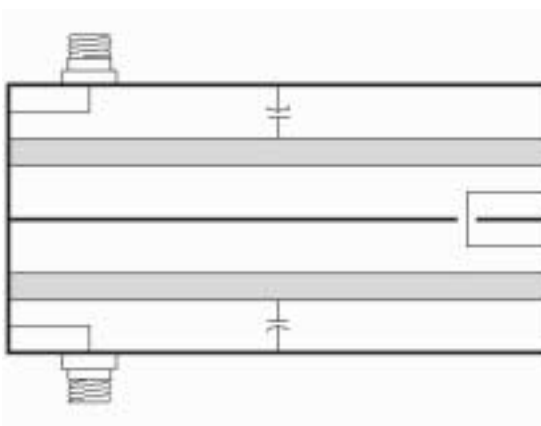

Fig 3

2 Brass troughs soldered together. The coupling line passes through the wall of each trough with sufficient clearance.

GW4KAZ 2000

### Two-section filter.



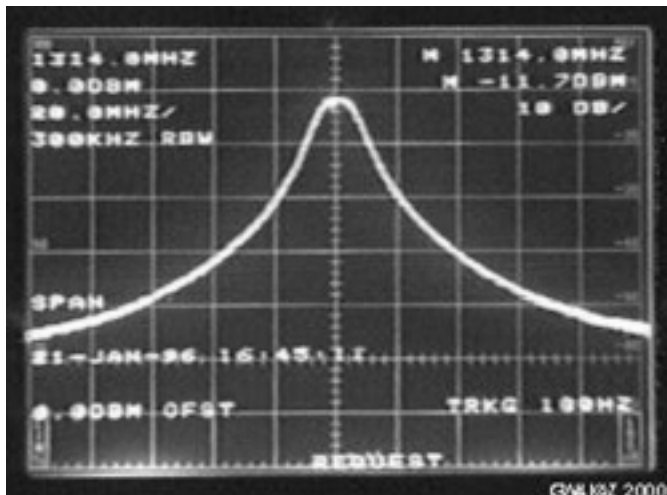

Passband of two-section filter

Fig 4  
 Centre Frequency:  
 1316 MHz  
 Vertical Scale:  
 10 dB /  
 Horizontal scale:  
 20 MHz /  
 Insertion loss  
 -1.0 dB

not what I required, and again some head scratching came into play, with a decision made to stack the filters.

Convention has it that each filter should be connected by coaxial cable of electrical length of a 1/4 wave. At 1316 MHz this length was less than 50mm, taking the velocity factor into account, and by the time connectors were fitted, it got a bit fiddly!

I decided to do away with this convention, and couple the filters as in Fig3.

Again with the use of the spectrum analyser the results now were getting much nearer what I required. Fig 4 shows the bandpass characteristic of this two-section filter.



Passband of three-section filter

Fig 5  
 Centre Frequency:  
 1316 MHz  
 Vertical Scale:  
 10 dB /  
 Horizontal scale:  
 20 MHz /  
 Insertion loss  
 -1.5 dB

Trying this filter on my home station, I was getting breakthrough, but the results were encouraging. I was not there yet.

I went a step further and constructed a three-section filter; the bandpass characteristics are shown in Fig 5. Eureka I was there, a good -60dB of attenuation, of my 1249 MHz signal, with a bandpass centre frequency of 1316 MHz, a through loss of an acceptable -1.2 dB, with a -3dB bandwidth of 20 MHz. I tried this filter on my system, and it worked!



Passband of two sections with notch filter

Fig 7  
 Centre Frequency:  
 1316 MHz  
 Vertical Scale:  
 10 dB /  
 Horizontal scale:  
 20 MHz /  
 Insertion loss  
 -1.0 dB

I am running 12 watts output on 1249 MHz, giving an ERP of approximately 120 watts.

The centres of the two antennas are less than a metre apart. I have a pre-amp on my RX system giving a gain of 17dB.

In setting up our local 2-metre repeater GB3AR, the filter system has one bandpass filter and two notch filters, the effect of the notch filters is staggering.

For experimentation I built a 1/4-wave trough to act as a notch filter and attached this as Fig 6, the result is shown in Fig 7. The notch has the effect of increasing the attenuation by at least -10dB at a specific frequency - a useful reference for the future.

The latest ATV repeater to come on air, on the 1st February, was GB3GW by the Arfon Repeater Group. Filters were

of possible constructional techniques.

I constructed a filter as Fig 1, with passband characteristics given in Fig 2.

I was fortunate in that I was able to use a spectrum analyser with a tracking

generator to carry out these tests; in fact without the use of the analyser it would be very difficult to tune the filter onto frequency.

The results showed that I was on the right path. However the passband was



required for the repeater, which was to operate with only 30 MHz between the transmit and receive frequencies.

This gave a few problems, which will be a subject of a separate article. I produced filters for this repeater, i.e. a three-section filter in the tx system and a five section with two notch filters for the rx system.



**Passband of GB3GW rx filter**

Fig 8 shows the passband of the rx filter giving 60dB attenuation at the tx frequency.

The two notch filters were staggered in frequency, so as to give more

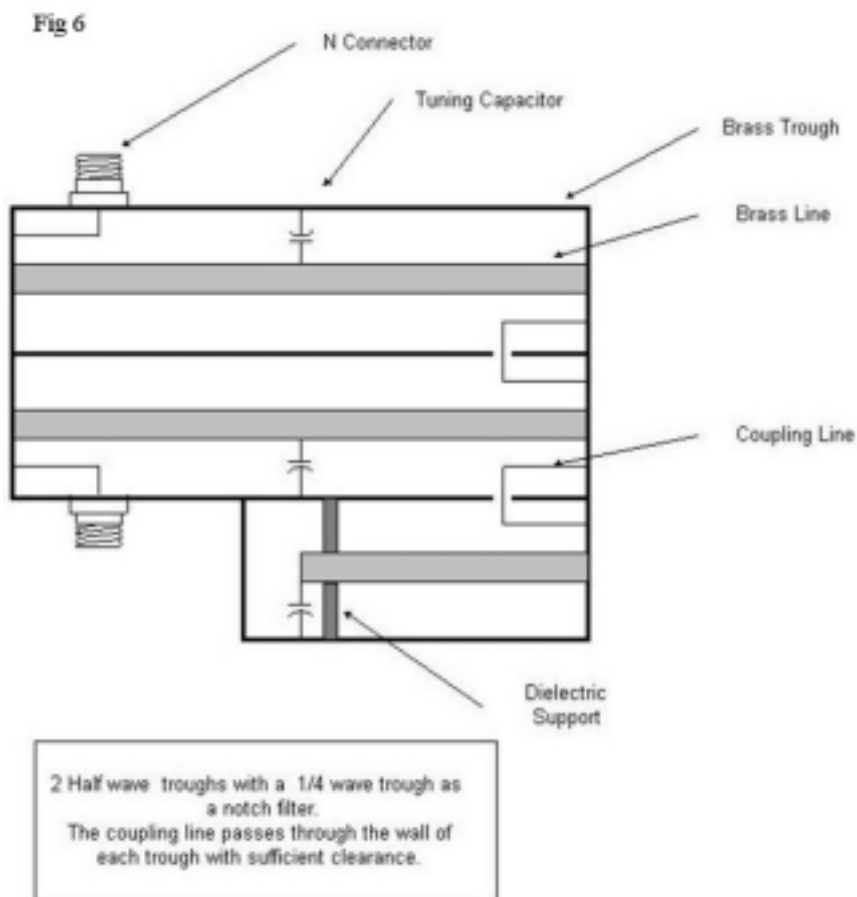

**Two section with notch filter**

bandwidth around the tx frequency, since we are working with a broadband signal.

If we tuned the two notch filters to the same frequency, then an attenuation of

around 100dB could be attained.

Five sections I think is a bit of overkill, however it works with a through loss of less than -2dB at the pass frequency.

Remember also we are working here with a 30 MHz split frequency.

I have constructed the trough type filter for 70cms, and a 1/4-wave type for 2 metres, both with encouraging results.

The 2-metre type (two 1/4 sections coupled together) is being used by a local amateur to suppress qrm from the 150/160 MHz users!

One piece of equipment that is essential in testing and setting up these filters is the spectrum analyser with tracking generator.

I now have the construction of these filters down to a fine art, and can provide built units if required.

E-mail: [briankaz@dial.pipex.com](mailto:briankaz@dial.pipex.com)

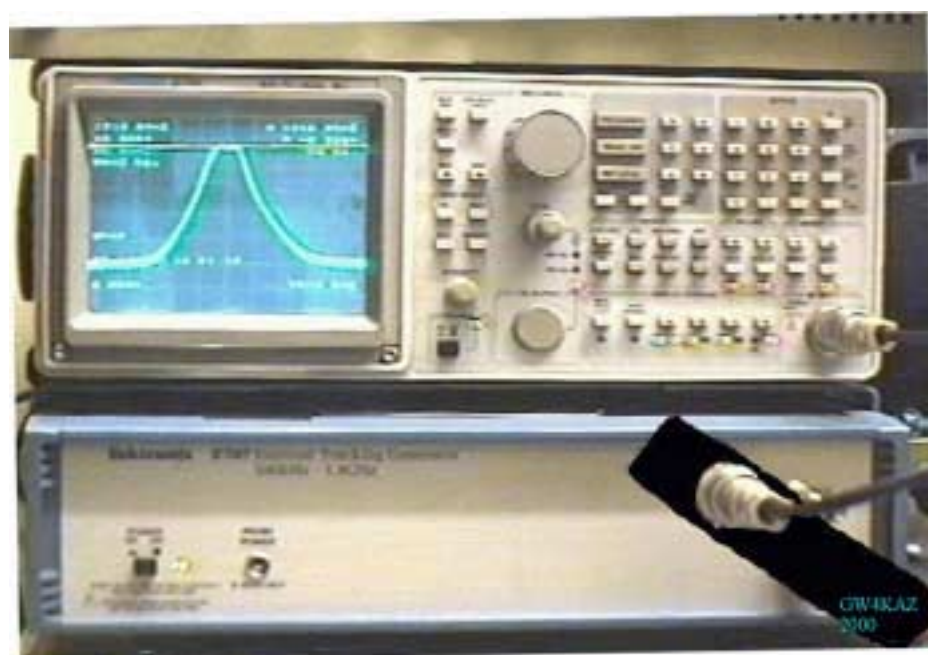

**Tektronix Spectrum Analyser in use.**

---

## Television Repeater in Trouble

---

### By John Senior G7RXS (Chairman - Leicestershire Repeater Group)

The Leicestershire Repeater Group run four repeaters, GB3CF 2 metre voice, GB3LE 70cms voice, GB3UM 6 metres voice and of more interest to this readership, GB3GV, their TV repeater run by David Payne G8OBP.

Over the last couple of years the group have seen their income substantially reduced and a shadow is now beginning to creep over the long-term future of the group. Part of the problem is that whilst they have a good site on high ground with an 18-metre mast atop, which gives them good coverage, their site is expensive to maintain. Rates, rent, electricity and insurance eat up over £600 per annum whilst their subscription income falls well short of this.

Their main source of income has always been the Leicester Amateur

Radio Show, formerly held at Granby Halls in Leicester and now at the International Exhibition Centre at Castle Donington. What happens is that members of the various Leicestershire radio clubs, groups and societies volunteer their services, free of cost, to the Show Committee to perform all the various portering, stewarding and other tasks associated with the successful running of a large show of this nature. All volunteers gain free admission to the Show and depending on the number of hours they work may get free meal and tea breaks.

After the Show any surplus funds are distributed to the clubs providing volunteer workers on a basis proportionate to the number of hours of support provided. Put more simply the more hours the more funds. For various reasons this groups share has reduced considerably over the last two years and in spite of many expenditure cuts and cost saving measures put into place by the committee the future is still uncertain.

The only way forward is for the Group somehow to increase its numbers of members attending the Show as volunteer stewards and this is where you can help. If you join the Group (membership £10 per annum, concessions £7.50), necessary for insurance purposes, and turn up at the Show you will both help the Group and help to keep the GB3GV TV repeater on the air. I myself have attended for all three days for the last 7 years and have thoroughly enjoyed it. One makes many new friends and renews old acquaintances not to mention getting discount from some suppliers.

Further details from John Senior, Email [seniorja@aol.com](mailto:seniorja@aol.com) or phone 0116 284 1517

Email preferred as I work strange hours and really do like my bed just occasionally.

---

## Digital TV deal for Zoran and Infineon

---

Infineon Technologies and Zoran are to develop and license a highly integrated single-chip digital TV decoder.

The device will integrate video, audio, graphics, communication, processing and embedded memory with the aim of making it ideally suited for Internet-connected TVs. The project also aims to create a complete system reference platform that will allow OEMs to reduce time to market.

Ruediger Stroh, senior vice-president and general manager of Infineon's computer and networking peripherals group, said: "I am excited to work with Zoran. By combining its proven track record in making such technologies like DVD and Dolby Digital a standard household item with [our] experience in the communication field, we expect a success story for both companies as well as for our customers."

Zoran, while retaining a primary focus on the DVD and digital camera

markets, is increasingly seeking out partnerships across other markets.

Alon Ironi, Zoran's vice-president of engineering, said: "We are excited to work with Infineon's engineers on this challenging development. This international collaborative development project will enable us to reach a new technological peak."

Reprinted from Electronics Times, 8<sup>th</sup> March 2000. [www.dotelectronics.com](http://www.dotelectronics.com)

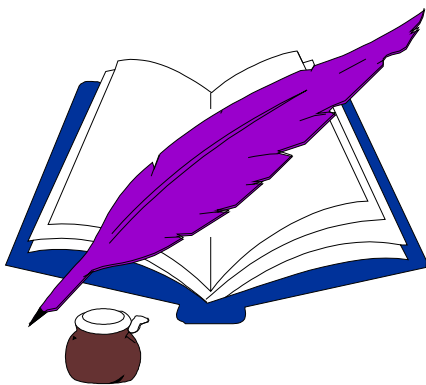

Please send all correspondence for **Post and News** to the CQ-TV Editor. Ian Pawson, 14 Lilac Avenue, Leicester, LE5 1FN, England.

Tel: 0116 276 9425.

E-mail [editor@cq-tv.com](mailto:editor@cq-tv.com)

Members' sales and Trade adverts should be sent to the advertising manager, Trevor Brown, 14 Stairfoot Close, Adel, Leeds, LS16 8JR.

Tel: 01132 670115.

Email: [adman@batc.org.uk](mailto:adman@batc.org.uk)

Dear Sirs,

The implication in the "bolted on Bit" of the Circuit notebook No. 69 is that most of those PSU's in a plug top are unregulated. While I would agree that a large number are not in my experience it is quite surprising how many are full blown psu's. Even quite small ones boast a plethora of components in there little plastic confines. Failed ones should be dissected, (sometimes hacksaw time) as they are a good source of rectifiers and regulator chips mostly 7805 & 7808's. These psu's appear to fail because of the thermal fuse going o/c. As this usually hidden within the windings, the transformer is just junk.

On the also addressed subject of standard of coax power plugs. Yes, chose a common standard, and wire a reverse Diode across the equipment power input to save expensive things. I

use "Center is Positive" and this relates to the deep fear of having the plug outer welled to the car floor, when the lead is dropped. Although is practice this is unlikely as cars have carpets, it is a good way of getting through a box of fuses through accidental loops, collisions with aerial connectors etc.

Personally this phobia is so deep as I find it beyond amusement to think that many designers Still use the outer positive approach. Do American cars still have positive earth (which also came from the GPO and Tramways in UK)? I am seeing the shrink next week.

D. J. Long, G3PTU

### From the Internet

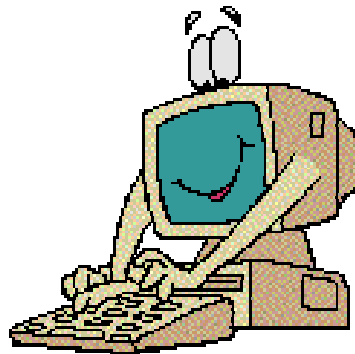

Hello All,

Many of us will recall that one year ago today on January 1, 1999 we were entertained by a series of exciting Amateur Radio SSTV pictures being sent from the Mir Space Station. Commander Gennady Padalka sent pictures of himself aboard Mir along with his Flight Engineer Sergei Avdeyev as they were celebrating New Year's Day. They showed us a New Year's tree and other gifts of a chocolate bear and apricot juice, which they had received for the occasion.

At last count more than 40 articles and news releases were made regarding SSTV from Mir. One of the stories ran by MSNBC on Jan 1, 99 is still running at:

<http://www.msnbc.com/news/227580.asp>

During February 1999 the Mir crew was joined by French Astronaut, Jean-Pierre Haignere who helped send many more fine pictures. The entire crew departed Mir in August, 1999 and Mir is now running under computer control via Moscow. Many of us wonder what the above crewmembers are doing these days? If anyone has info about them it would be interesting to know of their activities. As to Mir itself, there is recent news that can be obtained by bringing up the above URL and clicking on the last referenced link at the bottom of the text,

"MIR NEWS 29 December 1999 (472)" or by entering:

<http://infothuis.nl/muurkrant/mirnw472.html>

Further news on the possibility of the reactivation of SSTV aboard Mir in the year 2000 and plans for Amateur Radio SSTV aboard ISS will be related as it develops. Farrell Winder,

W8ZCF.

With reference to my recent article "Low cost satellite ATV conversion" and Graham Galbraith's reply in the following CQTV edition:

Graham Galbraith, MOADR's comments are welcome regarding the use of inexpensive satellite equipment for access to ATV.

I, like him, started out a few years ago with a converted SRX200 and has given me and probably may others an easy start into this interesting aspect of radio.

Perhaps we should not underestimate the use and significance of such kit. (I still have a few in storage used for odd projects!)

The time aspect in my article however, relates to the many days and weeks

cumulative work of experimentation to optimise 23cms reception with earlier generation receivers.

One could say that this in itself is well worth the experience.

I agree that with a reasonable 10GHz LNB conversion or close proximity to a 23cms repeater with a good LNA, the

Amstrad SRX200 does allow an easy entry with excellent results.

Lets keep up the enthusiasm and use of ATV!

Regards, Duncan Head, G7PNE



Two interesting websites on ATV in Poland. The first is bilingual (English/Polish), the second in Polish only.

[http://friko4.onet.pl/wa/atv\\_sp5/index.html](http://friko4.onet.pl/wa/atv_sp5/index.html)

[www.kki.net.pl/~sq9apr](http://www.kki.net.pl/~sq9apr)

Andy Emmerson.

# GH Engineering

 **MITSUBISHI**  
SEMICONDUCTORS

East Cottage, Chineham Lane, Sherborne St. John, Hants RG24 9LR

GH Engineering specialises in semiconductors for Microwave and ATV.

## Mitsubishi Power Modules

M57762 - 18W - 1.24-1.3GHz    £48.00

M67715 - 1.2W - 1.24-1.3GHz    £40.00

Also available: - BFQ34    £10.50 - replacement for the obsolete BLV91

BFR96S    £2.50 - general purpose UHF transistor

MAR-6    £2.00 – low noise Modamp – equivalent to MSA-0685

## Mitsubishi GaAsFETs

MGF1302    £3.50

MGF1402    £16.00

Note that Mitsubishi have recently increased the price of some of the PA modules, including the M57762

**Now available** – The GH ‘QUAD’. 24cms solid state PA using 4xM57762 for up to 80W out for ATV. Available as a mini-kit, including PCB, un-drilled heatsink, mounting plate and all PCB-mounted components with full instructions. Check web site or ring for latest details. This is a no-tune amplifier, but is not suitable for novice constructors. *Construction notes available free on the web site.*

The above devices are always in stock. All other Mitsubishi PA modules and GaAsFETs available to order, please ask for details. GH Engineering is able to supply many other RF semiconductors that have become obsolete or difficult to find. All prices are full inclusive, but please add £1.50 handling for orders under £10. Please send cheques made payable to **GH Engineering** to the address above, or order by phone with any major credit card.

GH Engineering    Tel 01256 869603

Email: [sales@ghengineering.co.uk](mailto:sales@ghengineering.co.uk)

[www.ghengineering.co.uk](http://www.ghengineering.co.uk)

## Members adverts

Non trade advertisements are placed in this column free of charge to paid up members only. Please quote your membership number. Copy should be sent to:-

CQ-TV Editor, 14 Lilac Avenue, Leicester, LE5 1FN, England.

E-mail: [editor@batc.org.uk](mailto:editor@batc.org.uk)

## For Sale

FOR SALE: A number of copies of CQ-TV from the early 1970s can be had from a shop called Quinton TV, College Road, Quinton, B32 1AB. Ring 0121-422 6075. Modest price.

FOR SALE: For-A monochrome TVT typewriter (VTW-100 caption generator) and matching on-screen pointer (controlled by joystick). These are low-end broadcast items, for 625-line system. Both clean and working. £50 the pair from *Tony Clayden 020-8361 8881*

Books: - ITV ANNUAL 1964. ed Huw Thomas. Nice pictures of ITN, Fireball XL5, studio scenes, Pye cameras. Spine paper missing. £3.

UNDERSTANDING TELEVISION. Ed. Robert Hilliard. Hastings House 1964. Many photos of tv equipment-vt-mics-cameras-lights from the period. A USA 'How to' book. £8

TELEVISION: The First 50 years. Geddes/Bussey. 1986. Well illustrated booklet produced by the National Museum of Photography, Film & Television. £5

TELEVISION ENGINEERING Vol 2. Amos/Birkenshaw. iliffe Books. Mint copy with d/w. £6

UNDERSTANDING TELEVISION. John Howkins. Sundial Books 1976. Large format, well-illustrated sections including 'Upstairs-Downstairs', ITN,

History of TV etc. £5

INDEPENDENT TELEVISION IN BRITAIN. Bernard Sendall. 1982. Vol 1. Origin & Foundation 1946-1962. How ITV began. Invaluable history for the TV scholar. £10

GIRL FILM & TELEVISION ANNUAL No1 1957. No d/w. £6. 1st of this attractive series

FANTASTIC TELEVISION. Gerani/Schulman. Titan Books 1987. Lots of US/UK fantasy tv shows listed. Illustrated. £3

MAGPIE ANNUAL 1973 & 1974. £1 each

All VGC. Postage minimum on all items £1.50

Contact *Dicky Howett. 01371 820155, Email: [dicky.howett@btinternet.com](mailto:dicky.howett@btinternet.com)*

Barco CRM51 Colour monitor £50, Studer B62 Half track stereo tape deck with some tapes £75, Kingshill variable psu O-50v @ 5amps twice 19" Rack mount, metered £40, Nagra 1V-S Half track portable tape recorder offers!! Contact *Ray Hill on 01989 762839, email [RAYandNEIL@rayhilltv.freeseerve.co.uk](mailto:RAYandNEIL@rayhilltv.freeseerve.co.uk)*

Sony HVC 2000 colour camera, Pioneer PX7 Genlock computer (MSX), Toshiba HX10 computer (MSX), Toshiba disk drive and DM printer for same, 14in RGB Cub monitor, 24cm aerial 28 element G3JVL, 24cm "Fred Smith" 39 element aerial, BATC Mk 2 receiver PCB, module and i/c sound chip, all new or as new.

Monitors: 9in (6), 12in (3) b/w, all external sync. Door phone monitors (3) new, good viewfinders.

75m x H100 cable, new. 22in Mk3 studio colour monitor, Safgan DB scope (intermittent fault), TVT 432 70cms vision TX, Sanson HD tripod, TS 129V HF rig with 100W amp., Kenwood TR7600 2M rig, external camera housings (2).

CQ-TV mags 60 to date, some earlier, and various handbooks.



No reasonable offers refused. Can deliver in midlands or Wales if required (cymraeg os oes cyfle!) **Contact Bryan**

**Dandy, G4YPB, 8 Woodbury Park, Holy Heath, Worcester, WR6 6NT. Tel 01905 620616**

## Wanted

Instruction book and service manual for a Sony U-Matic, model VO-7630. **Contact Dave Hazell on 01793 765390**

one. **Contact Ray Hill on 01989 762839, email [RAYandNEIL@rayhilltv.freeserve.co.uk](mailto:RAYandNEIL@rayhilltv.freeserve.co.uk)**

PYE Mk 3 viewfinder hood plus a VAROTAL 5 ZOOM LENSE or other long types. Also wanted, U-matic portable tapes 30 minutes length. Clean or new condition. I know that there's at least one of each of the above listed hiding away in BATC land. All calls answered in strictest confidence. Cash offered to those of a nervous disposition. **Contact [dicky.howett@btinternet.com](mailto:dicky.howett@btinternet.com) or ring 01371 820155**

Wanted: Service manuals/technical info or what have you for the following gear. Cossor 1035 MK 3 scope, Tektronix 502 scope, RCA Audio Chanalyst type 170a, Telequipment 405 line pattern generator type WG4, HP 412A Valve Voltmeter type 412A. and for the following 1/2" EIAJ VTR's Panasonic NV3160 and NV8030. also require a curcuit for a Marconi (KB) picture monitor type BD851 (have already tried the BATC library for this one). Is alleged to have come from the KB museum. If you can help please **contact: Terry Martini on: 0207 702 8774 or Email: [audiovisual@callnetuk.com](mailto:audiovisual@callnetuk.com). Snail mail to: 122b Cannon Street Road, Whitechapel London E1 2LH**

WANTED View finder for Hitachi FP-Z31E also lens and cables for same camera Information required for ROLEC PMX62 audio mixer and power supply or circuit details to build

Wanted: Does anyone have any information regarding converting a 9" Sony RGB veiwdata terminal monitor, model No KTM-1000UB (Viedotex Terminal KTX-1000UB) for use with the Amiga computer, I have the correct connection plug and diagram. I would be most grateful for any info. **Contact George Mayo. G4EUF on 01530 242378 or e-mail: [george.mayo@virgin.net](mailto:george.mayo@virgin.net)**

Tube wanted for JVC Camera Model GX-N5E. Tube type Matsushita 4077c. QTHR. **Contact Brian Alderson, phone 01609 772702. e mail [m3kix@free.uk](mailto:m3kix@free.uk)**

## Index of Advertisers

BATC advertising rates .....	7	HS Publications.....	33
BATC Publications.....	19	Members Services .....	19
Confidential Communications Ltd .....	40	Members Services Sale .....	17
GB3XT Kits and Bits .....	9	'Repeater' magazine.....	40
GH Engineering.....	46	S. Marshall .....	33