

Contents

Contents	1
Committee Contacts	2
Editorial.....	4
Licensing and Other News - May 1998.....	5
High Performance ATV Transmitter for 13cm.....	7
NBTV rediscovered	17
A Personal Memory of the early days of Television	20
The Ravensbourne Solution.	26
Low Cost Programmable Video Callsign Generator	30
ATV at the Sandown Model Symposium May 9-10, 1998	37
Photographing the TV Screen	40
That was the Rally that was.....	43
An American's impressions of the 1998 BATC Rally	45
Deadline	46
BATC Publications	i
Members' Services.....	iii
Setting Vision Deviation.....	47
NBTV Pattern Generator Mk 2.....	49
Sarnoff on Television.....	53
Early Photicon Camera.....	57
TV on the Air.....	60
Auto Etch, an automatic etching bath.....	63
Memories of Alexandra Palace	69
Satellite TV News	70
Circuit Notebook No. 64.....	75
In retrospect	79
Forward reading signal meter for the TVRO3, Dove RX/IF units.	80
How we (nearly) played ghost on Auntie.....	81
Post and News	85
For Sale	87
Wanted.....	92
Index of Advertisers.....	92

Edited by Ian Pawson, circuits drawn by Allan Robinson, proof read by Peter Delaney. All rights reserved, all wrongs denied.

© 1998 by the BATC.

Printed by *Cramphorn Printers Ltd.*, 15c Paynes Lane, Rugby, CV21 2UH, England

Committee Contacts

BATC Chairman: Trevor Brown G8CJS

Club affairs, Video tape library, Technical queries, especially relating to handbook projects. 14 Stairfoot Close, Adel, Leeds, LS16 8JR. Tel: 01132 670115. E-mail: chairman@batc.org.uk

BATC General Secretary: Paul Marshall G8MJW

General club correspondence and business. Library queries relating to the borrowing or donation of written material. Fern House, Church Road, Harby, Notts., NG23 7ED. Tel: 01522 703348.
Email secretary@batc.org.uk

BATC Hon. Treasurer: Brian Summers G8CQS

Enquiries regarding club finances, Donations, and constitutional enquiries. 9 Prior Croft Close, Camberley, Surrey, GU15 1DE. Tel: 01276 677879, Mobile 0850 014892 Email: treasurer@batc.org.uk

CQ-TV Magazine: Editor Ian Pawson

Anything for publication in CQ-TV, Articles, Review items, Letters to the editor, and other material except as below. 14 Lilac Avenue, Leicester, LE5 1FN, England. Tel: 0116 276 9425 Email: editor@batc.org.uk

Photographs for the CQ-TV covers:- Please send any photographs by post, electronic images by email, to the editor at the above addresses.

TV on the Air:- Graham Hankins G8EMX, 11 Cottesbrook Road, Acocks Green, Birmingham, B27 6LE. Tel: 0121 707 4337

Satellite TV News:- Paul Holland G3TZO, Chatterton, Chapel Lane, Thrapwood, Nr. Malpas, Cheshire, SY14 7AX. Tel: 01948 770429, Email: satnews@batc.org.uk

CQ-TV Advertising Manager: Chris Smith (G1FEF) 35 Pytchley Road, Rushden, Northants, NN10 9XB. Tel: 01933 777385 Fax: 01933 777577. Email: adman@batc.org.uk

CQ-TV Awards:- Bob Webb G8VBA, 78 Station Road, Rolleston on Dove, Burton on Trent, Staffs., DE13 9AB. Tel: 01283 814582

Exhibitions

Mike Wooding G6IQM, 5 Ware Orchard, Barby, Nr. Rugby, CV33 8UF.
Tel: 01788 890365, Fax: 01788 891883, Mobile: 0860 857434
Email: rally98@batc.org.uk

Club Sales

Members Services:- PCB's, components, camera tubes, accessories, etc. (NOT PUBLICATIONS). Peter Delaney G8KZG, 6 East View Close, Wargrave, Berkshire, RG10 8BJ. Tel: 0118 940 3121

Publications:- Handbooks, Back copies CQTV, and anything related to the supply of BATC publications. Paul Marshall, Fern House, Church Road, Harby, Notts., NG23 7ED, England.

E-mail: publications@batc.org.uk

Membership

Anything to do with membership, including new applications, queries about new and existing membership, non-receipt of CQ-TV, subscriptions, membership records, data protection act. Dave Lawton G0ANO, 'Grenehurst', Pinewood Road, High Wycombe, Bucks., HP12 4DD. Tel: 01494 528899. E-mail: memsec@batc.org.uk

Club Liaison:- And anything of a political nature, co-ordination of ATV repeater licences. Graham Shirville G3VZV, The Hill Farm, Potsgrove, Milton Keynes, Bucks., MK17 9HF. Tel: 01525 290343. E-mail g3vzv@amsat.org

Contests:- Richard Guttridge G4YTV, Ivy House, Rise Road, Skirlaugh, Hull, HU11 5BH. Tel: 01964 562498

BATC BBS Sysop:- Brian Kelly GW6BWX, 12 Cotswold Way, Risca, Gwent, NP1 6QT. Tel: 0410 279606. E-mail: bbs@batc.org.uk *Please note that the BBS is currently 'off the air'.*

Repeater Liaison:- General enquiries and repeater affiliation. Graham Hankins G8EMX, 11 Cottesbrook Road, Acocks Green, Birmingham, B27 6LE. Tel: 0121 707 4337.

BATC web master

Anything to do with the BATCs web site. E-mail: webmaster@batc.org.uk

Does size matter?

For many years, CQ-TV has been produced as an A5 (149mm x 210mm) sized book, however, nearly all other European ATV magazines are A4 (290mm x 210mm) sized as are all commercial publications. Your committee has been thinking of changing CQ-TV to an A4 sized format.

From a production point of view, the costs would be slightly less, as fewer printing plates would be needed. As most page layout and word processing software is geared to the A4 page size, so, from an editorial point of view, it would make production of the magazine simpler. One of the main problems with the A5 size is trying to fit circuit diagrams onto such a small page. Moving up to A4 would greatly increase the readability of these diagrams. (Have a look at page 15 for an example of what I mean.)

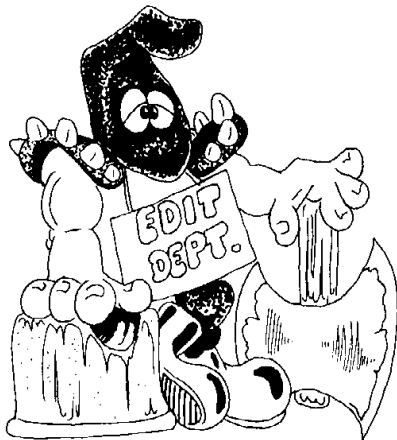

CQ-TV is your magazine. It is produced for you, our members, and not for any commercial purposes, so your opinions, if you have any, on this matter to us. If you feel strongly about this size issue, either way, then please write or email to the chairman whose address can be found on page 2.

The BATC CD.

As the last 3 years CQ-TV's have been produced in electronic format, we have put these together (173 to 183) on a CD in both Word97 and Adobe Portable Document (.pdf) format. The CD also contains both 16 and 32 bit versions of the Word97 viewer and the Acrobat reader version 3, with the word text search plugin enabling a full word search of ALL the included documents..

There is also a full copy of the BATC web site and the Internet Explorer v4.01 web browser. There is over 500M of software of interest to the TV amateur. The CD costs £5.00, including UK postage, and it is available from the publications department.

Ian Pawson - Editor.

Licensing and Other News - May 1998

By Graham Shirville, G3VZV

Firstly some up to date news about recently licensed repeaters and current applications!

23cms band

- GB3AD in Stevenage has now been approved – contact G0OVO for details
- GB3VX near Eastbourne has now been approved – contact G1IFV for details,
- GB3LV in Lincoln is expected to be cleared in the next few weeks - contact G7AVU
- GB3DH in Derbyshire is also expected to finish the licensing process in a month or so – contact G7MKS
- Enfield – a letter of intent has been received from G7DVG for a unit covering the Lea Valley down into the east part of London.

10GHz band

- GB3BG in Sedgley in the Midlands has now been approved - contact G6WJJ for details
- GB3DJ near Telford is also expected to be approved in the next few weeks – contact G4EAB
- GB3RV a unit to be co-sited with GB3VR on 23cms in Brighton - G8KOE is the contact man

Good news/bad news department

There is a proposal coming out of the USA to allocate frequencies in the 1240-1260MHz region to a new generation of Global Positioning Satellites. The plan is for these new birds to provide an even more precise system than the present civilian devices! No doubt a very good idea but unlikely to be compatible with the high power ATC radars that we share the band with. The proposal has been around for a couple of years at least but the USA still seems to be unaware/disinterested in what is using the frequencies outside of their island! Perhaps some of our American readers can get the message across.

At a meeting of the IARU Region 1 "VHF" Managers meeting held earlier this year in Vienna a proposal from DARC (Germany) was discussed. The proposal was for ATV (repeater inputs and simplex) to use a frequency around 2435MHz until such time as any amateur satellites start using that part of the 2400-2450 amateur satellite allocation. The proposal was supported by the RSGB and was accepted.

Therefore it is now technically possible to set up an inband 13cms ATV repeater with input on 2435 and output around 100MHz lower. A number of groups have, I know, thought about such a unit in the past so perhaps now one will come forward to be the first!

Current details of all UK ATV repeaters and applications are available on the web: <http://members.aol.com/rmcweb/rmc.htm> or through a link from the BATC website <http://www.batc.org.uk>

23cm TELEVISION		
INPUT	OUTPUT	REPEATERS
1248 MHz	1310 MHz	GB3VL
1248 MHz	1308 MHz	GB3EY, GB3HV
1249 MHz	1310 MHz	GB3KT , GB3VX
1249 MHz	1316 MHz	GB3AD , GB3AT , GB3DH , GB3ET, GB3GV, GB3LO, GB3MV, GB3NV , GB3PV, GB3RT, GB3TM, GB3TN, GB3TT, GB3VR, GB3WV , GB3ZZ
1276.5 MHz	1311.5 MHz	GB3UT
1249 MHz	1318.5 MHz	GB3TV, GB3UD

10GHz TV		
INPUT	OUTPUT	REPEATERS
10.340 GHz	10.065 GHz	GB3XT
10.315 GHz	10.135 GHz	GB3TG , GB3XG
10.425 GHz	10.135 GHz	GB3BG , GB3DJ , GB3RV

For any more or updated information please contact Graham Shirville G3VZV.

High Performance ATV Transmitter for 13cm

By Ian F Bennett G6TVJ

Here is a design for a synthesised ATV transmitter covering the 13cm band and beyond up to about 2.6 GHz. This transmitter has been designed for optimum video performance and can achieve a broadcast quality signal when



received with a professional TV microwave receiver. The design is based around a commercial voltage controlled oscillator (VCO) which forms the heart of the transmitter. This unit allows for the complete absence of RF alignment requirements and also aids the construction and reproducibility of the design. The transmitter also makes use of a commercial power amplifier module made by Down East Microwave producing about 1.6W. The transmitter exciter could be operated on it's own if required and produces about 50 mW.

How it works

The microwave signal is initially generated by a VCO made by Z-comm. This company produces a wide range of VCO products and so the one chosen meets our requirements very well. The module tunes about 2.2-2.7 GHz and provides an output of about +10 dBm. The unit can almost be considered a little TV transmitter in it's own right. The tuning voltage input spans about 1-10V and has very low capacitance and so accepts high frequency video modulation with ease. The VCO is very stable as it was originally designed for narrow band applications, it also simplifies the design of the transmitter considerably. A colleague of mine has built a miniature TV transmitter using one of these units and an amplifier which measures just a couple of inches square.

The VCO feeds two destinations via a 3 dB attenuator and a resistive splitter. Z-comm recommend this approach as it improves the isolation of the VCO and prevents it from "pulling" with changing load. The splitter is

High Performance ATV Transmitter for 13cm

made up of three 18R resistors and so provides further loss and hence isolation. One output of the splitter feeds a VNA 25 mmic amplifier which brings the level from about 0 dBm up to about +16 dBm. The VNA 25 is made by Mini Circuits and is a "Very Nice Amplifier". These surface mount units operate on 5V, require no coupling capacitors and work from 500 MHz to 2.5 GHz, they are useful little gain blocks ideal for the 23 and 13cm bands. The VNA 25 is what can be considered the output part of the transmitter exciter.

The second output of the splitter feeds a Plessey SP4982 divide by 8192 prescaler IC. The IC provides the synthesiser with a signal divided down from the transmitter output frequency, producing a value of about

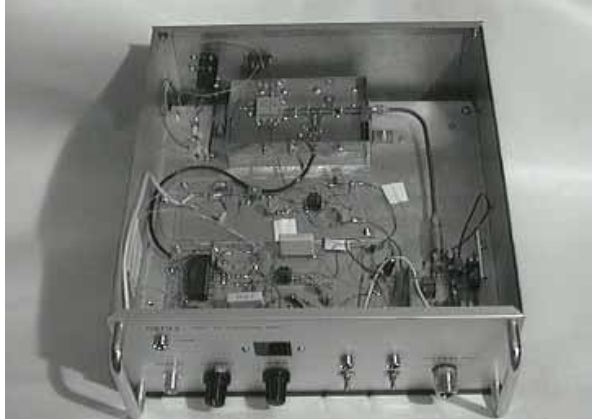

280 kHz. The divided transmitter output frequency can be monitored at this point. The 4982 is a consumer device rated to about 2.5 GHz but has worked successfully to about 2.6 GHz with no problems. The device is driven with about a milliwatt that helps extend its frequency range.

Synthesiser

This transmitter uses the Motorola MC145151 CMOS parallel synthesiser IC. This device is extremely useful as it is programmed with parallel data and so does not require the use of microprocessors to communicate with it. It is my favourite IC and undoubtedly a classic, I have built endless synthesisers with it from H.F. to this frequency, it is also useful in ATV for use with sound subcarriers. I have fitted one of these chips to the Aztek transmitter in our repeater GB3ZZ.

Most other ATV transmitter designs use a Plessey SP5060 synthesiser, these devices can provide good results but in most cases the loop filter characteristics are inappropriate for FM TV modulation. Everyone follows the Plessey handbook that specifies a network that is intended for use with a frequency-doubling mixer not a TV transmitter. The video low frequency response is ruined by the network and it can lead to rolling and tearing pictures, particularly in difficult circumstances like working through repeaters, working long distance or through long chains of video

equipment. Only one transmitter breaks with tradition and is the only one which I could recommend. The G4WIM unit sold by Tim Forrester addresses this problem and uses a MC145151 synthesiser and a different filter network. The transmitter appeared in CQ-TV 165 in February 1994. I have one of these and it gives excellent results.

The MC145151 can be tailored more exactly to the requirements of video modulation. Incidentally the 151 is about the same price as an SP5060 excluding the extra cost of the prescaler.

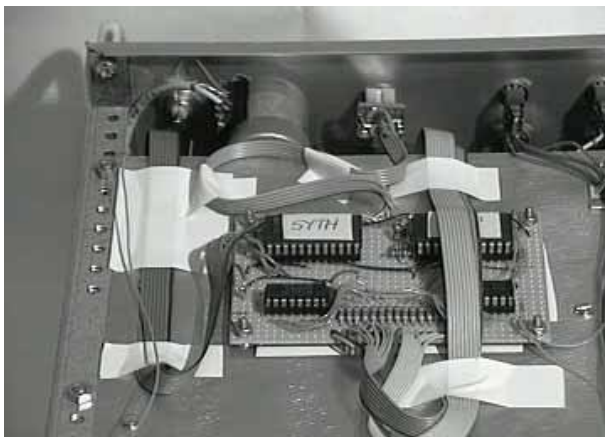

The MC145151 further divides the transmitter signal down to a discriminator frequency, the amount of division inside the IC is programmed by switching of its pins - anything from a divide by 3 to 16383 is possible. This feature allows us to tune the transmitter in steps. A 5 MHz crystal reference frequency is also divided down to the discriminator frequency by a fixed amount of 1024. The two divided frequencies are compared at the discriminator and an error signal is developed which is used to steer the VCO frequency right back up at 2.5 GHz.

For an output frequency of 2.330 GHz (TV Simplex) the signal is divided by 8192 in the prescaler and divided a further 492 in the MC145151. The division ratio can be changed and programmed from dip switches or an EPROM connected to the IC. This transmitter uses two EPROM's one to drive the synthesiser and the other to drive an LED channel display. If you do all the maths to cover the amateur band, a significant bit changes in the middle of the band which cannot be accommodated with a simple BCD switch. BCD does not decode readily to drive two LED displays so a second EPROM is used here to code convert and produce a display of 1 to 16.

Due to the various division ratios the transmitter step size is equal to the reference frequency of 5MHz. The least significant programming bit is not switched via the EPROM so the step size increases to 10 MHz. A -5MHz switch could be fitted to the LSB.

An op-amp and a capacitor network filter the error signal from the MC145151.

It is this network which affects the video signal in a number of ways. The discriminator frequency, if present at the error voltage connection to the VCO, will cause modulation to appear on the video signal and interfere with the transmitted picture. The transient response of the network must be slow in order that the system does not “See” the video modulation, interpret it as frequency drift and try to remove it from the transmitter output. This is what happens with many SP5060 designs and manifests itself as LF tilt, ramping or distorted field syncs and you know what that leads to!

So how did I arrive at the component values? The Motorola handbook quotes a load of maths that I tried to understand once but with the lack of a decent explanation I found it easier to experiment. I have looked at some commercial designs to get a starting point. The behaviour of the synthesiser can be monitored in a number of ways.

1. The VCO error voltage can be monitored on a scope, an excessive oscillation as the PLL comes into lock will indicate incorrect values.
2. A CW HF receiver can be used to listen to the “pre-scaled” signal as the PLL locks up to further gain the best characteristic.
3. The reaction of the synthesiser to the video signal content using special test signals will also indicate how things are performing. Changes in average picture level will affect the error voltage. Also no LF video modulation should be present on the error signal.

Dual capacitance substitution boxes are very useful here, also ganged potentiometers can be used to ascertain fixed component values.

From cold the transmitter takes several seconds to lock up and will unlock briefly if the channel switch is moved quickly around the channels. The MC145151 has a lock indicator output - this drives an LED. It is possible to use this output via some logic to mute the transmitter output if the PLL goes out of lock.

The network shown operates well with the values stated. The output from the discriminator is a differential signal and this is combined in the op-amp. The critical components are in the feedback paths of the op-amp. Splitting the op-amp inputs and decoupling them to earth increases the filtering and so does adding an extra RC network at the output of the op-amp.

The filtered error signal is combined with a standard pre-emphasised video signal using a video op-amp. The error signal sets the DC conditions of the amplifier and hence the VCO voltage. The video signal is fed to the

High Performance ATV Transmitter for 13cm

inverting input via a small network to slightly correct the HF response as viewed from a broadcast receiver. This arrangement does in fact invert the video modulation, but it comes out OK as viewed via an “S” band LNB that uses a high side local oscillator. For positive modulation an additional video inverter should be placed at the input to the transmitter.

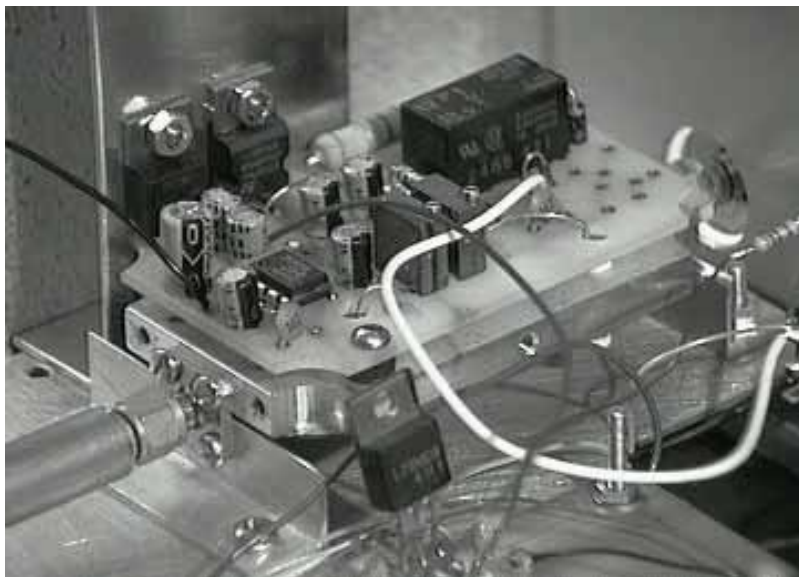

The transmitter boasts no AC coupling in the video path so will produce perfect LF results, something often lacking in other ATV transmitters. It should be noted that the DC component of the video signal is still lost in transmission due to the average carrier frequency shifting with average picture level. The synthesiser will react slowly to the modulation, keeping the average frequency in check. This is a characteristic of all FM TV transmitters and analogue satellite uplink modulators and is not a fault. No attempt should be made to clamp the outgoing signal in the transmitter, video clamps are horrible things and should not be used in transmission chains. All sorts of strange diode circuits, networks and transistor junctions seem to crop up in other designs, only to succeed in stripping off the syncs and crushing the video. As I write another strange circuit has appeared in CQ TV, a peculiar clamp circuit is used to interfere with the action of a synthesiser loop in order to establish a carrier frequency. The circuit is quite complicated and completely unnecessary.

The power supply consists of regulators to supply 10V to power the VCO, 5V to run the synthesiser, VNA, prescaler and channel display. A DC-DC converter is used to supply a negative 12V rail to the op-amps.

High Performance ATV Transmitter for 13cm

A diode in the filter op-amp negative supply prevents the VCO error voltage from going excessively negative in the event of a fault condition. A negative bias to the VCO could possibly damage it, as there would be a forward biased varactor diode inside it. A clamp diode at the video op-amp output also protects against this condition.

The video circuitry is simply a CCIR 405 pre-emphasis network and a pot to set the deviation.

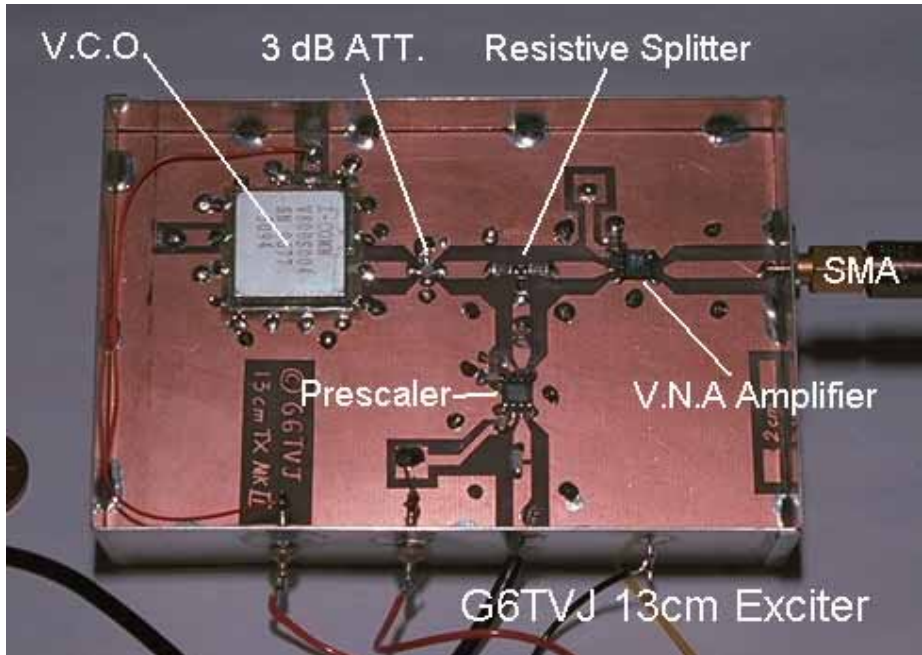

Power Amplifier

A commercial two-stage power amplifier supplied by Down East Microwave is used to provide a transmitter output of about 1.6W. I found this unit while searching on the Internet and it is available for about \$200 and \$15 postage. This two-stage amplifier comes as a ready built module un-enclosed, complete with a negative bias PCB and transmit relay. The output from the exciter is attenuated by 3dB to give the recommended drive level to the power amp and provide some isolation from the exciter. The unit is rated flat out at 2W but I couldn't get that out of it. To be fair it is actually rated from 2.3 to 3.4GHz (To cover 9cm) so I am using it at the bottom of the band, it may "Hot up" as you go higher. The amplifier is very stable and no instability problems were encountered even though both the P.A. and the exciter are not completely screened from each other.

Construction

The transmitter is built in several parts. A SHF module supports the VCO, prescaler, VNA and associated microwave circuitry. The devices are interconnected using 50R micro-strip lines etched onto ordinary double-sided fiberglass board. All the SHF devices are of surface-mount construction. I have designed a double-sided PCB layout for the SHF bits - the PCB mounts inside a tinfoil box in a Microwave Committee style. All the other low frequency stuff can be mounted as convenient, as long as due attention is paid to the usual grounding and decoupling. I build most circuitry using special prototyping sticky back pcb pads called "Wainwright Mini-Mount". These are extremely useful and allow very speedy development of circuitry by sticking them down onto a pcb ground plane. The EPROM's can be built on to vero board together with the two 4511 display driver ICs.

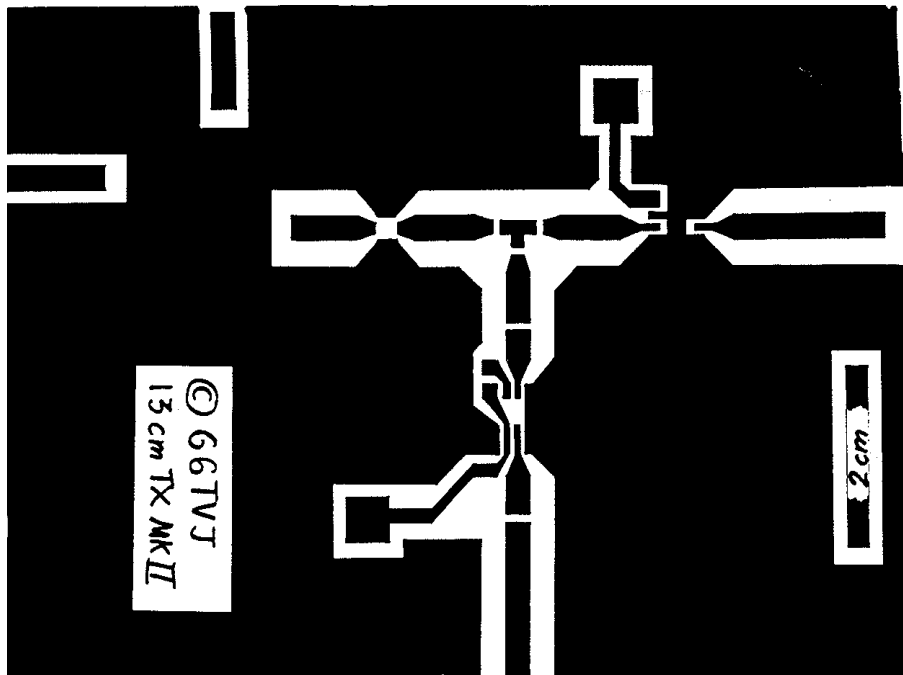

PCB layout (not actual size)

A little imagination is needed with the Power Amp - it can be supplied in a box but that costs another \$100. I mounted it SHF side down using brackets screwed to two unused holes on it's SMA terminations. The

High Performance ATV Transmitter for 13cm

aluminium body of the power amp ideally needs some extra heatsinking, by screwing a plate to it.

Operation

I have operated the transmitter on 2.330 GHz and it has provided excellent P5 results kindly sent back to me on 23cm by Phil G1HIA. The transmitter is mounted in my loft space away from the shack to keep the feeder lengths to an absolute minimum. The P.A. is keyed remotely from the shack but to change frequency I will have to climb a ladder! A sound subcarrier was inserted down in the shack and fed up the video cable to the transmitter. With this arrangement a full duplex high quality QSO was possible.

The transmitter can be tuned up into a frequency allocation used for broadcast video links. This feature has allowed me to test the transmitter into a broadcast receiver operating at 2.460 GHz (known as channel 1) via a path simulator. By passing various test signals through the transmitter the performance can be assessed by looking at the received output on a scope. Passing a 50Hz square wave through the TX revealed no LF distortion at all. A square wave is not an alien video signal as it closely mimics an outdoor scene with half sky half land. The HF response was measured using a calibrated "Pulse & Bar" signal, the result was close to 100%.

I am cheating a little in claiming broadcast performance from a home built transmitter.

Getting or approaching a broadcast quality signal from a transmitter is not that difficult, the tricky stuff is in the receiver. In a receiver you have bandwidth defining filters, demodulator performance and group delay characteristics which all have to be compensated and corrected for. Getting a picture from A to B is easy, getting it from one end of the country to the other combined with decodable Teletext and sound-in-syncs is not so easy, hence the complexity of broadcast designs.

Conclusion

The transmitter is not particularly complicated and it demonstrates the possibilities for amateur equipment. If you want rolling tearing pictures then insert a 47uF capacitor in series with the video signal. Maybe amateur signals aren't amateur if there aint a little wobbly, but a noisy but undistorted video signal will lock a monitor at only P1! This design can be used at 23cm with no mechanical alterations to the PCB layout and would be ideal for where the best possible quality is required i.e. a TV repeater output.

G6TVJ 13cm ATV TRANSMITTER MKII

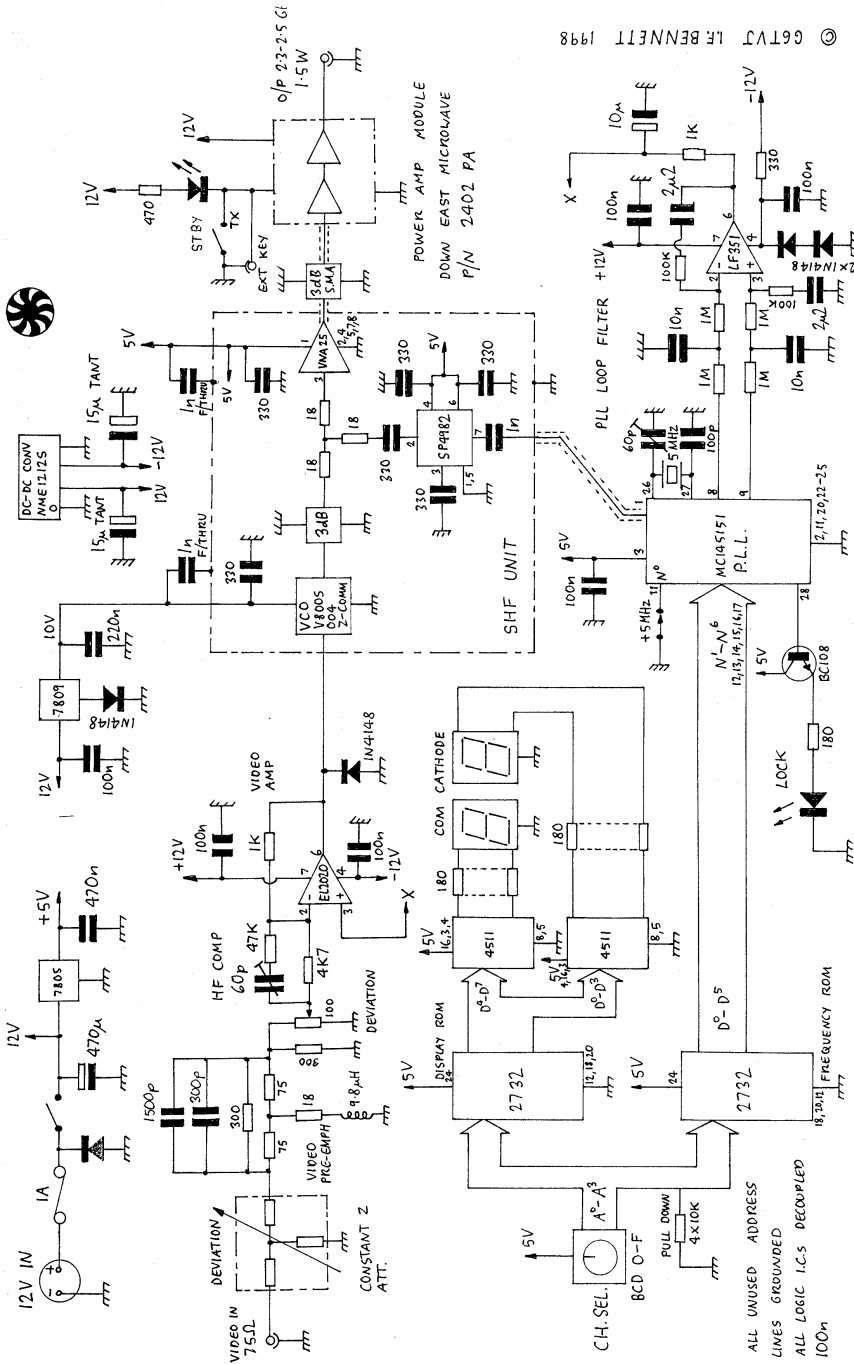

High Performance ATV Transmitter for 13cm

If you have the appropriate licence then the transmitter could be used outside the amateur band.

Component Suppliers-

V800S004 VCO form Z-comm Eurosource Electronics Ltd, 0181 568 3332.

Plessey SP4982 from Gothic Crellon 0118 978 8878

VNA 25 and 3dB att. from Mini Circuits Europe 01252 835094

Down East Microwave 908-996-3584 (USA)

www.downeastmicrowave.com

Wainwright Prototyping System from Wessex Electronics 0117 9571404

Frequency EPROM Programming

CH.	Frequency	Add.	Data(Hex)	CH.	Frequency	Add.	Data(Hex)
1	2.320 GHz	0	28	9	2.400 GHz	8	30
2	2.330 GHz	1	29	10	2.410 GHz	9	31
3	2.340 GHz	2	2A	11	2.420 GHz	A	32
4	2.350 GHz	3	2B	12	2.430 GHz	B	33
5	2.360 GHz	4	2C	13	2.440 GHz	C	34
6	2.370 GHz	5	2D	14	2.450 GHz	D	35
7	2.380 GHz	6	2E	15	2.460 GHz*	E	36
8	2.390 GHz	7	2F	16	2.500 GHz*	F	3A

* Not for Amateur Use

Display EPROM Programming

Add.	Data	Add.	Data	Add.	Data	Add.	Data
0	01	4	05	8	09	C	13
1	02	5	06	9	10	D	14
2	03	6	07	A	11	E	15
3	04	7	08	B	12	F	16

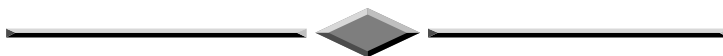

WANTED

John Logie Baird letters, Motorola GP300 radios *Contact: P. Bedford 0181 747 0069*

NBTV rediscovered

By C. Grant Dixon

I am sure that most of you will know that the first person to produce a workable system of television was John Logie Baird and his 30-line pictures were broadcast between 1929 and 1935. The NBTV signal is an audio tone with frequencies having an upper limit well within the hearing range of an average person and so it was possible to record television on a disc with equipment that was available at that time. Only one disc, of still pictures, was ever marketed, though Baird had recorded test images in the 1920s for his own test purposes.



There was at least one firm selling recording apparatus to the home user under the name of "Silvatone" and it is not generally realised that discs of television pictures cut by enthusiastic amateurs, and possibly professionals also, are in existence at the present time. One such disc was found in a garage with the legend "Television" on it and a date in 1933. It was an aluminium disc, somewhat corroded, but in view of the tremendous historic interest Don McLean and Eliot Levin set to work and managed to extract a TV signal from the disc. Corrections were needed to compensate for deficiencies in the cutter head and general recording noise but eventually Don managed to display a moving picture of a line of chorus girls. Subsequent research in the BBC archives revealed that it was the Astoria Dance Troupe.



Offscreen photo published in "Television" in 1934.

Still pictures do not do justice to the 30-line TV and you would be well advised to visit Don's site on the Internet where a short moving picture extract is available. <http://www.dfm.dircon.co>

Don was interviewed on the "Tomorrow's World" programme and his pictures were displayed there.

Quite recently a further set of recordings, belonging to Jon Weller, has come to light and Don has got some new pictures on his web site, the most interesting of which is almost certainly Betty Bolton, a well known singer of that period who was born in 1906 and is still alive in 1998. In addition to this and other short

extracts from the discs Don has put on his site a full 55secs from the Betty Bolton recording which has to be viewed with the "Real Video" Player.

The recording of the Astoria Dance Troupe is the earliest dated off-air recording of a broadcast television programme. These other recordings which have recently been discovered do not carry any dates, but are obviously from the same period.

Don McLean would be very pleased to hear of any other recordings which may be lying forgotten in somebody's attic; he also wishes it to be known that he holds the copyright for all these restorations.

Further information and news of NBTV activity can be obtained by visiting <http://homepages.wyenet.co.uk/gdixon/index.html>



Publicity Photo of the period



Contemporary publicity picture

GB3XT KITS & BITS

NEW DOVE TUNEABLE IF / RX KIT.

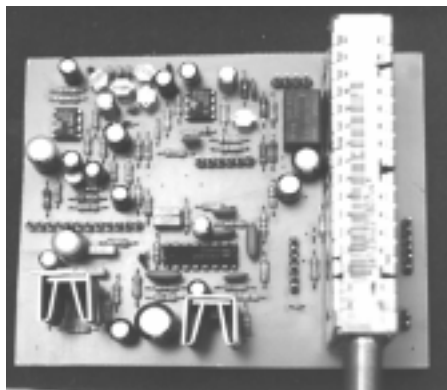

The Dove ATV Tuneable IF./ RX. forms the ideal heart of an ATV receiving system for either 24CMs (pre-amp recommended) or the higher bands when used in conjunction with a suitable Low Noise Block converter.

The flexible design concept allows for expansion to suit your needs for now and the future.

Easy to construct requiring no adjustment, setting up or alignment. The kit contains all board mounted components and full instructions.

Brief spec. Size.105mm wide x 97mm deep x 50mm high. Power. 12vDC @ 400mA. Frequency range. 925MHz - 1800MHz. Audio subcarrier. 6MHz. Video bandwidth. Variable.

Video outputs. 1v PK/PK + Base band. Audio output. 1.5Watts. Controls. (all 10K pots) Main tuning, Volume, Video gain, Video bandwidth. LNB power on/off switch.

DOVE RECEIVER KIT £42.00 all-inclusive.

GUNNMOD2 3CMs ATV. TX. kit. Very popular full feature Gunn diode TX. Complete with pre-tuned oscillator head. £30.00. PCB. kit less oscillator head £20.00

3CMs LNB's. All with 9GHz Local oscillators. New 0.7db nf. with dish feed horn. £43.00. With 22mm circular W/G input £45.00. Others and second hand units available. Please contact.

WG16 to 22mm Circular transition. Converts 22mm circular to WG16 and vice versa.

24CMs LOW NOISE HIGH GAIN GASFET PRE-AMP kit. 40db gain 1db NF. band pass helical filtering. 12-18vDC feed via co-ax. Designed specifically for ATV. but good for all modes £60.00

DTMF DECODER kit. Very high quality decoder IC. All o/p's buffered. Will directly drive TTL/CMOS or relays. Can be used to control whatever your imagination thinks of. £12.00

Prices are all inclusive of P&P etc. (+ 10% abroad) PCB's are available assembled and tested at extra charge. **SAE. (to take A4 paper) for further details or call.**

Orders and enquiries to:- BOB PLATTS G8OZP. 220 ROLLESTON ROAD. BURTON UPON TRENT. STAFFS. DE13 0AY. PHONE 01283 531443 7 - 9PM WEEKDAYS PLEASE.

A Personal Memory of the early days of Television

By R.W.Johnson.BA., FIDiagE.

My interest in Television dates back to 1938 when I was 11 years old. An old-fashioned Radio Shop owned by a 70 year old man named Louis Savarios (Not sure how the last name was spelt) fascinated me. To me it was a "Magic Shop" and most unlike the usual retail wireless shops. There were coils, crystals and catswhiskers, variable capacitors, pea lamps and loudspeakers of ancient design. One, I recall, looked more like a small brass Sousaphone.

On the counter of the shop I found several used magazines with technical articles and circuits of Television receivers using valves and cathode ray tubes. I remember pouring over them trying to understand how they worked. I think the timebases were three valve Puckle circuits. I had already

started to build a 30 line T.V. from an old Hobby's magazine and had even thought of displaying the picture on a translucent screen - it never would have worked, but it would have been fun trying - and then I found that 30 line TV was not being transmitted.

The 2nd W.W. intervened and I was evacuated to Frome in Somerset. After returning to London in 1940 my family home was destroyed by bombing and we moved back to Essex where I finished my education at a Grammar School in Grays. I think that most of us surviving the bombing, pilotless bombs and rockets suffered for years with 'Post traumatic stress disorder' and a legacy of anxiety. Bill Evans, mentioned later, was rescued from a collapsed house and still has several inoperable fragments somewhere in his head.

I joined Marconi's in Chelmsford straight from school in 1943 at the age of 16. I tested lots of components and units used in military equipment, but



The Author in 1953, the year before he joined the BATC

finished up there testing airplane ignition harness for the Rolls Merlin, Centaurus and Centurion engines. I left Marconi and volunteered to join the RAF for 8 years to teach and to work on ground radar installations. I was attached to the United States Air Force in 1952/3 for further electronics training.

Years later I returned to Marconi to test a variety of TV equipment. One of these was the Mk1 Sync Generator, which used USA type Octal based valves. I was never sure whether the Mk1 was manufactured before 1939 or after 1945, but they were bought cheaply by China or Hong Kong to start their television service about 1959.

I never saw the Mk2 or Mk3 Sync Generators but assume that they were already in use somewhere. There was also the Mk4 Sync Generator which used the all glass 7 pin valves in exchangeable binary counter modules. The advantage of the Mk4 was that it could overcome the temporary loss of frame sync that occurred during switching between cameras and studios. The wide band moving up the screen had in the past caused some annoyance. I recall that once the Mk4 was in service you could just about see an indistinct aberration moving up the screen but only if you looked carefully. However the BBC returned the Mk4 for further testing because some unexplained spikes were appearing on the monitors. I assume that the problem was resolved before these sync generators went into service.

One piece of test equipment that I remember was the Sin² Pulse and Smoothed Bar Generator used for testing video amplifiers. It was designed by someone with the unforgettable name of Stanley Matthews – he was not the famous footballer. I met him again in 1966 while he was working at Mullards in Southampton and I was a visiting Senior Service Engineer fixing problems on their computers.

When the war ended and Television restarted I saw an early 9” Mono TV in one of the small retail shops. My next experience with TV was in the RAF some 90 miles from London when one of my colleagues in 1948 rigged a ground Gee receiver to receive the London transmission, using one timebase from the equipment and the other from an oscilloscope. There was no sync and so we both had to adjust the fine controls to steady the picture. The display tube was a green VCR 97. It was during this period that I met a Ham G3DXO and also I rigged up a Morse key and phones so that I could send Morse to another NCO who was preparing for his Ham License Exam. He was George Glover who passed and became G3FMQ. I was never sufficiently interested in Amateur Radio in those days.

I used another VCR 97 in 1952 to build a TV when I was posted to Stafford. The transmitter was at Lichfield and my receiver was a TRF using EF50 valves. Unfortunately my married quarters were struck by

A Personal Memory of the early days of Television

lightning destroying the chimney, roof, aerial, holing the copper pipes in the airing cupboard, damaging the co-ax cable and the TV and ruining some of the furniture. The house was temporarily covered with a large tarpaulin until repairs were arranged. I was told much later in confidence by a friendly MPBW (Ministry of Public Buildings and Works) civilian that the Station Commander, etc., were attempting to blame me for the damage to the married quarter because I had installed an aerial and that they intended to make me pay for the repairs. Fortunately for me that never happened.



Dagenham Town Show 1957.... The back of the authors head

I believe that it was about 1954 when I first joined the BATC. After leaving the RAF I became involved with the Romford BATC group run by Doug Wheele of the Post Office Telephones. His pleasant and capable wife provided us with refreshments during the club meetings. Later I met some of the PYE group from Cambridge and Jeremy Royle. (Related to Royle Printers who provided TEST CARDS.)

Pictures in CQ-TV 173 showing 'Matilda' brought back memories of the BATC exhibit at the Dagenham Town Show (1957?) where I first saw 'Matilda'. It was used for 'Outside Broadcasts' providing snowy pictures of the surrounding district. The cameraman's task included pointing the

aerial back towards the exhibit marquee. No mean task standing on top of 'Matilda' rumbling along the roads while operating the camera. Disaster almost occurred on Matilda's return to the showground for the camera and cameraman were tangled up in the overhead bunting and cables. Fortunately, the driver stopped just in time to avoid damaging the camera. (The cameraman was considered to be expendable!)

In the Marquee were several 21" and 17" monochrome television receivers which I had persuaded the Philco Company at Hainault to loan to use as monitors. In the enclosed photos you can see the notices, Amateur Television, Romford Group and G2WJ/T and a partly obscured notice on the extreme right 'ROVing MATilda'.

On the same photograph at the centre left you will see three men in close proximity. The man with the light coat, spectacles and balding head was, I believe, an enthusiast - name unknown. The extraordinarily backview, handsome man standing to his right was myself, age 31. I had thought of applying to a modelling agency that needed a handsome back-of-the-head model, but somebody suggested that I was too tall and they really needed someone who could also talk out of the back of his head and smile on the other side of his face at the same time! The man close to my right was Bill Evans from Philco, but not a BATC member.

I had arranged for the loan of about 4 isolation transformers and I believe they were used two TV's to each one. However, there were not enough to go round and you may know that the TV chassis in those days could be lethal if you were not careful. Suffice to say, the engineers responsible for hooking up all the equipment managed to get some severe shocks through being careless. The ground was wet so they were lucky to get away without fatalities. The TV's were returned to Philco's safely and undamaged after the show. While Philco's had arranged the necessary insurance for the TV's I thought it prudent to arrange cover for my responsibility in the event that Philco's insurance did not cover me. The cost of the insurance was £1.00! You can see that Philco's got a great deal of free publicity during the show because there were thousands of leaflets and lurid PHILCO adorned carrier bags in bright blue and yellow which visitors took away with them. You can see the various amateur equipment being used at the time displayed on the benches. I recall, that in those days, young Grant Dixon was working on his colour system - but we never met.

At Marconi Chelmsford in 1959 the 3" and 4½" Image Orthicons were tested by a close-knit elite group of testers. I mentioned the Image Orthicon testers because of the comments at the top of page 20 in CQ-TV 181. When ITV started they had a requirement for TV engineers - so they said - and the testers who had been working on these cameras applied for

A Personal Memory of the early days of Television

the jobs. They found to their dismay that ITV wanted them mainly as camera operators and they might only rarely use their technical skills. The salary offered was much higher than Marconi Test so many of them joined ITV. The industry did not want engineers then either.



Dagenham Town Show 1957

As I had spent a large amount of my working life in attending Radio Schools here and in the USA, Technical Colleges, Industrial Technical Courses, etc., constantly interrupted by having to move around the U.K. and abroad, I decided to attempt a degree course with the Open University in 1985. I took both Science and Technology Foundation Courses in the first year with some small difficulty because the tutorials for both were arranged for the same dates and times. However, I succeeded and continued with a succession of Science, Technology, Computer half Credit courses and obtained my BA degree in 1991. I became eligible for a BSc Honours degree by completing a full credit at 3rd level.

To the future, I want to upgrade my computer, fit a CD ROM Drive and Sound Card. Also, there are various CCTV and Test Equipment projects that I have in mind. At the moment I have a problem with sync separation from mixed video because the quick lash-up that I made to use a mono security camera output with a Philips 9" monitor is causing tearing at the

top left of the picture. At my great age, I can only take vicarious pleasure from the transmitting and receiving articles in CQ-TV. I would like to see more items and circuits on the display problems and mixed video enhancements and less of the problems of transmitting and receiving.

In the film, *The Magic Box*, the story of William Friese-Green and his invention of the movie camera, the film ended with him pleading with the movie moguls not to misuse this new technology. His words fell on deaf ears, although, in the U.K. in earlier years the cinema owners built up an appreciative mass audience by self-imposed censorship of material likely to offend their customers, or certain vociferous pressure groups. Unfortunately, as audiences declined with the advent of television, so did the self-imposed censorship.

I do not know if John Logie Baird made a similar plea about his invention of television, but I do believe that it would also have been ignored. A comment about television attributed to C.P.Scott circa. 1932 was, 'Television? The word is half Latin and half Greek. No good can come of it!'

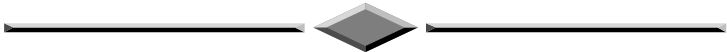

Whilst at the recent Coventry rally I purchased a nice pair of Altai miniature side cutters - made in Taiwan. The accompanying literature delightfully describes other tools in their range as follows:-

MICRO ROUND NOSE PLIERS

With the mill in part of mouth, it can be taken a thing in a mouth firmly

MICRO LONG NOSE PLIERS

Can be used in minute and deeper hole

MICRO BENT NOSE PLIERS

Because of its long tip and curved in 45 degrees the pinchers can be utilised suitably for the complicated working place,

Please keep this well away from Peter Delaney's proof reading department!

John Bales GOHAT

The Ravensbourne Solution.

By Dicky Howett

Dicky Howett enters the Halls of Learning and is given a few lessons about television.

To the average punter, the medium of Television is as easy as pressing a button or waving a camera. The ubiquitous use of the handy camcorder has arguably de-mystified the entire TV process, enabling young or old to appear in multifarious 'home videos'. Similarly, the universal use of the home video recorder (child's play to all children) has democratised the end-user. Programme playing has never been easier, ergo, programme making must be similarly simple? As my aged parent constantly remarks as the end-credits roll, "Why do they need all those people to make a TV programme. I've seen them standing around doing nothing. Even I could do that!" True, but who would watch?

Television is, (and doubtless always will be) a complicated and expensive business. Proper training is essential. Industry veterans may bemoan the fact that TV training is not what it was. The truth is that television training is now considerably more comprehensive, with greater opportunities to work in the medium. But the TV ground-rules have to be firmly established, whether for engineering, script, camera, lighting, sound, or presentation. Once this has been achieved all that follows is (possibly)...
.Art?

Historically, back in the sepia days of British broadcasting, training for the job was firmly ad hoc. Before the war the sole British broadcaster, (BBC radio) had no centralised training department. Producers, engineers or journalists were recruited from outside and then inducted 'on the job'. It was a cost-free and leisurely system which produced many admirable BBC types trained exclusively for the gentlemanly art of Wireless Broadcasting. Television then, of course was but a tiny flicker in the corner.

At the outbreak of the World War II the BBC lost so many technical staff to the armed forces that they had to make up the shortfall by recruiting bodies from the ranks of the relatively unskilled. To cope with this demand, in 1941 a Technical Training Section was started. Training was undertaken at a variety of centres, with instructors working mainly in isolation from one another. Centralisation was inevitable, and in 1946 a BBC Engineering Training Department was established at Wood Norton Hall in Evesham, Worcestershire. The Department dealt with new recruits or staff seeking promotion. Gradually, other areas of training emerged dealing with TV production and film.

Later, during the mid-nineteen fifties when ITV emerged, it was often reckoned that all the new ITV companies had no need to train any of their staff. They simply poached the best ready-trained personnel from the BBC! Records show that the biggest migration of BBC staff was in 1955 when over 500 employees of all ranks deserted the Corporation to work at Associated-Rediffusion, ATV and ITN. The BBC took some comfort in the knowledge that commercial television would never amount to anything more than a ‘Tuppenny Punch and Judy Show’, as Sir Winston Churchill dismissively described it.



Ravensbourne Students at work

The RAVENSBOURNE COLLEGE OF DESIGN AND COMMUNICATION is, arguably, a television training establishment that is top of the range. Situated in a residential area of Chislehurst, Kent, the college was founded in 1962 following an amalgamation of Beckenham, Sidcup and Bromley colleges of Art. Ravensbourne College has been on its present salubrious site since 1976.

Ravensbourne College with its School of Communication department runs a two year HND course, covering a wide range of engineering and programme skills. These include digital technology, vt editing, video systems, programme operations, lighting and audio recording. There is

The Ravensbourne Solution.

also a customised in-house training Short-Course Unit designed for the television industry covering engineering maintenance, camera operation, editing, graphics, sound, lighting and post production. The College's technical facilities are sumptuous (£6 million capital value) and are available to all students.



Graham Lewis, formally of Thames Television is Ravensbourne's engineering Station Controller. He explains, "We have very good manufacturer and broadcaster support. Some of our equipment is on permanent loan, donated or sold to us at a good discount. We have two TV studios, the larger of which at 1450 sq. ft has three BTS 900 CCD cameras plus Vinten peds and even a Heron Mk 3 crane. We plan to convert the smaller studio in collaboration with the Graphics School into a virtual studio. Other equipment available to students includes edit suites with

Beta SF, Avid, Quantel Editbox and Lightworks. Also, we have a fully-furnished engineering laboratory which enables students to learn television engineering principles. Basically we run things here like a small regional TV station. We try to instil into our students the kind of working ethos they're likely to find when they leave us after completing the two year course. Also the sort of standards they can expect to find outside. We like to think it's our 'edge'. The proof of our success is that our students continually find good jobs within the industry, whether in mainstream broadcasting, A/V or Corporate work."

Students at Ravensbourne are exposed to good practice. Every year the College becomes a fully-fledged TV station. On closed-circuit the College transmits its own TV channel by 'shadowing' a terrestrial broadcaster. Called 'Station-On-Air', the idea is to take a clean feed with talkback (via satellite) provided by the broadcaster and drop in College-made commercials or programmes. This real-time exercise gives invaluable experience, working as it does to an exact professional schedule. Throughout the exercise the students (working to a pre-agreed budget-just like in the real world) provide news on the hour, slotting into the schedule like a local opt-out. The news footage, gathered by student news crews is of real events, shot alongside crews from BBC News, Sky or ITN.

Graham Lewis elaborates, "The students had to build here, from scratch, a network control. Last year, for the first part of the day we did something new and linked up via fibre optics with our local cable company, Nynex. The students also used a microwave link for our outside broadcast point at a Bromley shopping centre. The microwave link was loaned to us complete with personnel to set it up! It was all arranged by the students who used their work placement contacts and initiative. Later in the day we reverted to our traditional link with a main broadcaster, in this instance Carlton."

Another good source of student training is tennis at Wimbledon. Graham Lewis: "We own facilities. We regularly provide students as operations staff during Wimbledon Fortnight. There's a news studio equipped entirely by Sony which is used extensively by foreign broadcasters who have their students handle the operational side during interviews etc, arranging the lighting and cameras as required. For this work the students get an expenses-only payment. We must emphasise we don't under any circumstances provide cheap labour here. We make this absolutely clear. For this reason we are in constant touch with both management and unions who understand our objectives."

For more information about Ravensbourne and television training contact; Ravensbourne College of Design and Communication. 0181 289 4900.

Short Course web site www.rave.ac.uk/shortcourses/

Low Cost Programmable Video Callsign Generator

A pattern generator is one of the established sources that can be found in the shack of a ATV'er. Various designs have been published in different magazines, ranging from simple designs to more complicated pattern generators. The pattern generator published here has three characteristics: cheap, simple and programmable. There is also a simple program written for marking and filling in the pixels.

The programmable pattern generator, sometimes also called a video call sign generator, has been developed by the "Zelfbouw Activiteiten Kommittee, Eindhoven", who try to stimulate amateur television by developing reasonably easy circuits. The circuit is based on a design of Dieter Meendermann DCIBP (which was published in UKW Berichte 3/1984) and by the Swevegemse Radioclub ON4ABC. This latter design makes use of modern (and cheap) Philips chips. The callsign generator of "Z.A.K." is actually a combination of both circuits, the most important difference being that 8 different images can be pre-programmed.

Circuit Diagram

The complete circuit diagram of the callsign generator is reproduced in figure 2. The core of the circuit consists of two chips, the SAA 1043, which is responsible for generating the necessary video synchronisation signals, and the TEA 1002 which functions as a digital/analogue converter.

A signal of 4.9 MHz is produced by an oscillator built around IC8. The IC's 9-12 are 4 bit binary counters which are necessary for the addressing of the 128 horizontal picture points. IC4 can address the columns of the picture points. For every picture point there are 4 bits per picture available. The picture is changed by switching over to the following group of 4 bits. For this purpose a diode matrix and the picture multiplexer IC2 has been included. The data stream of the test picture concerned is passed to IC1 by placing an electric potential at the input of the multiplexer; IC5 is a complete sync processor. The synchronisation signals are passed to IC6, which transforms the digital picture information that comes from IC8 and IC3, into an exquisite composite video signal. The complete test picture is at last available on two video outputs via two emitter followers and low pass filters.

More Images

A printed circuit can be supplied by "Z.A.K.", which has to be drilled first. The component layout for this circuit diagram is reproduced in figure 4. Once all the holes have been drilled the components can be mounted.

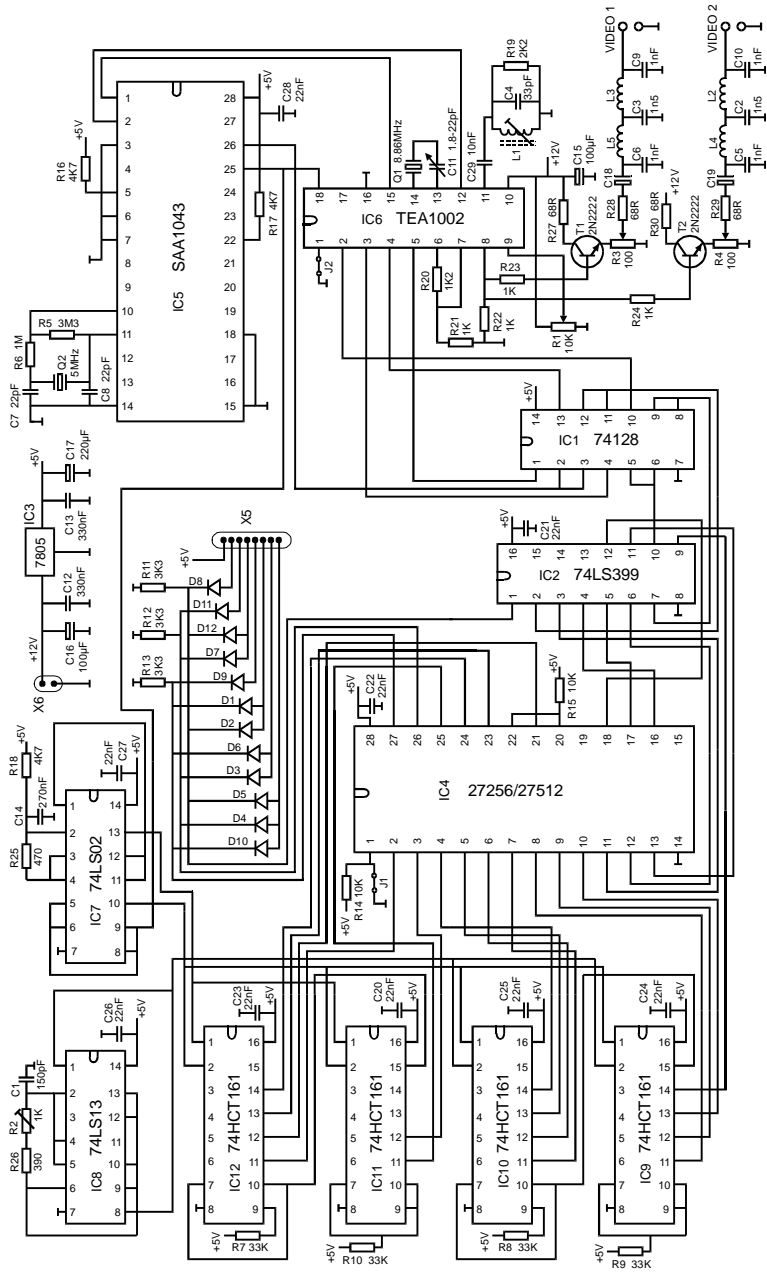
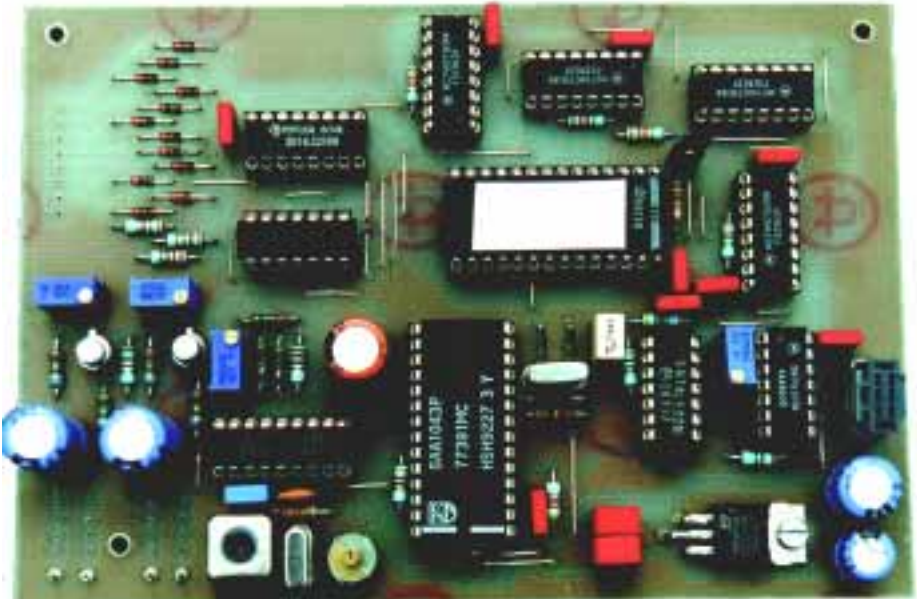

Figure 2

Low Cost Programmable Video Callsign Generator

We start with the various wire jumpers and then the remaining components. The IC's can be mounted in sockets if so desired. Do not mount the R15 yet. This resistor is only of importance if you wish to mount a second EPROM, parallel to the first and you must switch from one EPROM to the other. Jumper J1 has been closed for this purpose. By placing this jumper, you can choose another EPROM and thus another set of pictures. One EPROM can be used for daily use and the other for contests.



The almost completed project

Jumper J2 can invert the colours. The TEA 1002 also produces a bit more colour burst signal. If the inverting buffers in front of the TEA 1002 are omitted (short-circuited) the original signal can, after reversion, again be obtained but with more colour burst. This design assumes that for selection of one of the 8 pictures, an 8-position switch is used. Alternatively the pictures can appear in a continuous cycle. If the switch from diode D1 up to and including D12 and the resistors R11, 12 and 13 are omitted, logic pulses can be fed in at the points where these resistors were connected to the diodes. These pulses may come from a simple logic counter that can easily be built with, for example, an NE 555.

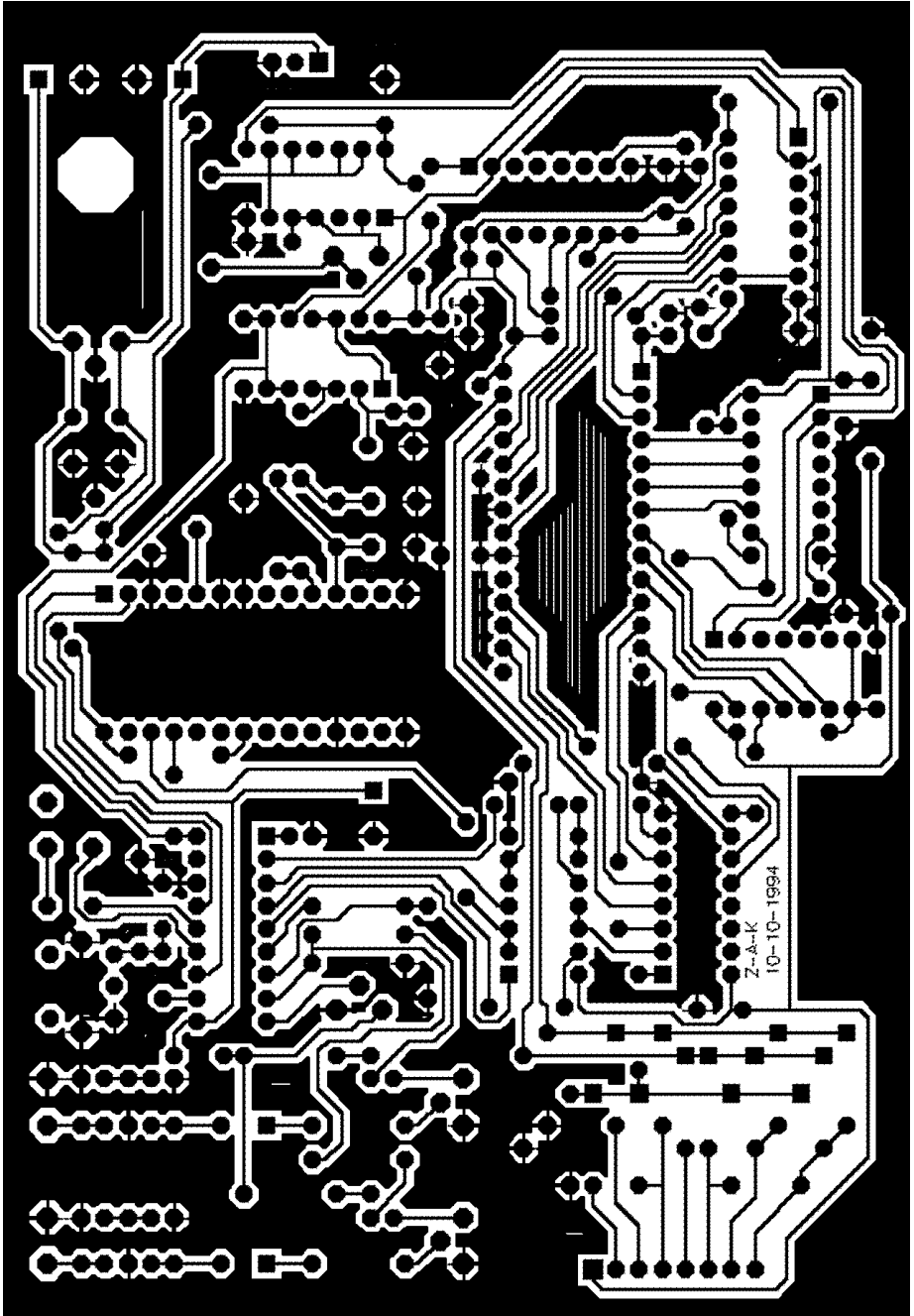

PCB pattern.

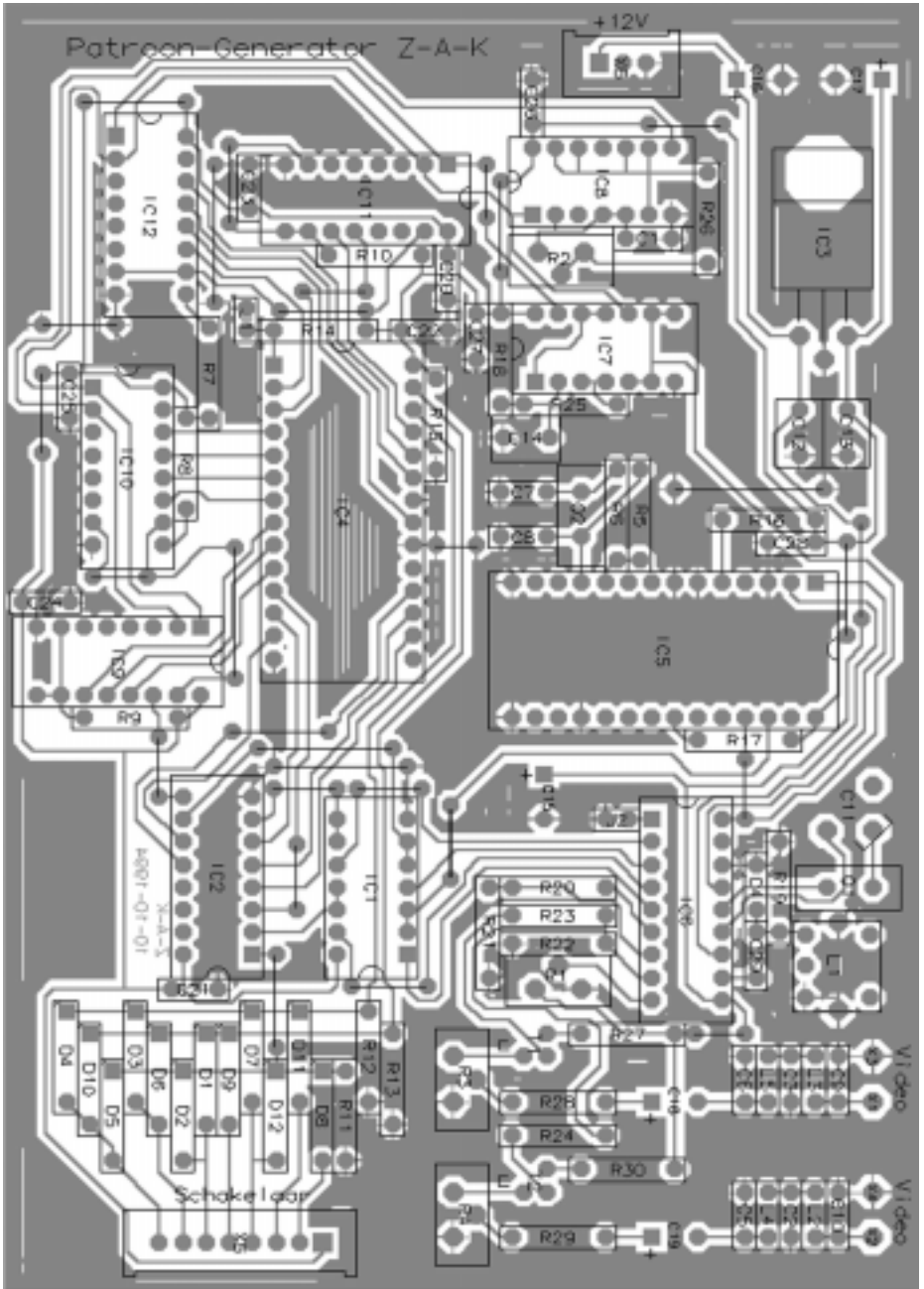

Component overlay

Tuning

There are few tuning points. With the aid of a frequency counter the oscillator in IC8 can be tuned to 4.9 MHz. Even without a frequency counter this oscillator can easily be tuned. Connect then the call sign generator to a television and tune IC8 until the vertical colour bars can be seen on the screen. The colour burst is the next item to be tuned. There are two tuning points at IC6 for this purpose. The oscillator frequency can be tuned to exactly 8.86 MHz with C11. The television screen will switch from black/white to colour. With L1 the colour burst can then be tuned to the correct amplitude with the aid of an oscilloscope. Together with C4, L1 forms a resonant circuit at 4.43 MHz. For L1 you can take a coil from any old video PCB or a Toko or Neosid coil set (10 x 10 mm) in which the 2 x 28 turns can be wound. The output voltage can be adjusted to 1 volt p-p with R3 and R4. The two low pass filters here have the function of suppressing any eventual "dirt" coming from the many TTL logic IC's. When the call sign generator is connected to a modulator that already has a good filter in place, this filtering can eventually be omitted.

Software

The EPROM can be programmed for 8 pictures. Each picture is built up of 128 x 72 pixels. The call sign generator repeats the upper 8 picture lines at the bottom of the screen so that 64 programmable picture lines remain. Joost van Reij has written a program in Pascal which can be used on any DOS compatible computer to fill in the pixels. As soon as the program starts the test picture (fig.5) to be programmed appears on the monitor. A grid can be placed over it and the filling of the pixels is a piece of cake. It is simply a question of clicking on the desired colour and with the aid of the mouse clicking the pixel into position. For filling a larger space it is possible to select an area and in one go fill it in with the desired colour. A text can also be typed in a selected area. There is a choice of different types and sizes of letter fonts. It is possible to program the eight test images one after the other by choosing the image from the image menu bar on the right hand side of the screen. When all eight test images have been completed to one's satisfaction the file can be stored. This file can later be burned into an EPROM with an EPROM programmer.

Starter Sets

Starter sets consisting of a print, an empty EPROM (27256) and software on a 1.44Mb floppy disc can be ordered by transferring 30 guilders to the giro account number 3360303 in the name of the Veron Treasurer, (afd.Eindhoven) in Nuenen under the reference "Patroongenerator" with the number desired. There is a limited stock of EPROM's so first come first served. Delivery is about four weeks. The estimated building cost of

Low Cost Programmable Video Callsign Generator

the callsign generator (including starter set) is around 100 guilders. For more information, and in case of emergency you can contact Kees Raaijmakers, PE I BEY via e—mail, PEI BEY at PI8ZAA.

This article first appeared in the Dutch magazine, 'Repeater' March 1997

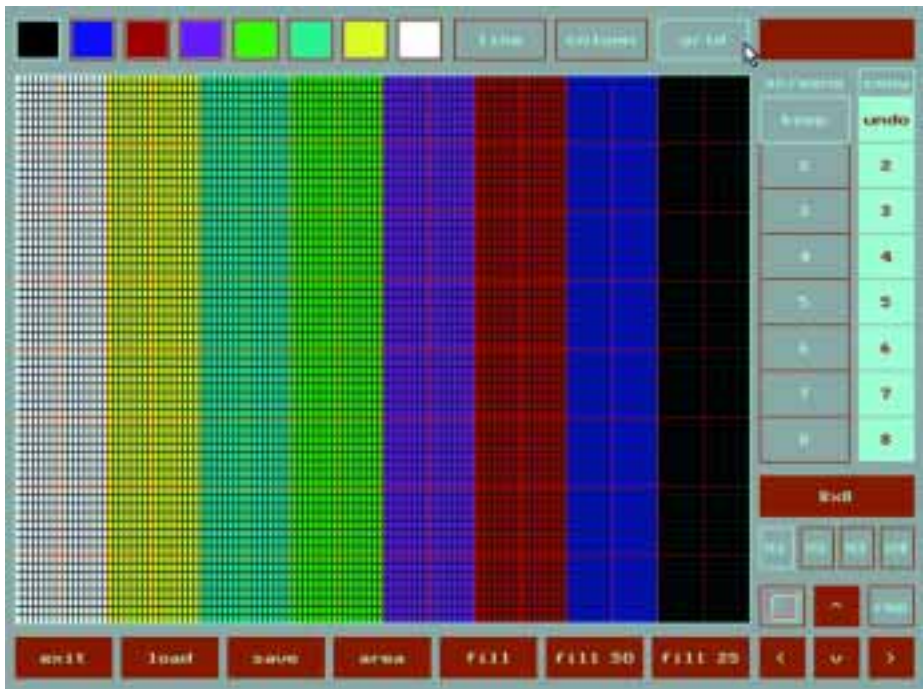

Output produced by the software

Note: Since this design originally appeared, a problem has been found with the limited colour burst that the callsign generator produced. It appears that the proposed low pass filters, for the two video outputs, falls off too quickly. Because frequencies in a chrominance spectrum well above 5MHz are not unusual, these are attenuated too much. To correct this, R11, R12 and R13 have each been increased to 10k and C2, C3 reduced to 1nF, and C5, C6, C9 and C10 reduced to 680pF.

(The TEA1002 can be obtained from Grandata, KP House, Unit 15, Popin Commercial Centre, Southway, Wembley, Middlesex, HA9 0HB, England. Telephone +44 (0) 181 900 2329. They will accept telephoned credit card orders— ED)

ATV at the Sandown Model Symposium May 9-10, 1998

By Dave McQue, G4NJU Hon Sec JRCUC

This event is one of the largest in the modelling calendar and occupies the whole of the Sandown complex with many outdoor displays. By 1 o'clock each day all off the on site car parks were full and late-comers had to be accommodated off site!



The organisers make provision for a limited number of Club stands. This year, due to commercial pressures, these were to be in the Foyer. In March I applied for a stand for The Joint Radio Control Users Committee (JRCUC), which is recognised by the RA as representing all radio modellers. (Modellers are the largest number of users of radio for hobby purposes in the UK). At the same time I asked if an ATV special event station could be accommodated to present Amateur Radio to a wider public. This was agreed. Having applied for, and got, GB0SMS I asked if the RSGB could get anyone to operate a voice station but there were no takers before the crunch date for passes etc arrived. It appears that there was a clash with the annual trip to Dayton to recruit members from the former colonies.

Friday was the setting up day and John Stockley, G8MNY, and Mike Sanders, G8LES of the Home Counties ATV Club came and put up their racks and antennas. Although the location of the Foyer is on the wrong side of the building, it was possible to access the Wycombe repeater, GB3HV, by arranging the antennas to see through two sets of windows!

The Foyer location meant that all the visitors had to pass the stand on their way to the various other exhibits. John and Mike had the same equipment stand at the VHF Convention at Sandown earlier in the year, but this time more amateurs spoke with them, signed in their book and collected UKRS leaflets.



The extent of public interest was also most gratifying. A surprising number of lapsed amateurs called in. They had taken up modelling in reaction to the de-skilling effect of amateur black box operating. Judging by the interest shown, some may well come back to take up ATV, which still requires a modicum of constructional skill.

In the States and on the continent, where licensed hams can use some parts of their bands for model control, many modellers become licensed and there is much synergy and use of amateur radio at events. In fact hams did much of the technological development of model control.

Until recently UK modellers could build transmitters from approved kits, but the new EMC regs limit TX construction to those for use on amateur bands by licensed amateurs. The power level requirement is such that the

70 MHz power limit of 10mW is more than adequate for surface use up to the range requirements of model yachts, cars and robots, as this rarely exceeds 50m.

Much other related electronics is still built and used by modellers and the installation of equipment often calls for much ingenuity.



Of course the ubiquitous micro now appears in many commercial rigs and home construction projects.

It is a pity that some of the influential members of the RSGB council should appear to take a negative view of the potential benefits of supporting a move for the skilled and responsible UK amateur having the same privileges as his American, French and German counterparts. Fortunately the youthful UKRS appears more open and supportive. Thus, I am now convinced, that it is the natural home for the forward thinking and technically active amateur so, of course, joined on the spot.

The successful appearance of ATV at this event has lead to a request from the organisers for a repeat at their International Model Engineer Exhibition, to be held at Olympia at the end of this year. In a previous year the BBC provided a video link from Ron Moulton's Blimp while it made stately excursions around the main exhibition hall. This time we shall be able to demonstrate how simple home constructed amateur TV equipment can be used to do the same.

Photographing the TV Screen

By John Stockley, G8MNY

Camera type

The best for this job must be a 35mm Manual (or semi manual), Through The Lens metering, Single Lens Reflex with a lens or vertical focal plane shutter action. With the SLR you can get in close to check the actual focus and avoid missing the shot due to parallax from a separate viewfinder. Autofocus cameras can get it wrong if they accidentally focus on the TV tube's glass surface and not the phosphor.

Don't use flash mode - although obvious, many small modern cameras insist on a flash rather than give a long exposure time.

Lining up the shot

Try to get close to the tube and aim to nearly fill the viewfinder, a wide angle or zoom lens can help with this, but do not get close enough to cause optical pin-cushion distortion from the bulbous tube. Keep the camera axis in line with the centre of the TV for best geometry and even focus.

If possible take the picture in a shady room so that black is black and watch out for reflections (e.g. yourself) etc. that never seem to be there when you take the picture! Set-up the TV to give a good sharp well colour balanced picture with the brilliance set so that the blacks are just visible.

If the shot is off a video recording then with a few practice plays you can select the best action, subject, steady shots, to snap. A VCR freeze frame will never look as good as a longer exposure snap with no motion!

The shutter

For shots of moving video, a 1/25 sec may be the best option if you camera can do this speed but there is a problem. With a lens or vertical focal plane shutter, horizontal brilliance bars may be visible as the shutter snaps approximately 2 TV fields, if the shutter timing happens to open and shut during TV flyback a perfect picture will be the result. So take several snaps of moving action and some will be OK. With a sideways focal plane shutter there will always be diagonal brilliance bars, so don't use fast shutter speeds or use the camera in portrait mode. If you need a fast action without bars try a VCR still frame with a long camera exposure time.

When there is no video motion, then slower shutter speeds give much better results - not only does the depth of focus greatly improve, but there

are so many frames averaged that any shutter timing brilliance bars are too faint to notice.

With noisy but well locked pictures there is a distinct advantage in using long exposure times, as much of the noise will be removed. Shutter speeds of 1/12, 1/8, 1/4 of a second or longer work well, but may require a tripod.

Gadgets

Using a tripod can help as you have more to view and set up the shot, you can use a very slow shutter speed without problems. Cable release can reduce the chance of disturbing the camera's aim even when on a tripod, this is especially true if using a telephoto lens or slow shutter speeds.

Exposure & Film

Use a normal daylight film, as TV sets are set up to give of lots of blue light that is seen by film as a daylight balance, even though your eyes do not. I recommend 200 ASA as being the most versatile.

If the exposure meter is not TTL or you cannot easily fill the viewfinder with the whole picture then take the meter/camera to the screen to take the light reading.

With low light subjects watch out for viewfinder backlight error readings that are possible with some TTL systems! Also with slow exposures the metering may give out or give silly readings. So take a reading at a more normal shutter speed then do a time/iris stop *f* calculation. e.g. Double the exposure time means reduce the aperture by 1 *f* stop position. All these are approximately the same exposure:-

Stop		Speed
<i>f</i> 1.4	@	1/100
<i>f</i> 2	@	1/50 (1/60)
<i>f</i> 2.8	@	1/25 (1/30)
<i>f</i> 4	@	1/12 (1/15)
<i>f</i> 5.6	@	1/8 (1/10)
<i>f</i> 8	@	1/4
<i>f</i> 11	@	1/2
<i>f</i> 16	@	1 sec
<i>f</i> 22	@	2 sec

Prints

If the pictures are taken in total darkness, the developer may not align the TV image in the centre of the print. If this often happens use some lighting behind the TV so that the camera frame stands out, or give printing instructions when you take the film in to be developed.

Photographing the TV Screen

For use in front of a TV camera prints should be gloss finish, as positioning the lighting etc can eliminate any surface glare. Prints with a matt finish give less highlight glare but always give a speckle grey instead of blacks when seen by a camera. (Daylight reflections can be reduced/virtually eliminated by the appropriate use of a Polaroid filter in front of the lens. – ED)

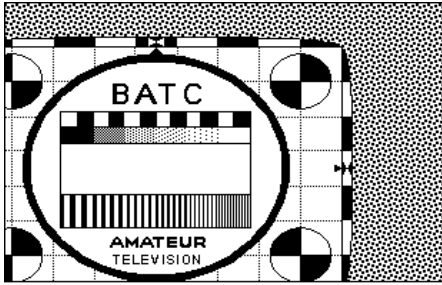

PARALLAX

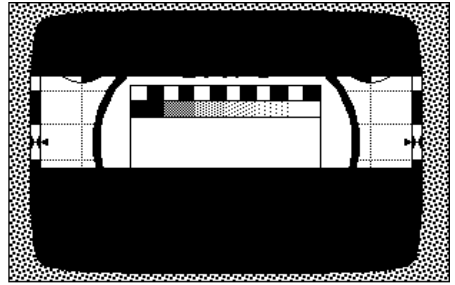

SHUTTER TOO FAST

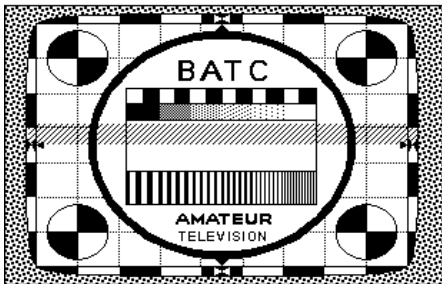

25th Sec SHUTTER

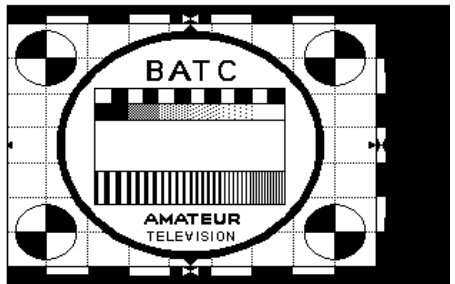

PRINTING ALIGNMENT

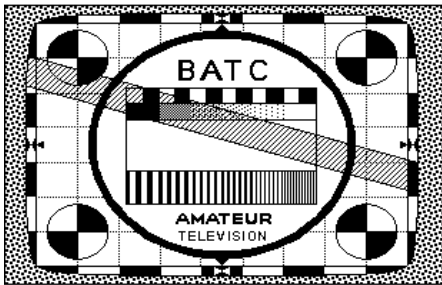

HORIZONTAL SHUTTER

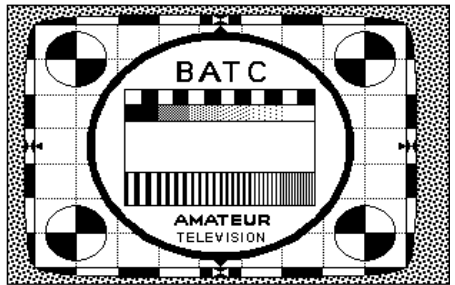

CORRECT

Various problems with off screen photographs

That was the Rally that was

By Mike Wooding G6IQM

The Rally was thankfully again a financial success, although with a reduced profit this year of around £700.00 - mind you this still represents a return of around 22% on the expenditure, so not too bad really! It was even more difficult this year persuading traders to come to the rally, in fact less than three weeks before the event I had only sold 50% of the trading tables. A few new faces were present and in the radio-related lines rather than computers and accessories. Apart from the difficulties, however, and with our esteemed Treasurer's attempts at coercion on the boot-fair traders, I managed to fill the hall again.



A view from the gallery

The Rally itself started for me around midday on the previous Saturday, when with my son Ashley I arrived on site complete with all the paraphernalia for the show and, of course, the VHF Comm. stuff as well. We battled valiantly until around 7pm when, with the help of the staff of

That was the Rally that was

TK Electronics and the total sum of ONE Club member, we had the hall laid out, the electrics sorted, and even my stand set up.



The Clubs stand manned by Peter Delaney (members services) and, with arms folded, Ian Pawson (yes, that's what your editor actually looks like!)

Sunday morning the alarm, somewhat rudely I thought at the time, went off at 6am and son Ashley and I were on the road to the hall at 6.30. The doors were open around 7 and the Rally took on a life of its own and was now unstoppable, and generally unalterable too. All the months of planning (?) were swept away as traders, stewards, helpers, boot sale people, etc., all did their own thing! - still the outcome looked OK. I must admit to being rather pleased that the Indian Wedding Celebration that was booked into the Cricket Hall had cancelled about two weeks previous - car parking would have been a nightmare!

Nine thirty arrived and the doors were opened!, officially only for the disabled, but I think Krystyna got carried away. After the initial rush there was a steady flow of visitors until around 1pm. Brisk business took place on the stalls and for much of the day the Club stand was also quite busy. Outside the 'enthusiasts' were doing whatever it is that they do with the OB and Link vehicles and the boot fair was doing brisk business - this year

An American's impressions of the 1998 BATC Rally

being very much under control under the watchful eye of Brian 'The Money' Summers.

By 5pm most of the visitors had left, the boot fair was nowhere to be seen and by 6 the hall was clear of traders and most of the tables cleared away. 6.30pm saw me back on my way home - it was all over again for another year, apart from balancing the books.

All-in-all Rally 98 was very successful. I would like to thank all the volunteers who helped over the weekend (!), without you it was almost an impossible task. I would also like to thank the Coventry Amateur Radio Society for providing and running the talk-in station and for their members' help during the day and also Coventry RAYNET for their assistance. Finally, I would like to thank you for supporting your Club and coming to the Rally. Perhaps next year you might remember that we/I need help on the Saturday as well?

Oh - one further thing. See you next year at Rally 99

The Sports Connexion, Leamington Road, Ryton-on-Dunsmore, Nr.Coventry: Sunday April 25th

Byeeee ... Mike

An American's impressions of the 1998 BATC Rally

By Jim Wood of Santa Cruz, California.

We had rain on the day of the rally. Upon arriving at the venue a bit after 9 a.m. unofficial car boot sales were already in progress, but clever use of polythene kept goods dry.

The "Sports Connexion" Hall was ideal for the Rally; a hundred or more trestle tables filled the space and were fairly groaning with old and new items for sale. The event was very well attended.

Now, I am not a "ham" and my own experience with exhibitions is limited to professional participation in big commercial conferences, but I was impressed with the BATC. The layout was orderly and well organised with foot traffic flowing freely past the stands.

I did notice a similarity between this show and the weekend "flea-markets" common in the U.S. in that there is an increasing participation in these informal events by professional commercial concerns. Rather than detracting from the spirit of the affair, however, as is sometimes the case in my country, the for-profit stands did complement the theme of the show, for the most part, with cables, antennas, software and tools which would be of use to television amateurs.

Deadline

Most stands broke down well ahead of the 5 p.m. show closing. This is strictly forbidden in formal exhibitions, but I think that all the business to be done had been concluded by 3 p.m.

BATC was a positive and pleasurable experience. I am carrying a couple of items back to the States myself!

Free Internet Dial-Up Accounts for BATC members

Caladan Communications, a UK based Internet Services Provider are pleased to be able to offer BATC members free dial-up access to internet e-mail and news services.

Contact Chris Smith (G1FEF) for more details:

E-mail: sales@caladan.co.uk Fax: 01933 777577

Web site: <http://www.caladan.co.uk/batc>

Or write to:

'Free BATC offer'
Caladan Communications
35 Pytchley Road,
Rushden,
Northants NN10 9XB

Deadline

Will all contributors please note that the deadline for articles for CQ-TV 184 is September 4th 1998. Please send your contributions in as soon as you can *prior* to this date.

If you would like to contribute an article for publication in CQ-TV, then please send it to the editor, either by post, or preferably by email. If you don't use a word processor, plain ASCII text is fine. Please see page 2 for address details.

The CQ-TV Word97 document template can be downloaded from our web site. Select the CQ-TV magazine link from the home page at <http://www.batc.org.uk>



BATC Publications

Publication	Each	Qty	Total
An Introduction To Amateur Television (225gm)	£5.00
The latest handbook full of detailed information on how to set up your ATV station, plus lots of new video and RF construction projects.			
Slow Scan Television Explained (275gm)	£5.00
The latest SSTV handbook detailing all the information you need to enter the fascinating world of Slow Scan Television: Basic principles, explanations of all the modes to date, commercial hardware and computer-based SSTV systems. Also various construction projects for SSTV equipment..			
The Amateur TV Compendium (155gm)	£3.50
The BATC handbook featuring construction articles on video units, 24cm and 3cm ATV, a Digital Frame Store, and much more.			
The Best of CQ-TV (150gm)	£3.50
A compilation of the best construction articles from CQ-TV's 133 to 146			
CQ-TV Back Issues:	£1.50
The following issues are still available. Please circle those required: 142, 143, 144, 147, 150, 153, 154, 156, 158 159, 160, 161, 162, 163, 164, 166, 167, 168, 169, 170, 171, 173, 174, 175,176, 177,178			
Special Offer: Any four of the above issues	£5.00
179, 180, 181, 182	£2.50
Index on a PC format disk (25gm)	£1.00
All main articles in past issues of CQ-TV and seven handbooks. Including page count, (essential for ordering re-prints) on a PC format HD floppy disk.			
CQ-TV Binders	£3.50
The BATC CD (IBM type PCs only)	£5.00
Total Goods and Postage - Amount Enclosed			£.....

Publications orders *ONLY* to: **BATC Publications, Fern House, Church Road, Harby, Notts., NG23 7ED, England.** Tel: 0152 270 3348 (Evenings/Weekends only please). E-mail: publications@batc.org.uk.

Name:		Mem No:	
Address:			

Items from these lists can **ONLY** be supplied to **CURRENT** members of the BATC. These lists supersede all previous ones.

The indicated prices for **Publications** include postage within the EEC. Will members outside the EEC please either try to estimate the extra postage required, or write for a quotation. All cheques **MUST** be drawn on a UK bank. (Eurocheques, in £ sterling, are acceptable). Items marked thus: ** are available only until present stocks are exhausted.

PLEASE MAKE CHEQUES PAYABLE TO ‘BATC’.

MEMBERS’ SERVICES. A description of the various PCB’s and components can be found in the ‘What’s What’ guide, or on the BATC Internet pages. URL <http://www.batc.org.uk> (A printed copy available on request, if you send a S.A.E.). Components for club projects are not available from Members Services unless contained within these lists. All club crystals are HC18/U (wire ended). To avoid delay and inconvenience, please be careful to include the correct payment with your order – please do **NOT** send stamps or cash. Post and packing costs are for despatch of one item to United Kingdom members.

Circuit Details can be found as follows:

Revised ATV Handbook (vol. 2): PCB’s 21, 22. **An Introduction to ATV:** PCB’s 10, 25, 36, 40, 41, 47, 85, 86. **TV for Amateurs:** PCB 19. **Slow Scan TV Explained:** PCB’s 59, 60, 61, 62. **Amateur TV Compendium:** PCB’s 12, 27, 54, 55, 56, 57. **CQ-TV (Issue No. in brackets):** PCB’s 7(174), 13(128), 16(134), 20(130), 26(142), 58(139). Item 46 is supplied with circuit details, etc

CAMERA TUBES A tube guide appears in CQ-TV 149 and 150. Tubes are now difficult to obtain and members requesting information on availability, prices or other types of tubes or equivalents are asked to send a stamped addressed envelope for their reply.

Members' Services

Qty	All prices in UK pounds (£)	Each	P&P	Total
Camera Tubes, Scan Coils, Bases & Lens Mounts				
3	One inch Vidicon base	1.20	0.30
4	2/3 inch Vidicon base	0.80	0.30
6	Camera tube (see page ii)	*	1.20
Video and I²C Circuit Boards/Components				
7	Sync pulse generator PCB	12.00	0.43
12	Teletext pattern PCB**	3.50	0.43
13	Greyscale/Colour bar generator PCB	3.50	0.43
16	PAL colour Coder PCB**	7.00	0.43
19	Video filter PCB	1.20	0.30
32	UVC3130-09 A-D and D-A IC**	47.00	0.30
20	Video processing amplifier**	4.70	0.43
21	Vision switcher matrix**	4.70	0.43
25	4 input TEA5114 vision select PCB	3.50	0.43
26	Video level indicator PCB	5.90	0.43
40	I ² C CPU PCB	10.00	0.43
41	I ² C VDU PCB	10.00	0.43
42	13.875 MHz crystal	4.70	0.30
70	6.0 MHz Teletext crystal	1.75	0.30
43	SAA5231 genlock IC	8.80	0.30
44	SAA5243PE Teletext IC	14.70	0.30
45	PCF8583 Clock IC	7.00	0.30
39	LM1881N Sync separator IC	3.50	0.30
81	I ² C 27256 EPROM	9.70	0.30
36	I ² C Video switch PCB	8.80	0.43
37	GX414 Video switch IC	8.80	0.30
38	PCF8574P Input expander IC	4.70	0.30
10	I ² C Relay PCB	6.50	0.43
9	PCF8574A Input expander IC	4.70	0.43

Members' Services

RX, TX and SSTV PCB's and General Components

47	70cm up converter PCB	13.50	0.43
50	108.875 MHz crystal	8.20	0.30
85	24cm ATV transmitter PCB	17.60	0.70
86	24cm solid state amplifier PCB	10.50	0.43
55	Gunn diode modulator PCB	3.00	0.43
56	10Ghz head unit PCB set	3.00	0.43
57	Tuneable IF PCB	3.00	0.43
58	6MHz audio subcarrier generator PCB	3.00	0.43
88	XR215 phase locked loop IC	5.00	0.30
60	G4ENA colour etc. SSTV mod PCB set	5.90	0.43
61	G4ENA SSTV transmit mod PCB	7.00	0.43
62	G4ENA auxiliary PCB	2.35	0.30
68	4.433618MHz crystal	3.25	0.30
69	5.0MHz crystal	3.25	0.30
46	4 Rail power supply PCB	3.50	0.43

Stationery & Station Accessories

73	BATC blue diamond clutchpin badge	1.75	0.30
74	BATC cloth badge	4.00	0.30
75	BATC equipment label (6)	0.25	0.30
76	BATC square windscreen sticker	0.10	0.30
78	BATC test card	0.50	0.43
79	BATC reporting chart	0.10	0.43

Total Goods and Postage - Amount Enclosed £.....

Members Services orders *ONLY* to: **Mr. P. Delaney, 6 East View Close, Wargrave, Berkshire, RG10 8BJ, England.** Tel: 0118 940 3121 (Evenings, Weekends only please).

Name:		Mem No:	
Address:			

Setting Vision Deviation

By Ian M. Waters, G3KKD

Setting vision deviation correctly is not easy, but it is important to get it right. This is especially necessary in view of the attention being given currently to specs., particularly for repeaters, and allegations being made that some are over deviated.

To my knowledge three methods have been published for setting deviation:

1. "The first Bessel null method" by Dave Allen G8LHD, in CQ-TV 157 page 26.
2. A method based on calibrating transmitter deviation, MHz/V. Then measuring the p-p modulating signal with pre-emphasis at the point of modulation and adjusting the deviation control to give the value required for ± 3.5 MHz peak deviation. By Bob Platts G8OZP in CQ-TV 181 page 80.
3. A method based on calibrating a receiver demodulator, V/MHz. Modulating the TX with a LF signal to give 0.7MHz deviation. Then due to pre-emphasis the peak deviation at 5MHz will be 14dB higher, i.e. ± 3.5 MHz. By John Stockley, G8MMY, also in CQ-TV 181 page 13.

When I received CQ-TV 181 I decided to try and compare the two new methods with method 1, that had been available for some time. I found that while methods 2 and 3 gave virtually the same answer, method 1 led to a considerably higher level of deviation.

A conversation with G8LHD revealed an error in that the effect of pre-emphasis had not been taken into account. This may explain some over deviation.

A revised procedure for the first Bessel null method, agreed with G8LHD, is as follows:

"Apply a 1.45MHz sinewave with an amplitude of 1.53V p-p to the modulation input of the transmitter. Turn the sound sub-carrier off. Observe the transmitter output on a spectrum analyser. Advance the deviation, from zero, until the carrier nulls out leaving only the modulation sidebands visible. The deviation will now be set correctly when a 1.0V p-p composite video signal is applied."

Setting Vision Deviation

The reason for the level of 1.53 V p-p is that the pre-emphasis increases the high frequencies by 3.7dB, or 1.53 times, between the test signal frequency of 1.45MHz and 5MHz.

Once this correction had been made all three methods gave virtually the same results. We may therefore safely assume that any of them can be used to set deviation correctly.

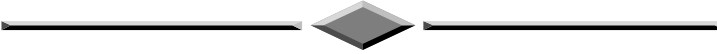

Visit our Web site at www.batc.org.uk
to view or download electronic versions
of recent issues of CQ-TV



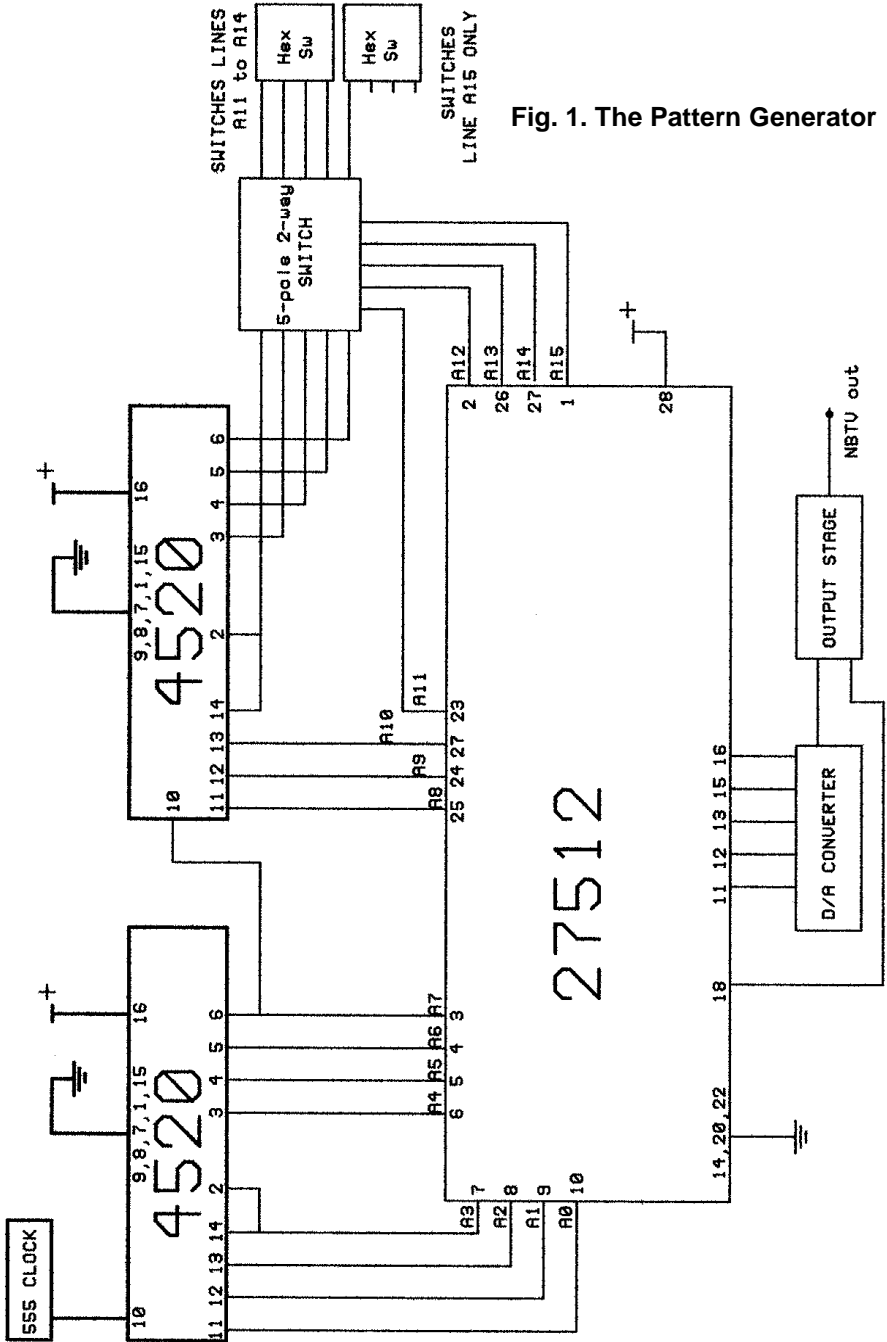

Fig. 1. The Pattern Generator

As the picture exactly fills the EPROM there is no need to have a special pulse to reset the counters, they are just allowed to free-run. A 5-pole 2-way switch is used to connect either the top 5 lines of the counter, or two Hexadecimal thumb wheel switches to the EPROM. (See Fig 1.) In one position the pictures are selected in sequence to give the film display and in the other position individual pictures can be selected for display by the Hex switches.

Another improvement over the Mk 1. Version is that 5 bits are allocated to the digital video signal thus giving a 32-step greyscale, which is much smoother in appearance and reduces contouring.

As we now need 16 address lines, two dual

hexadecimal counters (4520) are used. Another suggestion is to use two 4040 14-bit counters but this would require re-designing the layout.

The D/A converter + output stage (Fig 2.) was designed by Jim Wood, an NBTVA member who lives in California.

The clock oscillator (Fig 3.) should be set to $32 \times 64 \times 12.5 = 25,600\text{Hz}$; almost any oscillator will do for this job, but a circuit for a 555 is shown. If you haven't got a frequency counter, the correct frequency can be set by introducing a little AC mains hum into the video and this should show up as 4 stationary vertical "hum bars" on the screen.

For anyone interested in building up this circuit I can supply a PCB layout, but not the actual boards.

Graham Lewis has written an editing program in Qbasic which can be used to create a datafile for a picture. I already have a few sample pictures available and can offer EPROM programming facilities.

Needless to say, this unit goes well with the timebase and display unit that appeared in CQ-TV 182. The author can be contacted, via email, at nbtv@batc.org.uk

Fig. 3. Clock circuit

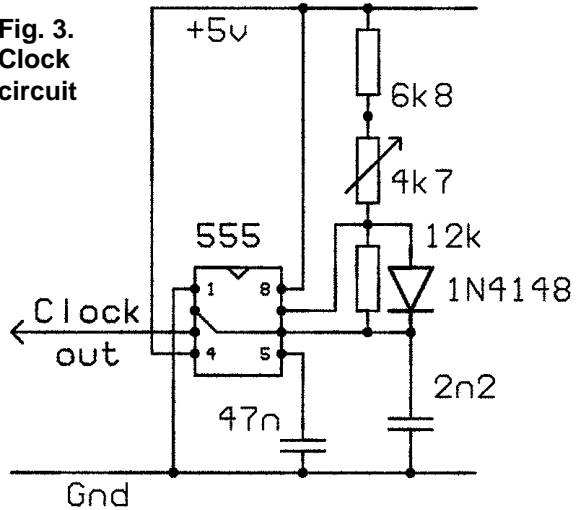

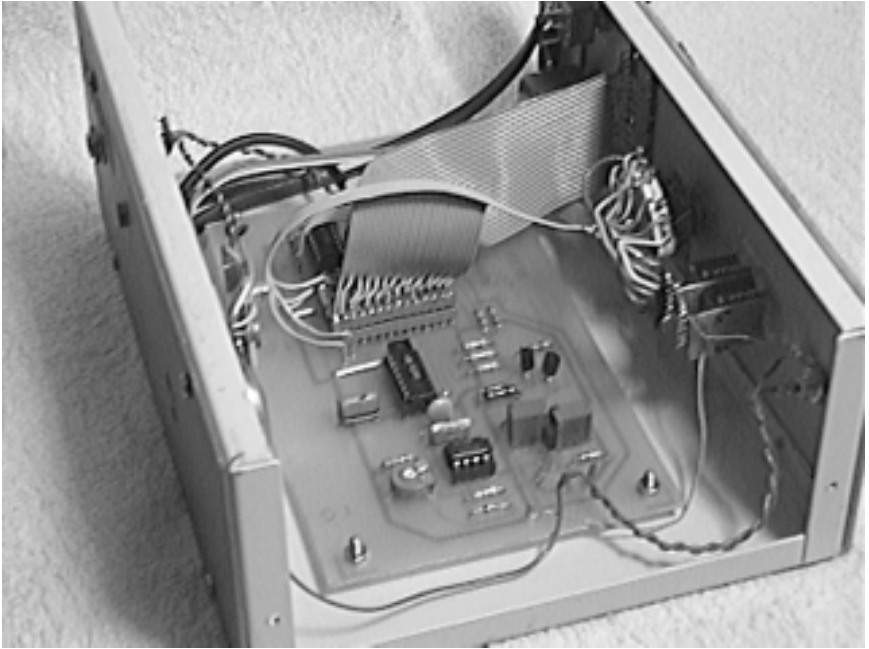

Pictures of the authors pattern generator



Sarnoff on Television

By David Sarnoff, Vice-President and General Manager, RCA

First published in Radio World Dec. 15 1928

More than thirty million people in the USA, through the electrical 'ear' developed by radio, are now regularly receiving a service of information, education and music broadcast through the air. We may hear, through sound-broadcasting, the drop of a pin across the continent. When will radio equip us with electrical 'eyes' that will permit us eventually to see across an ocean?

The horizon is as bright with promise for the radio 'onlooker' as it is for the radio listener. Within three to five years we may expect not only to see television broadcasting on an organised scale but even to receive distant scenes transmitted by radio in their natural colors.

Sums up Situation

Nevertheless the immediate situation is:

1. That television is still in the experimental stage;
2. That many refinements, improvements and even new engineering solutions are required in the transmission and reception of light images by radio;
3. That the broad highway in the ether necessary for the establishment of a television service requires continued research into the problem of locating suitable wavelengths.

The great problem of television is not the problem of making a magic box, through the peep-hole of which one may view diminutive reflections of passing men and events. The fundamental principles of sight transmission and reception are well understood. The greater problems of television are still bound up in the secrets of space.

Conversion Problem Great

Simply stated, the engineering problems involved in serving the eye, as radio now serves the ear, are the conversion of light waves into suitable electro-magnetic waves that can be propagated through space and converted back into light-waves at the receiving end. Recent demonstrations have shown how these problems have been met under experimental conditions.

But much further development is required. We are now working towards photo-electric cells of much greater sensitivity, for more brilliant and readily-controlled lighting devices, for better means of synchronising light elements on the scanning apparatus at each end of the radio circuit.

In the enthusiasm of invention, various steps in this direction may be announced as 'solutions' of the television problem. While we are forging the electric eye, as we have forged the electric ear, we have yet to build a road through space broad enough to accommodate the necessities of visual transmission.

Size of Sideband

We can use a wave side band of 5000 cycles for sound transmission, but we need a wave band of somewhere between 20,000 and 100,000 cycles or even more for visual broadcasting of continuing public interest. Nor is this the only problem which television faces.

The problem of radio television, is best visualised in considering the vast differences between the ear and the eye.

Electric and other modern means of covering distance have made the feet a secondary means of locomotion. The electric switch, the generator and the motor are coming very largely to take the place of the human hand. Radio and the wired telephone have extended enormously the range of human hearing.

But consider the eye, with all that science, discovery and engineering have accomplished in equipping man for the struggle of life, the eye still looks out naked upon the world, aided to a limited extent by pieces of curved polished glass.

Eye is Cranky Organ

A sensitive photographic apparatus, the eye demands that every scene be contracted to its limited field of vision. It tolerates but little interference. Shake a feather before the eye and you blot out the view of a mountain. Project two views simultaneously and you create confusion before the sight. Distort a picture and you destroy its recognisable elements.

Now, contrast this to the ear. The ear receives sounds from all directions. It is able to recognise and interpret the slightest tonal differences. By an act of concentration we can almost eliminate from consciousness the noise of a room full of people, and conduct a conversation with a single auditor.

Eye is different Indeed

Radio broadcasting found a pliable and sympathetic organ of reception in the ear. The ear will stand for a considerable amount of noise interference,

both natural and mechanical, with only a moderate loss of musical or tonal values.

Thus we have been able to overcome great obstacles to sound transmission by going over or around them. And so the sound of music may be heard over the roar of interference registered in the vacuum tubes.

But in attempting to serve the eye radio stands squarely before the fundamental problems of electro-magnetic wave propagation through space. Engineering solutions alone will not suffice to lift the bandage that has limited human vision.

A sudden blur of interference, hardly noticeable in sound broadcasting, may for an instance blot out a distant scene projected by visual transmission. Static, now overridden in the broadcasting of sound, may destroy entirely the broadcasting of sight.

“Within three to five years”

Within three to five years, however, I believe we shall be well launched into the dawning of sight by radio, involving the following developments:

1. Transmission of Still Pictures by Radio - with the progress already made in photographic or facsimile transmission, a new and universal form of telegraphic service is being developed, when messages, pictures, documents and other business forms will be transmitted photographically.
2. Radio Motion Pictures. - The transmission in rapid succession of a series of still pictures - otherwise, motion pictures - is a logical element in the development of sight transmission. Thus an educational or other event might be broadcast by a single radio operation to 100,000 or to 1,000,000 homes in the country; the same event, distributed through present-day methods, would require a million separate deliveries of a million films to a million homes.
3. Radio Television.- The instantaneous projection through space of light images produced directly from the object in the studio, or the scene brought to the broadcasting station through remote control, involves many further problems. Special types of distribution networks, new forms of stagecraft, and a development of studio equipment and technique are required. New problems would rain in upon the broadcasting station. New forms of artistry would have to be encouraged and developed. Variety, and variety would be the cry of the day. The ear may be content with the oft-repeated song; the eye would be impatient with the twice-repeated scene.

4. Television in Natural Colors. - The problem of transmitting electrical currents, translatable into light waves that will reflect objects and scenes in their natural colors, is a further development which may be reasonably expected, once the fundamental problems of radio television have been solved. When that time comes, as I believe it will, and when three-dimensional projection is added to the art, it will be difficult to differentiate between reality and its electrical counterpart.

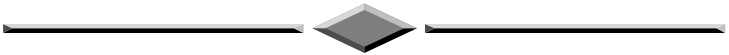

**A must for all
PC owners.
Hundreds of
back Projects,
many not
available in
any other
Format.**

Send orders
to the BATC
Publications
department.

Early Photicon Camera

By Ian M. Waters, G3KKD

Paul Marshall, in his article in CQ-TV 181, on the Photicon camera at the IBC, made honourable mention to the amateur camera using one of these tubes that I made years ago. I thought you might like some pictures of it that were taken in 1952.



This picture shows the BATC founder, the late Mike Barlow, G3CVO with the microphone, while I am operating the camera.

I am sorry that the picture of the camera with covers removed, shown on the right, is poor, but it is the only one I have showing the layout of the tube etc.



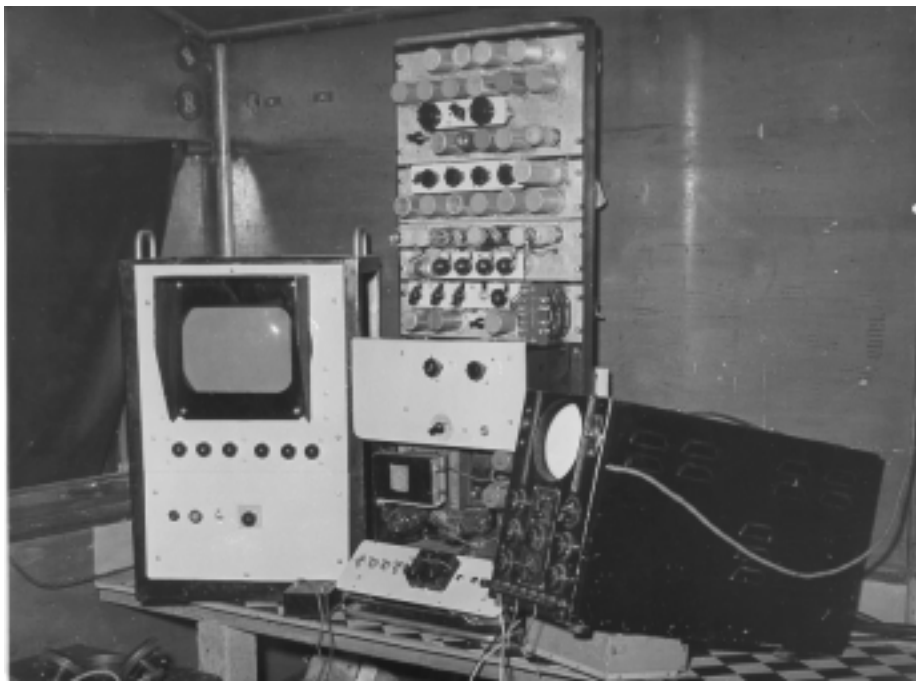

This picture shows the camera control unit (CCU) rack with picture and waveform monitors.

The CCU was made mainly out of war surplus parts from Lisle Street etc. The monitor was home made, all monitors had to be made in those days. The WFM is a wartime Cossor scope. Mention of war surplus reminds me of the caption used by the News Chronicle when it did a story on ATV.

“Tin can television hums into life thanks to Adolf”. The popular media never changes!

Jeremy Royle G3NOX (he is standing behind Mike Barlow in the above picture) also made a Photicon camera.

**Please mention that you saw it
in CQ-TV when responding to
advertisers.**

Worthing & District Video Repeater Group

GB3VR & GB7VRB

1Watt FM-TV 24cms Transmitter

The 1 watt transmitter generates its signal at the wanted frequency which can be set anywhere in the band, colour or B/W. On board intercarrier sound and fixed pre-emphasis are standard features. The kit includes the PCB all the on board components, pre-drilled heat sink, an Eddystone Di-cast box and full and comprehensive instructions. Building time is three evenings work. The new price for this kit is £80.00, P&P £2.50. Over 650 units sold to the Amateur market alone.

This is probably the biggest selling TX kit in the world!!!

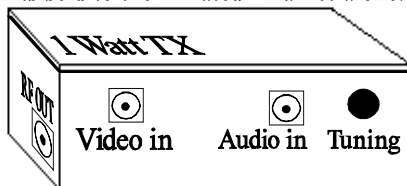

Two channel phased locked loop kit.

This add-on kit vastly improves the overall stability of the 1 watt transmitter. Two crystal locked channels and a third free running tuning position are available. Kit price £30.00

Amiga ATV Program-2

The New Amiga ATV program has more features than ever, up to 56 testcards, 20 wipes, superb text control, 30 screens of text messages, QRA calc, Testcard music, selectable displays, and this version has a DTMF tone pad to control your repeater. All testcards are over-scan i.e. the whole screen is used, Load in your own customised testcards, Extra large text, scrolling text, clock, callsign extensions, Hot key operation, Doc reader, ATV Cli, Cross Hatches, Purity and a comprehensive section for genlock users. For any Amiga with 1meg or more, state callsign and QRA (if known) when ordering, this three disk set is now only £10.00 P&P 75p

Spectrum ATV Program

Still selling after all these years, why, its good, its cheap and it works on all spectrum based machines. The 48k version has over 60 commands which include 7 Testcards, Memo pad, clock, maps, tones, QRA locator, various size printing, plus disk transfer routines and much more. Now only £5.00 P&P 75p

PC ATV is coming.

Orders should be sent to:-

Treasurer of GB3VR, R. Stephens, 21 St. James Ave., Lancing, Sussex, BN15 0NN. Cheques payable to "W&DVRG" Tel (01903) 765760 7 to 8pm.

By Graham Hankins G8EMX.

New 10GHz ATV repeater GB3DJ is located at St. Georges, about 1km north of Telford and became operational on May 7. Members of the Shropshire ATV Repeater Group, with Dave Hall G8VZT as Group Secretary and holder of the Notice of Variation (NoV) built this repeater.

Dave says: "GB3DJ is entirely home-brew, even down to the PCBs. The 3cm transmitter achieves around 100mW at 10.135GHz and the repeater has been seen at Stoke on Trent and even as far north as Manchester. 'DJ receives at 10.425GHz and has around 12 regular users."

While the Telford repeater was being switched on in May, another new 10GHz ATV repeater was being granted approval. "GB3BG will be at Sedgley, in the West Midlands", says Alan Kendall, who is chairman of the Beacons Repeater Group. Alan continues: "I will shortly be applying for an NoV to my licence, and expect the repeater to be in service by mid-summer. GB3BG will use an input of 10.425GHz, transmitting on 10.135GHz".

Meanwhile, the Beacons Repeater Group is slowly progressing its 1.3GHz project to the north of Birmingham. At the site, the BRG needs to achieve either a safe access to the top of an existing high structure, or provide a new means of mounting the dual-slot antenna. So, a scaffold tower system has been erected, which should at least provide a working platform and stable mounting for a length of mast and the dual Alford-Slot antenna during test transmissions.

More permanently, three sections of triangular mast structure are also available - these can be supported from within the scaffold before tethering to the ground. Quite a mechanical and transportation task ahead, because the sections are each 3 metres long, quite heavy and need taking to the site.

"It seems odd that there is, as yet, no 1.3GHz Amateur TV Repeater operating in the London area". This is the opening statement of a letter by Roger Glover G8IUC and John Douglas G4DVG who, with a number of other keen ATV operators, have formed the North London Television Group to remedy this situation.

Creation of the North London TV Group (NLTG), with Roger as chairman and John as secretary, is the latest move of a number of schemes for an ATV repeater that have been put forward over a period of time. Most recent of these has been the preliminary work by the Cheshunt and District

Amateur Radio Club - indeed, members of the Cheshunt ARC built a lot of the repeater hardware. But a licence application was never submitted, so no substantial further progress was made. The NLTG aims to build on what already exists and progress the essential administrative details.

Proposed site for the north London ATV repeater is atop the Enfield Civic Centre. Using back-to-back bow-tie antennas, line-of-sight path predictions indicate that these will provide a good service to inner, north and south London, with topography and radiation pattern preventing interference to neighbouring ATV repeaters GB3TV (Dunstable) to the north west, GB3HV (High Wycombe) to the west and GB3KT (Kent) towards the south east. By the way, the Kent TV Group ARE affiliated to the BATC; my apologies if what was intended as a general reminder to all Groups of affiliation a couple of issues ago may have inferred otherwise. I picked up a KTG newsletter at the BATC Rally, but this - again - is a reminder to ALL Groups - please put me on your newsletter mailing list.

All ATV Repeater Groups - need ongoing support from the local amateur community. The initial work, and in many cases finance to put a repeater on air may very well have been provided by just a few people, who were prepared to make this commitment in order that the project would be completed. But ATV repeaters 'grow' as facilities are added, 'grow old' so need replacements and there are the running costs of insurance and, usually, electricity. Don't leave all this to 'the few'; repeaters are provided for the 'many'.

After all the reports this month of new and planned f.m. repeaters on 10GHz and 1.3GHz, it's easy to forget that a.m. ATV on the 430-440MHz band continues to be available. Ok, so there are some limitations - no inter-carrier sound, and a relatively narrow band with many other users (so ATV operators are encouraged not to transmit colour and to limit their monochrome bandwidth).

New Zealand certainly has an active 70cm ATV scene, as my overseas correspondent Michael Sheffield ZL1ABS reports: "The monthly 70cm ATV Net on the 70cm National System was held on May 27. This ran from before 8pm until after 9pm, with a Conference award net in the middle. The 70cm net controller was Grant ZL1WTT, handicapped a bit by an 'iffy' 70cm rig".

Sending reports to TVOA

My E-mail address continues to be graham@ghank.demon.co.uk but I would really like to receive a lot more newsletters via 'snail mail'. Don't forget, it's not just 1.3GHz; let's here some news of 70cm ATV contacts, 10GHz, any other ATV band AND Slow - Scan ! 73 and P5 for now, de Graham Hankins G8EMX, 11 Cottesbrook Road, Acocks Green, Birmingham, B27 6LE.

VHF COMMUNICATIONS

VHF COMMUNICATIONS magazine is published quarterly and is available from **KM Publications**, 5 Ware Orchard, Barby, Nr. Rugby, CV23 8UF, England.

Telephone: 44 (0) 1788 890365, Fax: 44 (0) 1788 891883

Email: vhfsubs@vhfcomm.co.uk



The 1997 subscription rate is £18.00 for cash or personal cheque (drawn on a UK bank, or bearing the name of a UK banking agent), postal orders or bankers draft made payable to VHF Communications. Payment may also be made by any major credit card at £18.90. The subscription included surface mail charges, airmail is extra at £6.50 per year (£6.85 by credit card). The magazine is a MUST for the radio amateur and professional engineer interested in VHF, UHF and Microwave working, containing, as it does, detailed construction articles for equipment operating in these bands.

Back Issues: special offers - enquire for details

Binders to hold 12 issues £5.50

Complete Index 1970 - 1995..... £2.75

Email: vhfsubs@vhfcomm.co.uk Web site: <http://www.vhfcomm.co.uk>

Secure credit card page: <https://www.vhfcomm.co.uk/saleform.htm>

Auto Etch, an automatic etching bath

By Eric Edwards GW8LJJ

I needed an automatic means of etching printed circuit boards. I usually adopt the free-hand method of rocking the tray. This, I found, took a long time. I tried vigorously shaking the tray whilst wearing protective clothing as the acid would splash the more vigorously I shook the tray. This method, although speeding up the etching time, is not recommended due to the dangers involved, unless you want to walk around with etched - on freckles! Looking through the usual electronic supplier's catalogues for some means of automating the process I could only find expensive tanks that needed a pump and other add-ons. I needed something that could safely vibrate the tray of acid and leave me to carry on with something else. The method I chose was a vibrating table.

Table Construction

The basic material for this is a five foot length of curtain rail. The plastic type that has two runner grooves. One that would normally be used to secure the rail to the window frame and the lower groove that holds the curtain hooks. This is cut into four lengths that will be assembled into a rectangular picture frame. Two 19 inch and two 10 inch were the lengths I used. This was governed by the size of the trays used for developing and etching. I use 11 x 9 inch approximate size trays. After cutting to the required lengths, small angle brackets made from aluminium, two inches long and bent at right angles will be slotted into the grooves of each piece of rail to enable them to be assembled at right angles with holes drilled in the angle brackets and the rails to take small (2.5mm) nuts and bolts to secure the whole frame. Before fitting the last shorter piece of rail, a base plate and sliding platform is to be slotted into the frame. The lower sheet of aluminium or plywood or (whatever material is available), is secured in the frame by small screws. This base plate is to house the solenoid. This piece of equipment was removed from a scrap (well, it is now!) U-MATIC Video. It comes complete with it's own lever which is a length of stiff wire with a small hook on one end to enable it to be fitted to the solenoid plunger and the other end has been bent to the shape of an eyelet that is used to fasten to the top moving platform. A coiled spring is fastened to the back of the top moving plate by drilling a small hole, and placing the other end of the spring in the bottom fixed plate also by drilling a small hole. Select and adjust the spring until there is sufficient, but not too much, tension to allow the solenoid action. An end of travel screw should be fitted into the rail to stop overshoot of the moving plate.

Auto Etch, an automatic etching bath

Test this set up by applying about 30 volts DC (available after rectifying 20V secondary of the transformer). Momentarily apply this voltage and check that the solenoid plunger is working unobstructed and there is sufficient travel of the top plate. (You will need a good transformer of around 20 VA depending on the current drawn by the solenoid). Depending on the solenoid you use, the transformer secondary may differ to the one in this diagram. If the solenoid is weak in operation, providing the spring is not the cause, then the transformer secondary is too low as you may be using a higher voltage solenoid. If, however, the solenoid flies back in as if on a very large elastic band then the transformer secondary is too big, probably because you have a 12 volt solenoid.

There are two secondaries on this transformer, one for the solenoid and the other for the 12volt regulator. The reason for choosing two secondaries is to isolate the NE555 circuit from the solenoid circuit to reduce the risk of damaging the timer circuit, due to voltage peaks whilst the solenoid is intermittently energised damaging the regulator. Fitting a diode or capacitor across the solenoid either stops it working altogether or subdues it's operation which defeats the object as it needs a good action for the table to be effective. If all is well, place your etching tray with sufficient water to cover the copper board for etching. Water will not etch your board but if water splashes out it will not create any personal harm. When you are completely satisfied that the unit is working in its basic form then you can concentrate on the electronics.

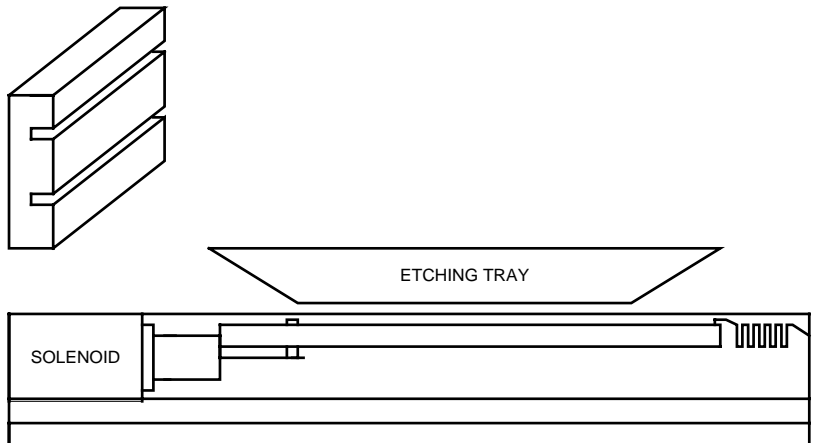

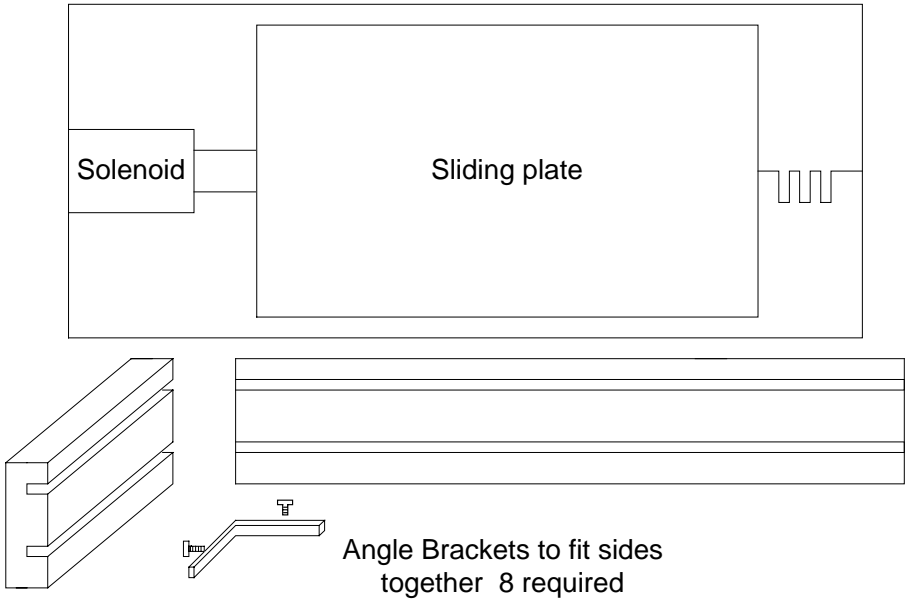

The Electronics

The heart of the electronics is a NE555 timer operated as a free running astable. The rate of vibration is controlled by a potentiometer connected in series with a 2k2 resistor to give a good variation of frequency. It can be set so that a slow back and forth movement is used for developing the photo sensitive copper board and then set for a faster speed for etching with hot ferric chloride. The speed can be set for almost ultrasonic speed.

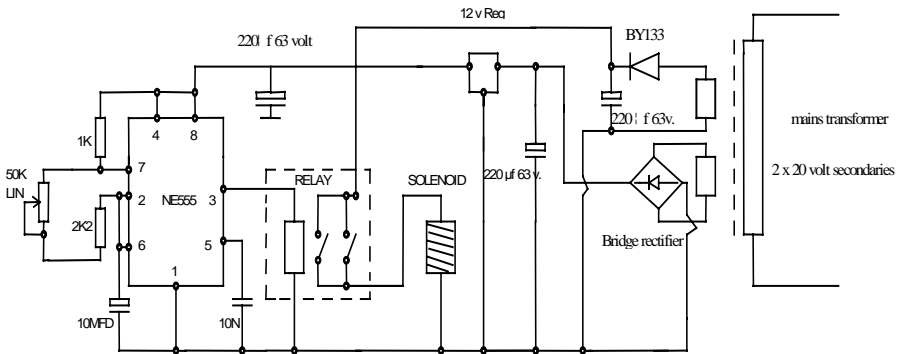

Circuit diagram

Auto Etch, an automatic etching bath

There are other uses of this unit, for example automatic developing of photographs and if the speed was further increased by selecting different values of the variable resistor or capacitor from pin 6 to ground then it could be used as an ultrasonic bath wash.

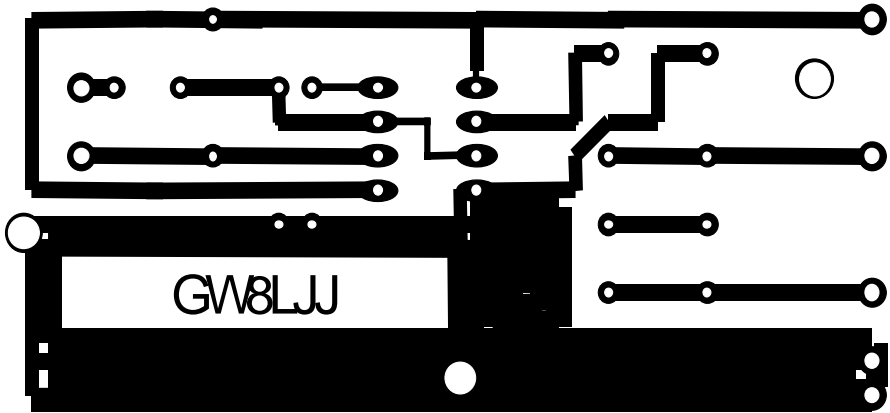

PCB layout. The tracks are viewed looking “through the board”

The output of the astable at pin 3 is taken to a relay. Yes that’s right, a relay. I already had a few of these in the junk box. The type used was a RS Components type part number 346-851. This has a 6 volt 66 ohm coil that is suitable for this design. The two sets of contacts are wired in parallel to maintain good switching contacts. Do not use a diode across the solenoid.

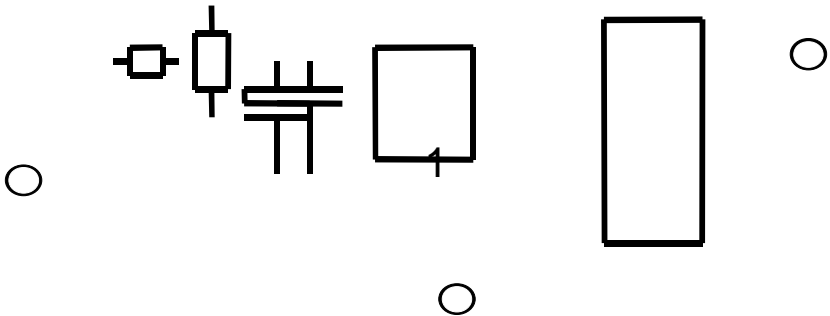

The Component layout on top of the board

Auto Etch, an automatic etching bath

The solenoid supply via the relay is taken from the half wave rectifier to give about 30 volts. The solenoid itself has a 24volt coil but higher voltage is used to ensure good action. This voltage is OK as it is pulsed to the solenoid. A 12 volt regulator circuit with its supply taken from the bridge rectifier of the other secondary winding is used to supply the NE555, which will give a switching supply to the relay of about 6 volts.

A printed circuit board can be produced for the electronics, but you will have to etch free hand or it can be built on stripboard.

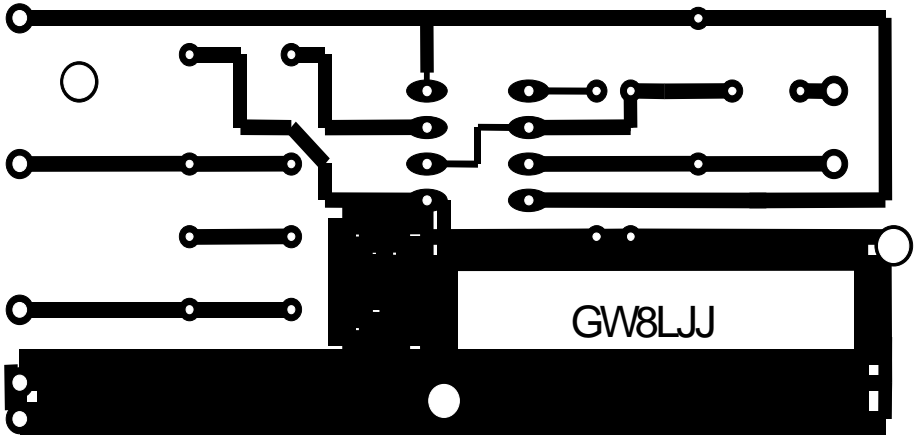

The layout inverted

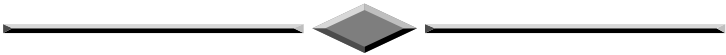

N1500 and N1700 tapes converted to VHS or UMATIC free of charge (I can also convert them to 405 line in the process if you require). Please send a blank VHS or UMATIC tape, your original N1500 / N1700 tape and a stamped addressed Jiffy bag to **Mike Bennett G7TRF, 3 High View Gardens, Exmouth, Devon. EX8 2JR. Phone: 01395 279732 or E-Mail mdb2@permanent.co.uk 3 High View Gardens, Exmouth, Devon, EX8 2JR Phone 01392 449291 (Daytime)**

Sevenside Television Group

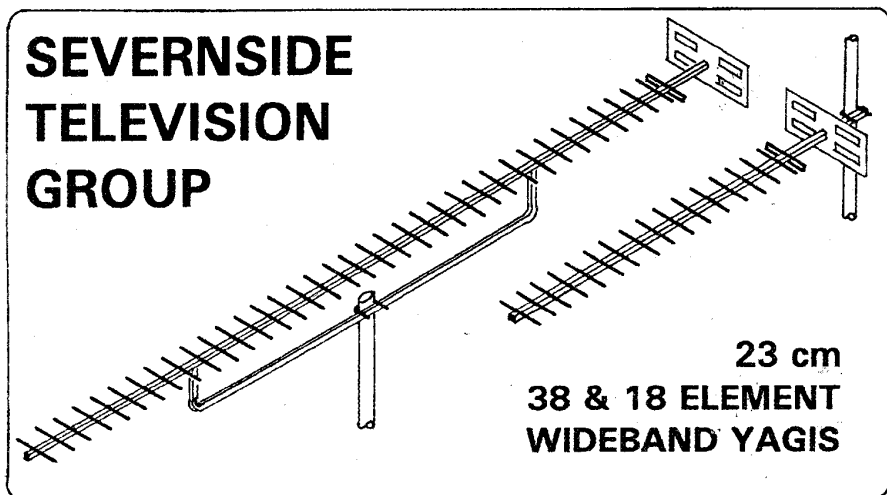

All of our 23 cm Aerials are specifically designed for ATV use - although they can be used for other modes as well. Wideband characteristics mean that you need only one aerial to cover the repeater input and output channels. Our famous wideband yagis come fully assembled in two versions:

38 ELEMENT HIGH GAIN: 14 dB gain, 1.8 m long, **£26.00** plus postage.

18 ELEMENT STANDARD: 10 dB gain, 0.9 m long, **£15.00** plus postage

Don't forget our **20 ELEMENT CONVERSION KIT**, which converts your existing 18-element aerial to the full **38-element** high gain specification: **£13.00** plus postage. Our 23cm **TROUGH REFLECTOR** is quite unique, combining 11dB gain with wide bandwidth *and* wide beamwidth. It's also compact, just 0.55 m high, 0.35 m wide and 0.3 m deep. Supplied as a kit of predrilled and preformed parts for easy "Screwdriver" assembly: **£19.00** plus postage. All aerials feature an SWR of less than 1.5:1 and are supplied with mast clamps suitable for masts up to 55mm diameter. Mast poles shown are not supplied.

POSTAGE: **£3.75** for one aerial, **£5.00** for two or more. Telephone orders with cash on delivery: **£2.75** supplement per order, Orders from outside of the UK - please write for carriage quotation.

CHEQUES payable to "SEVERNSIDE TELEVISION GROUP" and send to 18, Linnet Close, Patchway, Bristol BS12 5RN. Telephone (evenings and weekends only please) 0117 969 8136. Please allow 28 days for delivery.

Memories of Alexandra Palace

By Ian M Waters G3KKD

I found the contribution in CQ-TV 182 by Dicky Howett “A very colourful time” most interesting. It brought back a flood of memories.

In 1956 members of the BATC were invited to Alexandra Palace to view the colour studio in operation. Having then only been used to seeing a field sequential colour, we found compatible NTSC very interesting and impressive. I cannot now remember all who went, but apart from myself Ivan Howard G2DUS was present and very probably Grant Dixon.

This prompted an attempt to receive the colour transmissions on Band 1. A 14 inch black and white receiver was converted using some information from an American magazine. A burst locked colour sub-carrier oscillator was added. This fed a phase shifting line. A ring counter, locked to the field sync, provided three outputs which were used to gate signals from this line with phases appropriate for the demodulation of R, G and B. The demodulated chroma was then multiplexed with the luminance and fed back to the tube. Colour was provided by a 3-foot diameter colour disk with R, G and B filters, driven by a 1/8-hp motor.

The disc was provided with real flywheel syncs! Pulses from a coil excited by a magnet on the disc shaft were compared in a phase comparator with the output of the ring counter. The output of this was amplified and used to control a saturable reactor feeding the motor field. A rheostat controlled the motor speed until the colours locked in the correct sequence.

The whole contraption was never very effective, mainly because the AP signal was fringe at the best of times in Ely and worse when the transmitter power was reduced to improve modulation linearity in the interests of differential gain and phase, which have always been a problem with NTSC. However we did see colour pictures. The receiver was a bit lethal with the disk running at 750 rpm totally unprotected in a blacked out shack!

This may revive memories for other older members and perhaps surprise some younger members to hear of the things we got up to in those days.

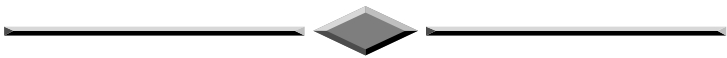

By Paul Holland G3TZO

Due to editorial pressures this really is a short edition of Satellite TV News this time so lets get on with the news.

Cable & Satellite 98

This year's Cable & Satellite Show at Earls Court provided an opportunity for both broadcasters, satellite operators and manufacturers to showcase the latest developments in digital television technology. Although there were still many new analogue receivers on show, the emphasis was heavily on digital. Probably the most interesting equipment for UK residents was the first glimpse of Sky's new "Digibox" digital satellite receiver, together with pre-production examples of new elliptically shaped antennas for the 28.0 Deg digital slot.

On display were Pace & Grundig "Digibox" receivers. The Pace receiver has 2 card slots, one for the digital smartcard (NDC Videoguard) and one for a Mondex smart bank-card (for PPV events & subsequently interactive shopping). Key design features revealed include;

- Sky Electronic Programme guide

- Macrovision 7.01 video encoder for all composite & RGB output signals

- Symbol rates of 20-30 Megasymbols/second.

- Widescreen aspect ratio support (switchable 4:3/16:9)

- RS-232 interface

- V32 (withV42bis) modem

- 2 scart sockets.

- IEEE 1394 (firewire) to allow connection to DVD players.

- RF input/outputs

- 4MBytes each of flash RAM & SDram.

Subscription charges are said to be "broadly in line with analogue".

Cambridge revealed their AE100-DP integrated elliptical dish and integrated elliptical feedhorn. The design is optimised to minimise antenna size (520x390mm) while maintaining high efficiency and reducing adjacent satellite interference. The skew setting can be adjusted between +/- 0, 4 and 8 degrees. The antenna covers 10.7 - 12.75 GHz with the integrated universal LNB having a noise figure of 0.9dB.

Launch News

The main launches for the rest of this year are summarised below. Dates as usual will change depending on the success or failure of previous launches. At the time of writing the Eutelsat W1 launch had been put back to August or later due to a fire during antenna tests at Aerospatiale's Cannes factory.

Satellite	Date	Position	Launcher
Thor 3	1998 June	0.8 W	Delta 2
Intelsat 805	1998 June	55.5 W	Atlas AC13
Eutelsat W1	1998 August	10.0 E	Ariane
Sirius 3	1998 August	5.0 E	Ariane
Astra 2A	1998 August	28.0 E	Proton
Eutelsat W2	1998 September	16.0 E	Ariane
Hot Bird 5	1998 October	13.0 E	Atlas
Astra 1H	1998 November	19.2 E	Proton
Eutelsat SESAT	1998 December	36.0 E	Proton

Thor 3

Norway's Thor 3, which was scheduled to launch in June, will cover 18 European countries with a footprint covering Scandinavia and Central/Eastern & Southern Europe. The footprint is shown below.



Among the first broadcasters moving onto Thor 3 will be British Sky Broadcasting, and Sweden's Viasat (Kinnevik) both of which will broadcast in analogue. Telenor already has contracts and potential customers, and expects to fill 50 percent of Thor 3's capacity by the end of this year. Broadcasters on TV-Sat, also at 1 degree West, will also be moving to Thor 3. There will also be new digital services for the Nordic market, such as home shopping, video-on-demand, and fast Internet access.

Thor 3 will carry the following transponders:

11.727, 11.747, 11.823, 12.054, 12.149, 12.169, 12.226, 12.245, 12.303, 12.322, 12.380, 12.399, 12.456, and 12.475 GHz.

The launch of Thor 3 will see a number of channel moves including;

Sky News & Documentaries will move in analogue format from 11.773 R on Thor 1 to 11.727 V on Thor 3.

TV3+ Denmark will move in analogue format from 11.977 L on TV-Sat 2 to 11.747 H on Thor 3.

TV1000 Cinema will move in analogue format from 11.888 L on TV-Sat 2 to 11.823 H on Thor 3.

Sky Entertainment will move in analogue format from 11.667 V on Intel 707 to 12.054 H on Thor 3.

Sky Entertainment will also start in digital format on 12.226 V on Thor 3

TV Butikken will start in digital format on 12.322 H on Thor 3.

In addition, DR 2 will move from its spot on 11.667 V on Intel 707 to MTV Europe's current transponder on Thor 2, 11.434 V. TV-Sat 2 will probably be made redundant by late autumn. Thor 1 is scheduled to stay in orbit for some time.

Other Launches

SES are planning to lift Astra 2A into orbit about the time you read this to relieve Astra 1D of its temporary duty. June 12/13 saw the launch of Intelsat 805 which replaced Intelsat 505 and 510 at 33°E.

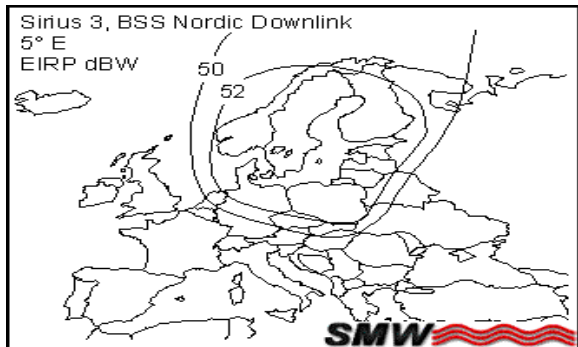

Other launches around now include Sirius 3 in August (see footprint on previous page), Eutelsat W2 in September and Hotbird 5 in October.

NILESAT

Here is the initial line-up for Nilesat which was launched in May. All transponders carried clear or Irdeto-encoded MPEG-2, SR 27500, FEC 3/4 at the time of writing with reception being reported in many southern UK locations.

- 11.747 Tests
- 11.766 ERTU 1/2, ESC 2, Nile TV International
- 11.823 Imhotep Channel, Horus Vision, Oman TV, Bahrain TV
- 11.843 1st Net package
- 11.900 1st Net package
- 11.919 ERTU 8, Nile Drama Channel
- 11.996 Showtime package
- 12.034 Showtime package

Channels coming and going

Sweden's TV3 has moved from Sirius 1 to Sirius 2, remaining on 12.092 GHz, in Eurocrypt-M encoded D2-MAC.

Denmark's Star TV has started at 1 degree West on Thor 2 in clear D2-MAC on 11.389 GHz, and on Intelsat 707 in clear MPEG-2 on 11.592 GHz.

Channel Bizarre was supposed to launch in June. The channel is licensed in the Netherlands and will use EUTELSAT II-F3, 16 E using D2 Mac Eurocrypt.

What's happening at 28.8 Deg E !

While we await to see if Astra 2A is successfully launched this month (August) there is plenty of action from Astra 1D. A test card in PAL to assist antenna alignment can be found on 11.992 GHz (H). The transponder line up as we closed for press looks like this (All sigs are FEC 2/3 & SR 27500) ;

- 11.720 H BBC 1 England, BBC 2, News 24, BBC 1 NI + 2 test cards
- 11.740 V Flextech
- 11.758 H The Box (currently on Astra 1A with G. Plus and Men/Motors)
- 11.778 V 50 Music Choice Europe channels
- 11.798 H BBC 1 Scotland, BBC 1 Wales, + 3 test cards
- 11.817 V Flextech
- 11.837 H Sky Box Office (5 channels), Sky Movies Screen 1 & 2, Sky One, Sky Sports 1

- 11.856 V National Geographic, Sky Box Office (5 channels), Sky Sports 2, Sky Movies Screen 1A & 2A (NVOD channels)
- 11.876 H Sky News, Sky Movies Gold
- 11.895 V Sci-Fi Channel, Sky Movies Gold A (NVOD), Nickelodeon, Paramount
- 11.914 H Sky Box Office (5 channels), Sky Sports 3, Sky Novies Screen 1B & 2B
- 11.934 V Not active (late June)
- 11.954 H Granada Plus, Bloomberg, Men / Motors
- 11.973 V Sky Soap, Tara, Fox Kids
- 11.992 H PAL test card
- 12.012 V Not active (late June)
- 12.032 H History Channel. [.tv], Good Life, The Racing Channel
- 12.051 V Previews 1 & 2, MTV, VH-1

BBC channels will be encrypted but they will provide free smartcards for anyone who wants them. Four different smartcards will be made available, depending on whether you live in England, Northern Ireland, Scotland or Wales. Further channels, in addition to BBC 1, BBC 2 and News 24 will include BBC 1 Widescreen, BBC 2 Widescreen, BBC Choice and BBC Learning Zone.

NTL has been awarded the contract to uplink the BBC's new digital satellite television broadcasts. Fibre connections will carry feeds from the BBC TV Centre in London to NTL's satellite teleport near Winchester. From there NTL will uplink two digital multiplexes via two separate antennas for maximum back-up and reliability.

OFF AIR

WTN Feed on Eutelsat IIF1 12.558 GHz (H) SR 5632 FEC 3/4.

Conclusion

That's it for this time. With editorial constraints on space the postbag has been held over together with details of the embarrassing news that after advising all and sundry to hold off buying a digital receiver, yours truly has been having fun with his new Nokia 9600. Space permitting next time I will bring you some first impressions of this receiver and the excellent new PACE MSS466G Pal/D2Mac receiver which has also found it's way into the shack. For those also experimenting with digital or any other topic please write or call and pass on your experiences. as usual the e-mail is paul.holland@btinternet.com , telephone 01948 770476.



Circuit Notebook No. 64**By John Lawrence GW3JGA****Modifying the Maspro SRE-90R for ATV Portable Use**

The bulk of the following text has been extracted from a set of modification notes, having the above title, produced by David Ellis Jones, GW8PBX, for the purpose of getting newcomers and not-so-newcomers into portable ATV operation on the 24 cms and 3 cms bands.

The Maspro SRE-90R satellite receiver is ideal for receiving fast scan amateur TV on the 23-24 cm band with or without a pre-amp and on 3 cms with a suitable LNB. It has good sensitivity and for local working on 24 cms it can often be used without a pre-amp. However, in unmodified form, the LNB supply voltage is always present on the 'F' input socket and this must be disabled when connecting directly to a Yagi or similar aerial which would otherwise short circuit the supply. See step 7.

The remote control allows the receiver to tune the range 950-1750 MHz in 1 MHz steps and the last three digits of the tuning frequency, in MHz, is displayed on the front panel readout (e.g. 249 = 1249 MHz). The intercarrier sound frequency can also be tuned in steps of 10kHz by the remote control and again the frequency is displayed on the readout.

Two versions of the SRE-90 exist, the R version with mono sound and the S version with stereo or two-channel sound. These notes cover the R version only. As well as having additional sound circuitry, the S version makes extensive use of a -12 volt rail. Hence, modifying the S version requires a totally different approach that is not covered here.

Modifications

The mains PSU in the SRE-90R provides the following supplies:

- (a) +12V for general audio and video processing
- (b) 2 off +5V rails for the processor, front panel display and some audio processing
- (c) +15V to power an LNB via the 'F' RF input socket of the tuner unit
- (d) -12V for polarisation switching using external devices
- (e) +30V reference rail for the main tuning supply

The following modifications enable the receiver to be used for ATV portable operation by discarding or replacing some of the above supply rails and by running directly from a 12V battery.

Supply (a) is taken from the 12V input supply

Supply (b) remains

Supply (c) is taken from the 12V input supply

Supply (d) is discarded

Supply (e) is generated by a dc-dc converter module

All references to component positions on the main PCB refer to the plan view with the front control panel facing you.

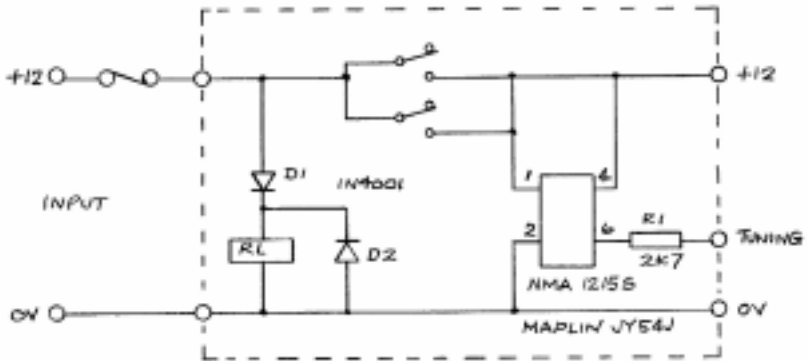

Figure 2. Circuit diagram

1. Unplug the connection from the mains transformer assembly to the main PCB P401-402 (bottom right). Retain the plug for use later by cutting off near the transformer end. Note that pin 1 is nearest to the corner of the main PCB - nearest to the transformer.

2. Disconnect the mains input wiring from the mains transformer, remove and discard the transformer and its PCB. Retain the existing fuseholder for use with 12V, but replace the fuse with one of 1A slow-blow (20mm).

3. Make up the Veroboard panel as shown in Fig.1. This carries the dc-dc converter for the main tuning supply and the optional reverse-polarity protection relay. The relay used is a National NF2-12V but almost any 12V type would be suitable, but the pin connections may be different. The circuit is shown in Fig.2. The panel can be supported on pillars using the fixing holes vacated by the transformer. If the reverse-polarity protection is not required then the relay and associated diodes may be omitted and the +12V input linked directly to the +12V output.

4. Connect the 12V input (via the fuse) to the +12V and 0V input connections on the Veroboard. Connect the 12V output connections to the

P401 plug, (retained from stage 1) with the +12V output to pins 1 and 5, and the 0V (ground) to pin 2.

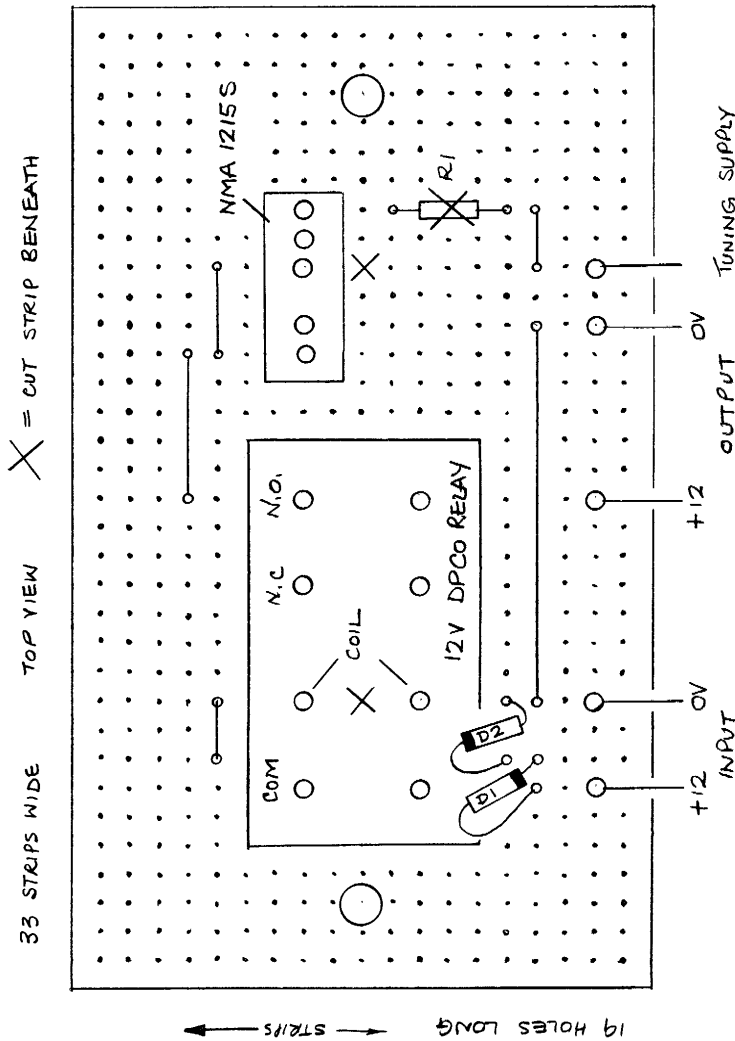

FIG. 1. VEROBOARD LAYOUT

5. Locate the 7812 voltage regulator (IC 403) at the left of the main PCB, it is the furthest away of the four voltage regulators. Cut the output wire link, the furthest away of the three, leaving as much wire on the main PCB side as possible. Connect a wire from the main PCB side back to the +12V output from the Veroboard panel.

6. Connect the Tuning Voltage output from the Veroboard panel to the lower end of R401, (i.e. the end nearest to the front panel). R401 is located

at the lower right corner of the main PCB. The tuning voltage is produced by the dc-dc converter (30V) sitting on top of the 12V supply, giving +42V, which is reduced by the 2k7 ohm series resistor on the Veroboard to approximately 35V.

7. Locate the 7815 voltage regulator (IC 404) at the left of the main PCB, it is the nearest of the four voltage regulators. Cut the output wire link from the regulator to point W412, leaving as much wire as possible on the W412 side. This is the voltage feed point to the RF input 'F' connector. If you always require the supply voltage present on the RF input 'F' connector then connect point W412 to the +12V output from the Veroboard panel. Alternatively a switch could be connected in series to with this wire to control the +12V feed. The switch could be mounted on the back panel.

The following modifications are worth undertaking:

6 MHz Sound Trap

The original receiver, although having tunable sound, was generally used for the (then) main Astra sound channel of 6.5 MHz. This was notched out of the video chain with a tuned filter. For ATV use this needs retuning to 6 MHz to remove residual sound sub-carrier from the video. Near the middle of the main PCB there is an integrated three-can filter with one adjustable core. Carefully adjust this to the bottom of the can. This does not quite tune down to 6 MHz but gives a noticeable improvement to the output video.

Video Output Level

On a known good ATV signal, adjust VR 304 (located in the middle of the board, the pre-set furthest from the front panel) for 1V peak-to-peak video into 75R. It just makes it !

Video H.F. Response

The colour sub-carrier level can be increased by applying frequency compensation across the 75R launch resistor (R 346) in the video output stage. In the prototype a 1nF ceramic capacitor was used. This was soldered (with difficulty) directly across the resistor on top of the board. Look for a tiny 75R resistor running front to back near the video output socket.

The Maspro SRE-90R can still be found at Rallies and surplus sales and is good value at around £10 for a working unit providing it includes a remote control. The remote control is required initially to set up the tuning and sound IF frequency but once the channels have been allocated the receiver can be controlled from the front panel buttons.



In retrospect

Since sending you my article on panel antennas, I have made another 4 bay array. In doing so I have found an error. In drawing 3, the lengths of the arms should be 34mm not 22mm as shown. With too short arm lengths, the optimum match occurs above the band. The increased length corrects this.

I have also done a swept frequency measurement of the match.

The antenna is optimised for the repeater input frequency of 1249MHz and the match is well within 1.5:1 over the input channel of ± 8 MHz of this frequency. The match is not so good, about 3:1, at the repeater output frequency of 1316MHz, but match does not seem to be a very significant factor for antennas used for reception.

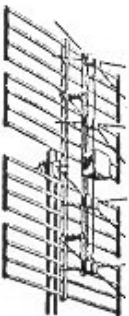
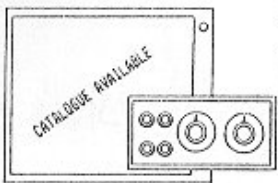
HS PUBLICATIONS
7 Epping Close, Derby DE22 4HR, England
☎ 01332 38 16 99



- **DX-TV CONVERTERS** • **VHF-UHF TV AERIALS**
- **DX-TV PUBLICATIONS & VIDEOS**
- **AMPLIFIERS** • **FILTERS** • **HARDWARE**
- **TECHNICAL BOOKS**
- **BBC TEST CARD MUSIC C.D's**
- **TV CLOCKS & ARCHIVE PUBLICATIONS**

Send 3 First Class stamps for our latest Catalogue
Personal callers by prior arrangement only please.

Forward reading signal meter for the TVRO3, Dove RX/IF units.

Bob Platts, G8OZP

The Dove and TVRO3 Rx / IF units have the facility to drive a signal strength meter. The meter signal is derived from the tuner AGC. voltage which decreases with increasing signal. This means that the meter indicates in the reverse fashion. The stronger the signal the less the meter moves. Whilst this is not a problem it is not the norm now a days.

This simple circuit provides a signal strength indication in the more modern forward fashion. The greater the signal the greater the meter deflection.

The circuit could readily be constructed on Vero board and

attached to the meter or in any spare space available. The design could no doubt be made to work on other RX units that have the AGC voltage that covers the range of about 5v to 0.5v DC.

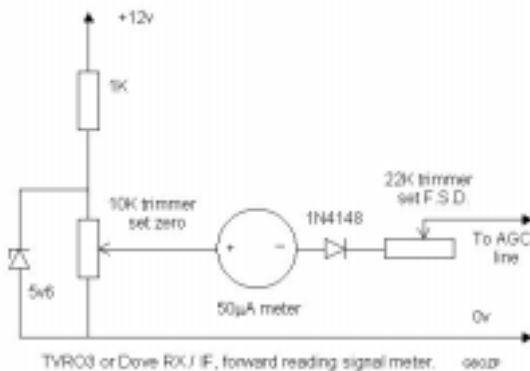

Connections to the RX units are.

	TVRO3 RX / IF unit	Dove RX / IF unit
Connection	Connector / pin	Connector / pin
+12v	Con 2 pin 1 or 2	Con 7 pin 1
0v	Con 3 pin 5 see note	Con 5 Pin 3 see note
AGC line.	Con 3 pin 9 see note	Con 5 Pin 1 see note

Note. These pins connect to the original signal meter – and + terminals. R17 on the TVRO3 will need to be shorted out.

Setting up. Without a signal on the input but with your pre amp or LNB connected adjust the 10k trimmer unit the needle just starts to move. Tune in a strong local signal and adjust the 22k trimmer for full scale.

With other types of RX the 22k trimmer value may need to be increased.

How we (nearly) played ghost on Auntie

By Ian M Waters, G3KKD

The year is 1952, the BBC television service is expanding. Using new technology in the form of high sensitivity compact Image Orthicon cameras and microwave links, outside broadcasts are being made which would have not previously been possible. There was a series of broadcasts in which Richard Dumbleby visited famous buildings. One such broadcast was planned from Ely Cathedral.

Before going on with our story we must remember what things were like in those days. Television really meant the BBC. There was as yet no ITV, no CCTV and certainly no video cameras in many people's homes. Few people knew anything about television transmission technology and apart from the BBC and the three manufacturers, EMI, Marconi and Pye, there were only perhaps five privately owned cameras in the country, made by members of the BATC.

I lived in Ely where my father was the manager of the Electricity Board. At an early stage in planning, the BBC approached him to find out how much power could be made available in the cathedral. I and our group of other lads interested in ATV therefore knew all the plans a long time in advance. We knew that the OB van or scanner, MCR 10 with IO cameras, was to be parked outside the South door through which camera cables and mic lines would enter the building. The video and audio lines, carrying the output from the vehicle, were to pass over a wall, through the Bishop's garden to a links vehicle parked below the West tower. A dish, high above, would send the signal via a repeater on Barkway ridge to master control in London.

So a plot was hatched. I had one of the few ATV cameras, a Photicon, a photo of which appeared in a recent issue of CQ-TV. This was to be moved, under cover of darkness, to the cellar of a house in the College quite close to where the scanner was to be parked and where one of our ATV group happened to live. An aerial was to be erected to feed a receiver also in the cellar. Pulses from the scan flybacks were to be used to trigger line and field ramp generators. Voltage comparators connected to these ramps would trigger pulse generators such that their outputs could be adjusted to have variable delays with respect to the received syncs. These pulses would drive the camera chain.

The camera would be looking at a black cloth. The cellar would be in darkness except for one small pinpoint of light in the top right corner of the scene like a cue dot. The most difficult and dangerous part of the

How we (nearly) played ghost on Auntie

enterprise was the connection of our contribution into the BBC's transmission. The output signal from our camera was to go up through a grating out of the cellar via a long length of well concealed coax to a point hidden in the bushes of the Bishop's garden.



MCR 10 outside the South door of Ely cathedral in September 1952

The broadcast took place after dark. One member, connected to the cellar by a telephone headset was to lurk in the bushes. He was to remove the outer sheath of the BBC coax, part the braid, extract the inner and remove a piece of insulation. He had to be careful not to cut the cable! This action would not impair the BBC transmission. We had a copy of the BBC script, so we could chose the scene in which our ghost was to appear. When this time came, the man in the bushes was to connect the end of our cable via a resistor and a croc clip to the BBC cable inner.

If all went well we expected that we would see a small spot of light, our cue dot, appear somewhere in the picture we were receiving off air. We

would see it because we were looking for it but we hoped others would not notice it. The phasing controls would then be rapidly adjusted to move the cue dot to the top right hand corner of the picture. The ghost, another member in a grey hood and cowl, would then pass across the field of view, taking about half a second to do so. Our contribution would be of low amplitude and rather blurred but that would be all the better.

The connection would then be removed, the BBC cable taped up and our cable quickly reeled in. We would all then go to earth and await the newspapers the following morning! Unless the engineers in the scanner were looking at the radio check receiver, they should not be aware of the ghost as it was connected downstream of the transmission monitor. We thought they would not be using radio check, as reception at that site was poor. We doubted that there would be any picture monitor in the links van so the first people to see it would be at master control in London.

They would call the scanner and say, “what was that?” the scanner would say “what? We saw nothing”. It would probably remain a mystery until the next day when they were de-rigging and found where their cable had been tampered with. Even so, we wondered if they would ever think that they had been the object of such a technical hoax.

In the event we did not do it. Frankly, after dwelling on the possible implications of getting caught, we got cold feet. It was well known that I possessed a television camera, it had been featured recently in the local newspaper. If it were not in its usual place in my shack we would have some talking to do. As it was bulky we could not quickly bring it home, the BBC would be certain to see us. We doubted if the cathedral authorities would see the joke. The cellar belonged to a house in the college occupied by one of the Canons. Our member’s widowed mother was his housekeeper. There seemed to be a real risk that she might get the sack and both of them be out of house and home. Then what would our employer, Pye, think? They had helped us a lot in making the camera. On the engineering side they would have to administer a rocket, but on the quiet they would see it as a huge joke and perhaps commend us for our technical ability, assuming that we ever told anyone just how it had been done. The management was however another matter and we did not want to ruin our careers which were just starting. If we were caught what would the charge be when the case came up at Ely magistrate’s court? Illegal broadcasting? Tampering with BBC property?

Perhaps we should have done it, we might with good conduct be just about emerging now from the Scrubbs.

In case you think this is a pure figment of the imagination, the illustration shows MCR 10 outside the South door of Ely cathedral in September 1952.

DIGITAL FREQUENCY DISPLAYS

The DFD series of Digital Frequency Display Kits is a range of microcontroller based units with a whole host of features. From a stand-alone frequency counter up to 3 GHz, to a user programmable package with enough features to blow your socks off.



DFD1: A high-quality microcontroller based unit capable of measuring up to 32 MHz as a basic unit (up to 8 GHz with prescaler), or by setting an offset with a trimpot it can be used as the freq display of a TX or RX by \pm the offset from the LO. 16 character LCD with 100 Hz resolution - e.g. 14.257 MHz USB - the mode is set by external R's and can be programmed for AM, FM, CW, USB, LSB, FSK, FAX or left blank.

DFD2A: This unit has a similar specification to the DFD1 but with an enhanced resolution of 10 Hz. Modes available are also as the DFD1 but without SSB.

DFD3: A remarkable unit with an EEPROM at its heart and a flicker free 10 Hz resolution. This device, by simply connecting to the VCO of your radio, can display the exact transmit/receive frequency. Any offset from the selected frequency due to crystal drift can be calibrated into the EEPROM where it is stored for eternity.

The only external components required are one 10k pot, one SPDT biased centre-off toggle switch, three SPST pushbuttons, two 10k resistors and one 1k. These components allow selection of the various display and programming modes of the device.

BUT THE MOST REMARKABLE thing about the DFD3 is that it will program itself for many popular radios. Already stored in the EEPROM is the data for over 75 of the most popular radios on the market, and if your radio is not on the list you can easily program the data in.

DFD4: This unit has a built-in prescaler which is good up to 3 GHz. It has 4 modes of operation:

- MODE 1 HF FAST: max input frequency 30 MHz, resolution 10 Hz, gate time 0.1 sec
- MODE 2 HF SLOW: max input frequency 30 MHz, resolution 1 Hz, gate time 1 sec
- MODE 3 UHF FAST: max input frequency 3 GHz, resolution 1000 Hz, gate time 0.128 sec
- MODE 4 UHF SLOW: max input frequency 3 GHz, resolution 100 Hz, gate time 1.28 sec IF offset is programmable from ± 0 to 2 GHz in 1 kHz steps.

Back Lit Versions

DFD1 £42.46 + VAT
DFD2A £43.50 + VAT
DFD3 £42.46 + VAT
DFD4 £51.17+VAT

DFD1BL £50.46 + VAT
DFD2ABL £51.50 + VAT
DFD3BL £50.46 + VAT
DFD4BL £66.17 + VAT



**Mainline Electronics, P.O. Box 235,
Leicester, LE2 9SH**



Tel: (0)116 277 7648/278 0891 Fax: (0)116 247 7551

Email: sales@mainlinegroup.co.uk



Please send all correspondence for **Post and News** to the CQ-TV Editor. Ian Pawson, 14 Lilac Avenue, Leicester, LE5 1FN, England.

Tel: 0116 276 9425.

E-mail editor@batc.org.uk

Members sales and wants should be sent to the editor at the above address.

Trade adverts should be sent to the advertising manager,

Chris Smith,

E-mail adman@batc.org.uk

Auckland ATV Notes #10, May 1998

The monthly 70cm ATV Net on the 70cm National System is to be held on Wednesday evening the 27th May. Because of the expected heavy traffic with the Conference award the ATV Net will start early at 7.45 pm. 8 pm to 9 pm is the award net. After 9 pm the ATV Net can recommence for those who weren't able to be there earlier.

Grant ZL1WTT is the net control but has a iffy 70cm rig, so start calling without him if his rig lets him down & he can rx only.

Wayne Griffin ZL1UJK (09-5289118) has produced a set of PCBs to use with 23cm hybrid modules M67715 & M57762. They cost \$20 a pair. The modules are from the Wellington VHF Group (or can be had from RF Parts in California).

Ian ZL1VFO & Grant ZL1WTT have produced some new graphical designs (a dragon, pc monitor & human figure) for the Teletext video generator (ATV Compendium - BATC). If you'd like a copy email to: ian.pople@dse.gen.nz Ian is developing (with Grants help) an additional 16 pages for the ZL1BQ repeater. Using 27c512 EPROM 32 pages can be cycled through the beacon mode display.

The ZL1BQ ATV Repeater now has a 23cm FMTV receiver in addition to the 70cm one. The performance needs improvement as it is getting swamped with stray signals. Interdigital filters are being considered.

The ZL1UX repeater has been shifted to a cabinet next to the meeting room in the Hamilton clubrooms. A noisy psu transformer was replaced after the Cambridge market day. Wayne ZL1UJK is working on a new 70cm RX and Teletext video generator. Bill ZL1BRI is putting an Alford Slot aerial together for omni horizontal radiation on 615 MHz.

73, Michael Sheffield ZL1ABS, 176 Albany Highway, Albany, Auckland, NZ 1331, = phone 00649 4159584; email zl1abs@xtra.co.nz Pcket ZL1ABS@ZL1AB.#11.AKL.NZL.OC

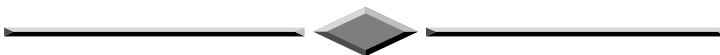

The Konkan Adventure Club and Radio Society
Ghatle New Municipal Colony D1/4, Chembur, Bombay 400 071

Dear Sirs,

We are trying to establish our own ATV equipment. We want to assemble ATV transmitter article from 73 Amateur Radio Today, August 1992. A 1 watt transmitter. We have 1st part with us. As you are in the same land, and having ATV club, you might have this article with you. It is written by Mr. William Sheets, K2MQJ and Mr. Rudolf F. Graf KA2CWL.

We will be very thankful to you if you can provide 2nd part of this article, or any other circuit diagram & constructional details for ATV transmitter and receiving converter. We already contacted to editor of 73 Radio Amateur Today, but not heard any thing from him as yet. We hope you will help us.

Yours faithfully, Mr. Prashant M. Thakur, Chief Flight Instructor.

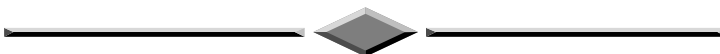

Contributions.

If you have any snippets of news or information, then please send them in to my the editor either by snail mail or email

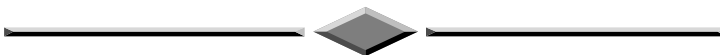

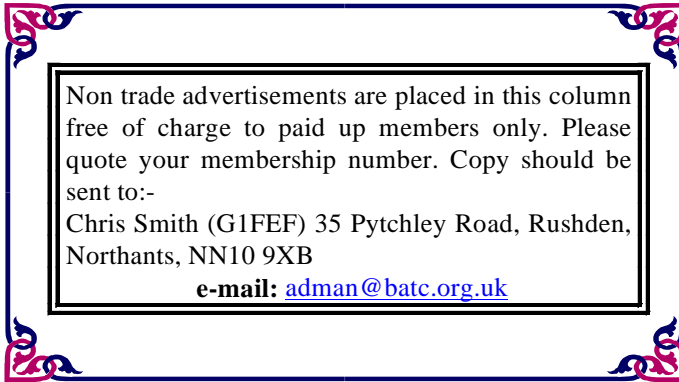

For Sale

CQ-TV magazines (BATC), 15 years 1983 – 1997 £1.00 per year

Datacom magazines (BARTG) 17 years 1981 – 1997 £1.00 per year

VHF Communications magazines, including binders, 24 years 1972 – 1997 £10.00 per 3 years inc. binder

The German UHF Compendium part ¾ (English version) £10.00

ARRL Handbook 1993 (Hardback) £8.00

Various BATC/BARTG publications:- CQ-TV ATV handook Vol. 1 and Vol2, Micro and TV Projects, ATV Compendium, BARTG 'RTTY the easy way' £1.00each of all 5 for £4.00

NEC PC8201 Laptop computer, including mains adapter, handbooks, plugin 32k RAM pack. It has a 40col by 8 line LCD display. 3x32k bank RAM, total 96k. Built in ROM software per bank for wordprocessing, BASIC, telecom serial communications. Size 12x9x2.5. In good working order £50 ono.

Contact Mick Curran, G4ITF on 01705 386184 for further details.

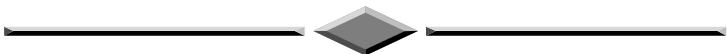

ZLIUJK June 1998 Sale

- 1) ATV Transmitter 70cm VSB (note was not a Wellington VHF Group kitset) with circuit info Have reduced from \$350 to \$225 ono
- 2) National U-Matic / VHS Editor remote controller unit \$250 ono
- 3) Ampex 1/4" multitrack tape deck. Nice tape deck in working order \$300 ono
- 4) AM/FM Radio tuner Marantz excell cond & working order \$45 ono
- 5) Akai Stereo cassette deck logic control working order \$150 ono
- 6) Satellite TVRO unit Scientific Atlanta 110 VAC not working \$20
- 7) UHF TV Aerial high gain as new \$55 ono
- 8) Sony video monitor with A/V SCART 20" model KX-20psi has minor fault not working but is repairable \$20
- 9) Sony 12" colour tv, no A/V input \$45 ono
- 10) Jaycar Silicon Chip Audio 4 channel mixer kit \$25
- 11) Sony U-matic player minor fault \$35 ono
- 12) BAYCOM packet kit built up & software \$25
- 13) PYE 22" colour tv \$35 ono
- 14) NTSC 6" colour TV with A/V inputs 12 volt powered \$175 ono
- 15) Digital alarm clock radio / shack clock \$10
- 16) Revox A700 Audio reel to reel tape deck stereo has minor fault \$125 ono
- 17) Book on Microcomputer colour graphics system \$2

**Reply to: Wayne Griffin ZLIUJK PO Box 28-300, Remuera, Auckland.
Phone 09-5289118**

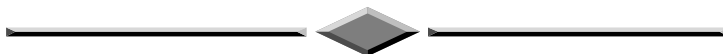

TELEVISION BY DESIGN. 1961. Richard Levin. Superior and lavishly illustrated book about tv design, lighting, sets, studios etc. Many photographs, some in colour. D/w. Sought-after book. Usually sells for £30+. DH price **£15** INTERNATIONAL TELEVISION ALMANAC 1985. Quigley Pub USA. Loads of facts about US tv. All the stations. First stop WHMA-TV. **£5** SCREEN INTERNATIONAL FILM & TV YEAR BOOK. 1982-3. **£3** SEE IT HAPPEN. Making of ITN. G.COX..

Fascinating account of the start of ITN. Illustrated. d/w. **£5** THE TECHNIQUE OF TELEVISION PRODUCTION. Millerson. 1979. Illustrated. **£5**. TELEVISION ENGINEERING. Pt 1. Fundamentals. Broadcast, cable, satellite. R.S.Roberts. RTS Publications. 1985. **£3**. ATV SHOW BOOK 1960. Lots of pictures of ATV shows! **£5**. BBC YEARBOOK 1949. D/w. tatty **£5** BBC HANDBOOK 1958 d/w **£5** BBC HANDBOOK 1959. D/w with section of rear top missing. **£5** TV UNFORGETTABLES. Over 250 legends of the small screen. Anthony & Deborah Hayward. Guinness p/b 1993. **£2** GIRL FILM & TV ANNUAL No. 1. 1957. First issue of this attractive series. No. d/w. **£3**. All items in VGC. Postage minimum **£1**. **Contact Dicky Howett. 01245 441811. Email: Dicky.Howett@btinternet.com**

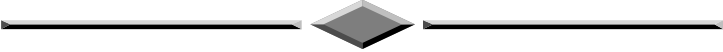

6ft High, 19 Inch rack mounting instrument cabinet on castors, professional type, removable side panels, rear door, £25 Buyer collects. **Derek Dunn G8KOV on 01453 546971**

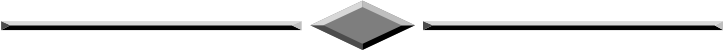

Philips Laservision player model VP600, in working order with a few disks and a service manual, prefer buyer collects £30.00 Philips video 2000 microprocessor diagnosis system, with manual. Used to diagnose faults on VR2020/VR2022 etc £10.00 Several VR2020/VR2022 Video heads, open to offers. Also a few heads for Sony C5, C6, C7. Open to offers. **Contact: Chris Kentch G0FJY on 01903 240147 QTHR**

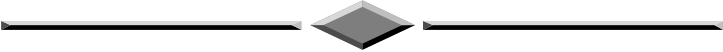

Amiga 1500-2000/386PC, Two computers in one case! 7MB RAM (Upgradeable), four x 2 1/2" floppy drives (3 Amiga + 1 x 1.44MB PC Floppy), 2 hard drives (1 x 40MB, 1 x 81MB), ROM sharer (Workbench 1.3/2.5), Trident 512KB VGA card, SCSI controller card, Vortex golden gate PC emulator board (The best PC emulator PCB available for the Amiga, runs DOS 6.2, Windows 3.1, etc) Commodore 1081 monitor, Citizen 120D printer, Master sound, sound sampler, Roboshift automatic mouse/joystick switcher interface, Cyclone cloning interface & software, keyboard, mouse, several joysticks, an absolute mountain of software, far too much to start listing any titles (including some amateur radio software), cost over £1600 when new. Ideal for ATV use! £335 the lot

ONO. Contact: Mark Hopkins on 0181 648 3540 (eves/weekend) or 0411 621508 office hours.

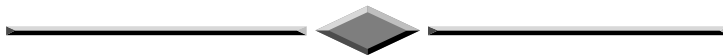

BETAMAX SONY C5E VIDEO RECORDER	£20.00
VHS FERGUSON VIDEOSTAR VIDEO RECORDER REMOTE CONTROLL	£65.00
COMPUADD 14" VGA COLOUR MONITOR	£45.00
AVO 8 MARK 5	£75.00
KHP 30 HIGH VOLTAGE PROBE	£15.00
TRINICON COLOUR CAMRA	£60.00
SANYO CAMCORDER , LEADS 2 BATTS CHARGER	£125.00
HMV 405 B/W PORTABLE T/V COLLECTORS ITEM	£15.00
AIRMEC NORMENDE COLOUR PATTERN GENERATER	£75.00
PRISM 1000 MODEM	£5.00
MICRON AX/2400 MODEM	£10.00
12" COLOUR PORTABLE T/V HITACHI	£75.00
14" COLOUR R.G.B. MONITOR	£75.00
5" B/W NAT PAN T/V	£10.00
CHROMASCOPE P135 4/VIDEO INPUTS FADER CONTROLL ECT	£75.00
MICROWAVE MODULES FREQUENCY COUNTER	£50.00
V.L.F. CONVERTER	£15.00
6 METRE CONVERTER	£15.00
70 CMS ATV CQTV TYPE CONVERTER WITH BUILT IN PSU	£10.00
3.5 MHZ TO 150 MHZ VSWR METRE	£15.00
DATONG MORSE TUTOR "MODEL D70"	£35.00
REALISTIC 6 CHANNEL HAND HELD TYPE SCANNER	£5.00
MICROWAVE MODULES 70 CMS ATV DOWN CONVERTER	£45.00
3.5 MHZ TO 150 MHZ VSWR METRE	£5.00
FORTOP 70CMS ATV RX/TX	£100.00
MICRO HEAD BOXED LARGE	£10.00
MICRO HEAD BOXED SMALL	£5.00
9 VOLT/500MA P/S/U	£2.00
CQ TV TYPE CALLSIGN GENERATER WITH BUILT IN P/S	£35.00
PHILLIPS MONO CAMERA WITH P/S	£45.00

PHILLIPS PERDIO MAINS/BATT 405 T/V COLLECTORS ITEM	
	£50.00
VHF LINEAR NEEDS REPAIR 75 WATTS	£10.00
PYE CASE TYPE BATT RADIO COLLECTORS ITEM	£25.00
DRAE 13.5 VOLTS 12 AMP P/S	£50.00
SANYO BETAMAX VCR	£25.00
14" COLOUR TX9 T/V WITH VIDEO/AUDIO IN/OUT	£50.00
SINCLAIR SPECKTRUM 48K BUILT IN DK/TRONICS KEYBOARD WITH TAPE RECORDER plus SOFTWARE TWO SPEKE TYPE PRINTERS plus OTHER HARDWARE	£75.00
TRIO 9000 VHF ALL MODE TRANSCEIVER	
TRIO P/S 20 POWER SUPPLY	
TRIO B0/9A SYSTEM BASE	
TRIO SP120 SPEAKER, LOT PRICE,	£350.00
TRIO 9500 UHF ALL MODE TRANSCEIVER	
TRIO P/S 20 POWER SUPPLY	
TRIO B0/9A SYSTEM BASE	
TRIO SP120 SPEAKER, LOT PRICE,	£400.00
HEATHKIT DAYSTROM AF/RF SIG GEN	£45.00
HEATHKIT C3U R-C BRIDGE	£40.00
12 TO 15 VOLT 10 AMP P/S	£35.00
12 TO 15 VOLT 7.5 TO 14 AMP P/S	£35.00
70 cms PREAMP KIT STILL IN BOX	£5.00
BBC B COMPUTER WITH TWIN DISK DRIVES AND PLINTH + LOTS OF SOFTWARE ECT	£100.00

**PHONE NO: 0181 304 3992 PLEASE CALL AFTER 6PM
WEEKDAYS OR ANY TIME WEEKENDS. BRIAN JOHN BEAN,
G6PKS QTHR.**

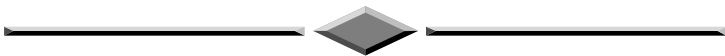

Signal generator HP626A, GWO 10 - 15GHZ -£70

US army Signal generator TS155 c/up 10cm - £40. **Contact John Price on
01883 17484**

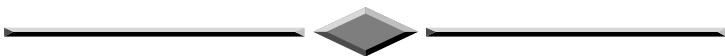

CQ-TV Magazines from Feb '92 to date, complete £20 ono, 4" B&W
Monitor 12/240 Volt vister compact, as new £65 **Contact: P. Bedford
0181 747 0069**

Wanted

Circuit or info for a VIDEOMATTE VM1 vision mixer which I purchased at the rally, a bargain but needs some TLC. Also wanted, a head for a Toshiba V9600B Betamax VCR, or if not, does anyone want this VCR that only needs a head - for free (collect). **Contact: John Cronk, G3MEO 01745 888355 2 Mostyn Ave, Prestatyn, Clwyd, LL19 9NF**

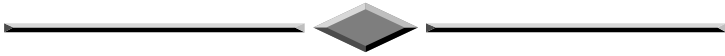

IKEGAMI 79D camera parts. Especially needed, power leads, batteries. Sync, DTL and coder boards. Also, working power supply for LDK5 camera. **Contact Dicky Howett 01245 441811. Email: Dicky.Howett@btinternet.com**

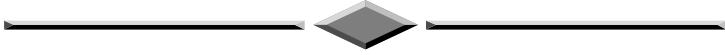

N1500, N1700 and Grundig SVC service manuals + N1500 instruction manual desperately wanted after my original copies were destroyed. I am willing to pay the going rate plus postage from anywhere in the world. Also wanted N1500, N1700 and Grundig SVC parts, tapes, machines etc. **Telephone Mike Bennett G7TRF on 01395 279732 or E-mail mdb2@permanent.co.uk 3 High View Gardens, Exmouth, Devon, EX8 2JR Phone 01392 449291 (Daytime)**

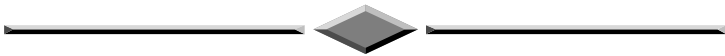

Manual and power supply unit for a QUESTTECH 2101P Frame Syhchroniser. (I believe the power supply type is a POWERTRON QT 1,also used in the 2201P) Also looking for an SPG. **Please contact:- Mark Killingback on 01223 892062 or Email killingb@global.net.co.uk**

Index of Advertisers

- Caladan Communications46
- GB3XT Kits and Bits.....19
- HS Publications.....79
- Mainline Electronics**84
- Severnside Television Group68
- VHF Communications62
- Worthing & Districe Video Repeater Group.....59