

Contents

Contents	1
Committee Contacts.....	2
Editorial.....	4
I.B.C Review	4
Rotator Zebedee	7
A Common Date/Time Standard for Amateur Radio:.....	9
The Nature of Video, part 1.....	13
Update on ATV repeaters.....	24
TV on the Air.....	25
Deadline	29
GW ATV Demonstration	31
Satellite TV News	34
An American in ANTA (the French ATV organisation)	46
ATV via MIR	50
Experimenting with Video	57
Circuit Notebook No.62.....	73
Subscription Renewals.....	76
Open Video Festival	77
PIC Dream	79
First Passed the Tape.....	81
Flat Plate Aerial.....	86
Post and News	88
For Sale	92
Wanted.....	95
Index of Advertisers.....	96

CQ-TV is produced on a P6 Gateway 2000 PC computer system, using the Word for Windows word processing package. The camera-ready artwork is produced on an Hewlett Packard LaserJet 4 printer.

Edited by Ian Pawson, circuits drawn by Allan Robinson, proof read by Peter Delaney. All rights reserved, all wrongs denied.

© 1997 by the BATC.

Printed by *Cramphorn Printers Ltd.*, 15c Paynes Lane, Rugby, CV21 2UH, England

Committee Contacts

BATC Chairman: Trevor Brown G8CJS

Club affairs, Video tape library, Technical queries, especially relating to handbook projects. 14 Stairfoot Close, Adel, Leeds, LS16 8JR. Tel: 01132 670115. E-mail: chairman@batc.org.uk

BATC General Secretary: Paul Marshall G8MJW

General club correspondence and business. Library queries relating to the borrowing or donation of written material. Fern House, Church Road, Harby, Notts., NG23 7ED. Tel: 01522 703348.
Email secretary@batc.org.uk

BATC Hon. Treasurer: Brian Summers G8CQS

Enquiries regarding club finances, Donations, and constitutional enquiries. 9 Prior Croft Close, Camberley, Surrey, GU15 1DE. Tel: 01276 677879, Mobile 0850 014892

CQTV Magazine: Editor Ian Pawson

Anything for publication in CQ-TV, Articles, Review items, Letters to the editor, and other material except as below. 14 Lilac Avenue, Leicester, LE5 1FN, England. Email: editor@batc.org.uk

Photographs for the CQ-TV covers:- Please send any photographs by post, electronic images by email, to the editor at the above addresses.

TV on the Air:- Graham Hankins G8EMX, 11 Cottesbrook Road, Acocks Green, Birmingham, B27 6LE. Tel: 0121 707 4337

Satellite TV News:- Paul Holland G3TZO, Chatterton, Chapel Lane, Threapwood, Nr. Malpas, Cheshire, SY14 7AX. Tel: 01948 770429, Email: satnews@batc.org.uk

CQ-TV Advertising Manager: Ian Pawson, 14 Lilac Avenue, Leicester, LE5 1FN, England. Tel: 0116 276 9425. Email: adman@batc.org.uk

CQTV Awards:- Bob Webb G8VBA, 78 Station Road, Rolleston on Dove, Burton on Trent, Staffs., DE13 9AB. Tel: 01283 814582

Exhibitions

Mike Wooding G6IQM, 5 Ware Orchard, Barby, Nr. Rugby, CV33 8UF.
Tel: 01788 890365, Fax: 01788 891883, Mobile: 0860 857434
Email: rally98@batc.org.uk

Club Sales

Members Services:- PCB's, components, camera tubes, accessories, etc. (NOT PUBLICATIONS). Peter Delaney G8KZG, 6 East View Close, Wargrave, Berkshire, RG10 8BJ. Tel: 0118 940 3121

Publications:- Handbooks, Back copies CQTV, and anything related to the supply of BATC publications. Paul Marshall, Fern House, Church Road, Harby, Notts., NG23 7ED, England.

E-mail: publications@batc.org.uk

Membership

Anything to do with membership, including new applications, queries about new and existing membership, non-receipt of CQ-TV, subscriptions, membership records, data protection act. Dave Lawton G0ANO, 'Grenehurst', Pinewood Road, High Wycombe, Bucks., HP12 4DD. Tel: 01494 528899. E-mail: memsec@batc.org.uk

Club Liaison:- And anything of a political nature, co-ordination of ATV repeater licences. Graham Shirville G3VZV, The Hill Farm, Potsgrove, Milton Keynes, Bucks., MK17 9HF. Tel: 01525 290343. E-mail g3vzv@amsat.org

Contests:- Richard Guttridge G4YTV, Ivy House, Rise Road, Skirlaugh, Hull, HU11 5BH. Tel: 01964 562498

BATC BBS Sysop:- Brian Kelly GW6BWX, 12 Cotswold Way, Risca, Gwent, NP1 6QT. Tel: 01633 614376, BBS: 01633 614765. E-mail: bbs@batc.org.uk

Repeater Liaison:- General enquiries and repeater affiliation. Graham Hankins G8EMX, 11 Cottesbrook Road, Acocks Green, Birmingham, B27 6LE. Tel: 0121 707 4337.

BATC web master

Anything to do with the BATCs web site. E-mail: webmaster@batc.org.uk

Having had my caption for the front cover rejected (Its ATV, but not as we know it Jim) It seems that Mary Shelly and I both created monsters, mine went on to edit CQ-TV. I am however allowed the editorial and I will restrict it to the people we met at IBC.



They say everyone remembers where they were when Kennedy was shot (1963) Martin Salter remembers where he was, putting CQ-TV together, does this ex-editor remember where

he was in 1969, if not I will remind you, you were in Reading teaching among others yours truly videotape engineering. Martin was not the only ex CQ-TV editor to visit the stand, Andy Hughes edited CQ-TV in the early 70's and was taken with the Iconoscope when he visited us.

Mike Cox one time BATC secretary but most remembered for his Cox Box colour synthesiser also visited the stand along with Michael Cosgrove (ex Pye Cameras) and Charlie Rhodes of Tektronix fame. Charlie admitted to owning an Iconoscope tube and wanting to get pictures from it. He took Paul's email address, I am sure that will not be the last we hear from him.

Richard Russell (remember the Electronic Testcard in the Blue ATV handbook) also came along to the stand. I remember him proposing that project over the phone to me. Bill Vinten of guess where, along with Peter Owen of Quantel also visited the stand, by now I wish we had started a visitor's book. There were also those from further afield including Australia, lead by Bruce Robertson of Channel 9, one of his team wanted to pull the MKIII to bits and give it a full service on the spot. As it turned out keeping the covers on equipment and engineers away from the high voltages was quite a problem.

I would like to say thank you to Paul Marshall for all the hundreds of hour's work he put into making IBC come off. I would also like to thank my wife Pauline and Paul's wife Jill for their hard work running the CQ-TV part of the stand and signing up both old and new members..

TREVOR BROWN, BATC Chairman.

By Trevor Brown and Paul Marshall

For those of you that have never visited IBC, visualise if you can a broadcast Television hardware exhibition that would require walking some 10 to 14 miles to visit every stand. The hardware is aimed at broadcasters and as such reflects broadcast prices with a typical TV camera costing anything from £10,000 upwards. The exhibition is not only television camera's, but every piece of hardware that you would require to set up a broadcast TV station. Cameras, VTR machines, Telecine machines, editor controllers, and picture manipulators of all shapes and sizes, not forgetting microwave links for both terrestrial and satellite links.

For the B.A.T.C to be asked to put on a stand at such an event was to say the least an exciting opportunity. The request was for a working display of vintage Television equipment. This role had previously been filled by the National Museum of Photography, Film and Television (Bradford) but this year due to a major rebuild and expansion programme of their Bradford base they were unable to attend. Where do you go to find period television equipment? Where else but Paul Marshall's barn. Paul does own up to owning 42 television cameras all at least 10 years old many over 30. Not content with merely removing the dust from some of this equipment and lugging them to Amsterdam Paul set about recreating what appears to be an extinct television camera, the Image Iconoscope. This was only possible because the N.M.P.F.T. made an Iconoscope tube available to him. Paul then spent some 300 hours researching, designing and building a replica camera just for the show using an original 1940's tube and modern state of the art electronics.

The stand also required a set to point all this electronic hardware at, which also reflected the period. This was a Telstar and Sputnik satellite with the earth in the background, and a rather elegant set of flashing stars. Having built the set, the Iconoscope camera, overhauled the Marconi MKIII and MKIV cameras, constructed a monitor rack and found and tested 4 matching monitors, all that remained was to assemble the stand in Paul's barn, build a scaffold lighting rig, make all the necessary leads up. When this mammoth task was finished the assembly needed disassembling and packing into a van for transportation to Holland, in all about one ton of equipment. This was a tight fit in the van because it was also necessary to take a considerable amount of publication stock as the purpose of the trip was to publicise the BATC and recruit more members. This loading process was reversed in Amsterdam and the ton of equipment was unloaded and hauled into place re-assembled and powered up.

I.B.C Review

The Iconoscope camera turned out to be the star of the show with rumours of its existence spreading through all the numerous halls, with people turning up to confirm the rumours and reminisce over the days of Iconoscope cameras. The pictures our camera produced were pleasing with none of the vidicon stick that so many moved the camera to check. Yes we have no black level was another comment, as hands were put over the lens to prove it went to grey not black. Our pictures were also complete with a strange white patch in the centre of the picture, EEV told us to expect this in a tube of such vintage. Its caused by helium migrating into the tube in very small amounts, but over 50 years the amount becomes significant and causes the white patch.

To complete this display of period television Grant Dixon brought along his 30 line television equipment, this reflected Television in the 1930,s the Iconoscope reflected television in the 1940,s and the Marconi MkIII1 and MKIV cameras extend the display through the 50's and into the 60's. The stand generated a lot of interest in the club and was an appearance at a major international television exhibition, I would like to thank all the people who donated time and effort and without them this event would not have been possible.

Rob Atkinson	Iconoscope tube mountings.
Bernard Golland	Stand and Iconoscope assistance
Lucy Howett	Transport
Mark Clegg	Set design and construction
Richard Harris	Lighting and power distribution
Trevor Brown	Assistant Stand Management
Pauline Brown	Stand duty and patience
Paul Marshall	Iconoscope and general stand management
Jill Marshall	Stand duty and patience
Brian Summers	Administration
Dicky and Margaret Howett	Set ideas
Dave Mann	Donation of a spare tube
John Trenouth	Spares and moral support
Jan Melis	Set electronics
Bob Robson	Iconoscope video amps
Andrew Emmerson	Publicity
Bob Platts	Scaffolding
Ray Hills	Original invitation and much valued support
Jorge Nellis	Monitor maintenance
Grant Dixon	30-line television display
EEV	General finance and technical expertise
SEOS Displays	Donation of PCB's for the Iconoscope
NMPFT	Display boards
Panasonic	Display counters

Rotator Zebedee

By John Stockley, G8MNY

Having used a spiral of low loss LDF450 coax around my rotator for many years on 70 and 23cms, I employed it another amateurs QTH after testing the loss of alternatives on a very weak signal from GB3HV.

Testing at G6ZHC's

Barry QTH is in Cholsey near Wallingford the other side of the 260m Stokenchurch hill and GB3HV at 26km is only just there at P1 occasionally with the aerial at 10M. Various heights and several aerials have been tried. The signal did not improve much as the aerial was raised as high as 19M, as QTH is several km from any local obstructions other than a few trees. The best aerial tested was a home made long 55 element loop yagi made by G3MPS (similar to a G3JVL design). Originally he used a 3m length of UR67 coax from the aerial to past the rotator and then connected to 10m of 1/2" Cellflex to the shack. The UR67 was flexible enough but even a short length from the aerial to past the rotator with connectors is quite

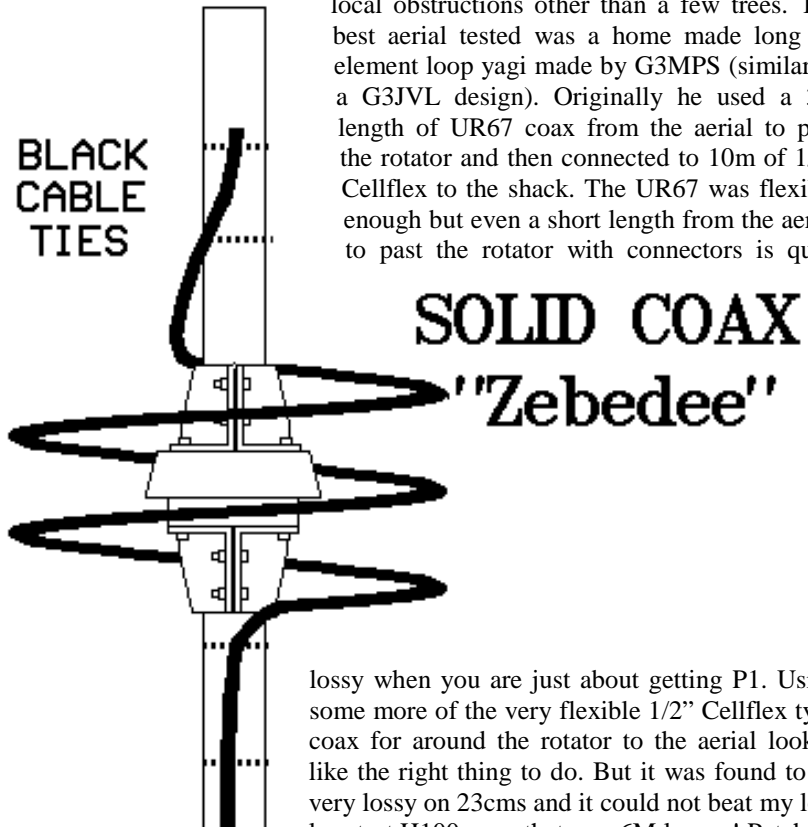

lossy when you are just about getting P1. Using some more of the very flexible 1/2" Cellflex type coax for around the rotator to the aerial looked like the right thing to do. But it was found to be very lossy on 23cms and it could not beat my low loss test H100 coax that was 6M longer! Patching either piece of Cellflex out with H100 or WF103

Rotator Zebedee

improved the picture.

So another day was spent testing with a single 14m piece of LDF450 straight from the aerial to the Rx. At last success, P1-2, peaking to P4 with a good preamp and aircraft.

Using Solid Coax

Using just a small loop of solid coax around the rotator will stall the rotator or worse still tear the outer solid conductor of the coax. The solid coax behaves like copper pipe and can not be twisted at all. However if you use 3 or more turns 1/2m dia of the coax, the coax will offer little resistance, should withstand the rotary strain for many years without fatigue fractures of the coax. The additional loss of the extra length needed easily beats the loss of the alternative shorter flexible coax and connectors.

Although solid coax is generally unfriendly long lengths are surprisingly flexible and are easy to use. Using the right plugs is important but expensive.

I have found some of the very large UR67 type plugs can be made to fit and provide good match if care is taken to ensure the impedance (diameter ratios) are maintained.



The BATC stand at the recent IBC

A Common Date/Time Standard for Amateur Radio:

By Ian Galpin, G1SMD, QTHR.

We have all experienced, at one time or another, the confusion caused by dates written in many different styles by people all around the world. This is usually caused by American computer programs that display dates in the form '12/31/99', and QSL cards for a contact on '7/6/92', the contact eventually being found in your own log-book on the '6/7/92' page, and so on. This problem has been on-going for several hundred years, and the coming Year 2000 seems a good time to solve this one once and for all.

Dates after the year 2000 are already causing problems to some computer programs, especially if the date is stored using only a 2-digit year. In the next century, dates like '03/02/01' will also cause lots of problems to humans, they will often be misread. The example date, above, means '3rd February' in Britain and 'March 2nd' in America. The year may be '1901' or '2001'. Writing '03/02/2001' addresses the second problem, but not the first.

As part of the work to make computer programs 'Year 2000 proof', many people are changing the date format used in the program to be the 'full' format as defined in International Standard ISO 8601 (British Standard BS EN 28601). This standard has been around for over 25 years, and mimics the date format that astronomers have used for over 200 years. Changing to this format solves all of these date related problems in one go.

Astronomers often pass data around the world, and realised long before computers were invented that it would be beneficial for everyone to work to a common format for date and time.

Amateur Radio too, could benefit from this way of working. We already work to a common Time Zone (UTC). The proposal, described here, takes this one step further. Much of amateur radio has already been standardised - callsign allocations, bandplans, transmission modes, Q-codes, CW abbreviations - this is just another area to fall under the spotlight.

The 'full' ISO standard requires that dates are simply written using all four digits for the year, use the order Year-Month-Day, and have a leading zero for month and day numbers between 01 and 09. That is, today's date (September 11th) is written '1997-09-11'. The hyphen separator '-' is normally used between elements. The oblique '/' has another meaning within the standard and should not be used in dates.

Although not covered by the present version of the Standard, many people write the month using the 3-letter English abbreviation, whilst still

A Common Date/Time Standard for Amateur Radio:

retaining the required Year-Month-Day order. So an ambiguous '09/08/97' is replaced by either '1997-08-09' or '1997-Aug-09'. Some astronomers write the month in full in written correspondence: '1997-August-09' and this is also perfectly acceptable.

In this way, '2001-02-03' always means '2001 February 3rd', and cannot be confused with '03/02/01' or '03/02/2001', both of these having more than one interpretation depending on which country you are in.

The ISO 8601 Standard also covers the representation of times, but merely defines the '24-hour' system (the one that we are all already used to) as the one to use. The colon ':' separator is used between elements, and times are written in the order 'Hours: Minutes: Seconds'.

Where dates and times are combined, the date should always be written before the time. For storage of dates and times the separators can be stripped out. So '1999-12-31' can be stored as '19991231'; and '23:59:59' can be stored as '235959' - using a string, packed-BCD, a binary number or whatever you choose.

There is a document currently circulating around RSGB, ARRL, and IARU (and available on Internet for all to read) that proposes to adopt the ISO 8601 date and time standard (and the variants discussed above) for all facets of the Amateur Radio hobby: computer programs, log books, QSL cards, contests, satellite predictions, magazines, e-mail, packet messages, written text, award certificates, Web Pages - in fact anywhere that dates are used.

The proposal also covers the representation of Time Zones, by allowing the letters 'UT' and 'UTC' to be used as well as the letter 'Z' as defined by ISO 8601. For other time zones, ISO 8601 differs greatly from existing practise, and here the Amateur Radio proposal document allows for both methods to be used.

ISO 8601 writes a time zone that is 5 hours behind UTC as '-0500', whereas the zone is more commonly known as 'EST' (Eastern Standard Time). But, it is noted that amateur radio, like astronomy, usually uses UTC as the standard and rarely works in 'Local Time'.

There are other things mentioned in the ISO 8601 standard, which are not especially relevant to Amateur Radio, and so have not been included in the proposal document.

Further information about the proposal, and on other ISO 8601 and Year 2000 issues, can be obtained from many places. Some of these are listed below. The QST article also points to many Internet Web Pages for further reference.

A Common Date/Time Standard for Amateur Radio:

G3RZV, G6CGQ, GM4ANB, DL4EBY, DL8LAQ, G3XWH, G3RUH, G4NJH, HB9MAO, AA7BQ, N3EQF, KP2BL, W1UD, WN4AZY, W3IS and many others support the proposal.

Magazines:

1. DUBUS, 1996-Q4, Page 78.
2. DUBUS, 1997-Q1, Page 83 to 85.
3. Byte, 1997-Jul, Page 89 to 96.
4. QST (ARRL), 1997-Aug, Page 69 and 70.
5. Communications of the ACM, 1997-May, Page 26 to 30 and Page 111 to 117.
6. The Software Practitioner, 1997-May/Jun, Page 1 to 5.
7. Datamation (US), 1996-Jan-01 and 1997-Jan issues (various articles).

Internet:

<<http://ourworld.compuserve.com/homepages/dstrange/y2k.htm>>

<<http://www.aegis1.demon.co.uk/y2k.htm>>

<http://www.kirsta.demon.co.uk/iso_8601.htm>

References

1. IBM Publication GC28-1251-xx, Year 2000 Guide (xx=edition number)
2. Standards: ISO 8601, EN 28601, BS EN 28601, ANSI X3.30, DIN 5008.

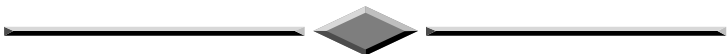

We were hoping to have an article on the Iconoscope camera built by the BATC for the IBC exhibition, but due to the closeness of the publishing date for this issue, it has had to be held over till a future edition. We have managed to include a review of IBC on the following page and some pictures of the event on the inside front and rear of the cover. ED

GB3XT Kits and Bits.

<p>GUNNMOD2 3cms ATV. TX. Kit. Very popular full feature Gunn diode TX. Complete with pre-tuned oscillator head. £30.00. PCB. kit less oscillator £20.00</p> 	<p>TVRO3 ATV Tuneable IF/RX. kit. Fully featured 750-1700MHz input. 12vDC operation. No setting up or alignment required. £50.00</p> 	<p>24cms HIGH GAIN LOW NOISE GASFET PRE-AMP kit. 40db gain 1db NF. with band pass helical filtering. 12-18vDC via coax. £60.00</p> 
<p>24cms ATV TX. kit. Full spec 5ch max. 2W o/p. Filters for video and audio. 12vDC. £125.00</p> <p>Discontinued!</p>	<p>3cms LNB's. Brand new circular input. Fit 38-40mm mounting. Will mount directly on most offset satellite dishes. 0.8db NF. 9.0GHz LO. £40.00</p> 	<p>DTMF DECODER kit. Very high quality decoder IC. All o/p's buffered. Will directly drive TTL/CMOS or relays directly. Can be used to control whatever your imagination thinks of. £12.00</p>

All kits contain all board-mounted components and full comprehensive instructions.

Prices are all inclusive of PandP etc. PCB's are available assembled and tested at extra charge. SAE. (To take A4 paper) for further details.

Orders etc. to

Bob Platts G8OZP, 220 Rolleston Road, Burton Upon Trent, Staffs, DE13 0AY.
Phone 01283 531443, 7-9pm on weekdays only please.

The Nature of Video, part 1

By Henry Ruh KB9FO

Because our world has become largely plug and play, we tend not to think about the WHY of things. This is as true of video as many other areas of technology. The modulation and demodulation processes for video are different to other modulation modes. Even though it is a simple AM modulation, there are considerations that apply to video that do not apply to other forms of amplitude modulation. In addition, there are special concerns when using FM modulation and even digital modulation to transmit video.

If video were symmetrical and sinusoidal, as audio is, there would be much less to concern ourselves with, but video is not symmetrical, and it consists of not only sine wave but square and triangle wave components. While Fourier analysis of the waveform can convert all the signals to combinations of sine waves, we don't transmit Fourier transforms - we transmit video.

When we deal with video signals, we need to concern ourselves with the following items, which I will explain individually after the list.

1. Termination
2. Constant sync amplitude/video gain control
3. DC clamping
4. AC and DC voltages
5. VSWR
6. Subcarrier frequencies
7. Intermodulation
8. Subcarrier injection levels
9. Sync tip clamping
10. Peak white and peak black levels
11. Sync buzz, video frequency response
12. Harmonic and spurious signal generation
13. Reception/demodulation
14. Power bandwidth

15. Pre-emphasis/de-emphasis
16. Audio deviation limiting

Termination

Even before we even consider modulation, we have to consider the video signal level. All video equipment is designed to provide a 1 volt signal P-P when terminated into a 75 ohm resistor. An unterminated (open) video output will often show 2 volts peak to peak, which is then 1 volt when terminated in a 75 ohm resistor. If the termination is precisely 75 ohms, we will have a proper video signal which consists of video, blanking and sync.

If the termination is not 75 ohms, then your signal level will not be the 1 volt expected. It will be more or less, depending on the ratio of the termination value compared to 75 ohms. The use of an 82 ohm resistor will cause the voltage to be wrong by nearly 10%. If you connect a camera to a monitor, then take the “loop through” output of the monitor to a transmitter, the signal should be terminated at the transmitter in the proper 75 ohm resistor. If the monitor has a termination resistor, as most do, you need to turn it off. If you don't, you have two 75 ohm resistors in parallel, or 37.5 ohms termination and the signal level would be LESS than the 1 volt desired. This would make the picture very dark and the contrast level low. You would now begin a game of catch 22 as you turn the brightness and contrast levels up to compensate, then turn the video gain of the transmitter up, never knowing where the correct settings really are.

Do not build or use a transmitter that does not have the proper input termination impedance (75 ohm resistor). If your monitor is designed for 75 ohm operation (as most are) and your transmitter has a value other than 75 ohms, you will never see the actual proper picture brightness and contrast. In other words, what looks good to you, will not look good to those receiving your signal!

The input should also be AC coupled. Today many cameras have a DC voltage present at the output. This DC voltage will cause havoc in a direct coupled amplifier used as a modulator, since it is effectively an additional bias signal, causing the following stages to operate at the wrong bias point, thus compressing the sync or video.

Depth of Modulation

aka constant sync level.

What we see on the picture tube is the video portion of the signal. What we do not see is the blanking and sync portions of the signal. When TV was being invented, thought was given to how to make the picture stable

and how to deal with natural and man made noise. The most troublesome type of noise is impulse noise since it is normally regular in occurrence (occurs at a steady frequency) and is well above the normal background or Gaussian (white) noise present in all electrical circuits. White noise is what you see on weak distant signals commonly called snow, or you hear from the speaker of any radio as the rushing sound. It was recognised that the stability of the picture was the most important part of the signal, so the system was designed to have maximum power during the synchronising pulse times. This made that part of the signal the strongest and most likely to be received even under noisy conditions. At the same time, it was recognised that if a noise pulse was going to be seen as white dots, they could easily overload the CRT electron beam, causing a tiny dot to bloom out and appear as a bigger dot, obscuring more of the picture. So with the signal inverted, white being minimum signal and black being maximum picture power, strong noise pulses appear as black dots or holes, and making them self extinguishing. They are in effect stronger than the blanking level of the signal and the amplitude is then not important. Since the video information is always less than maximum power, we call this negative modulation. On a watt meter, a transmitter with no video or sync will show maximum power, say 10 watts. Adding sync, produces a signal which is only at maximum power for a short time, and at less than maximum power the remainder of the time, so the watt meter now will read about 6 watts. If we now add video, the average level of the video (between black and white) is even less power, so your watt meter may now read only 3 or 4 watts. An all white picture would show about 1.3 watts on your watt meter (an average reading device) even though your transmitter is still putting out 10 watts during the sync pulses. In other words, the brighter the scene being transmitted, the less your average power level.

While a video level control can be added by simply adding a shunt or series variable resistor to the video input, this is not a proper design. Keep in mind that we want a constant ratio of sync to video levels (7/10 of the signal is video, 3/10 is sync). In television we measure this as 140 units with 40 units being sync to blanking, and 100 units being blanking to white. In addition, we allow 20 more units between zero carrier and white so there is always some signal present at the receiver. Thus in a transmitted signal, we measure 160 units from maximum power (sync) to zero carrier). This is called the proper depth of modulation, roughly 26 dB. Video is never 100% modulated.

If we vary the entire sync/video signal up/down from 1 volt, while the ratio may stay the same, the amplitude of the sync to blanking level will change. But the receiver wants to look for a constant sync level so it can easily decode the sync pulses to make a stable picture.

In order to do this, we need to have a means of turning only the video portion of the signal up/down, while maintaining constant sync (power) level. To do this, a diode is used to clamp (hold) the voltage at maximum during the sync, and a level control is then used to vary only the video portion from the set voltage (0.3 volts typically) used for the blanking level. Now you can turn the video level to zero (fade to black) while still transmitting constant amplitude sync pulses. The receiver will remain locked no matter what you do to the video. If the transmitter does not have sync clamping and video only level control do not buy/build it, as you will be very disappointed, and so will your viewers!

If you have an add on amplifier to boost your RF level, it is not likely to be linear. As a result, you will need to be able to adjust the sync and blanking levels to compensate for the RF compression of the following amplifiers. If these are not present, don't bother to build or buy the transmitter!

DC Clamping

Because the video signal is not symmetrical, the average voltage of the AC portion is not zero, but a value which represents the average picture level. The value will be at one extreme when sending a white picture, and at the other extreme when sending an all black signal. As the picture tube (and your transmitter circuits) have a "grid bias" voltage which is set by the blanking level, the DC value of the video is added or subtracted from this blanking DC level. If the value is low, the picture will become too dark and portions will not be visible. If the value is high, the picture will "bloom" and wash out, in some cases we could see the retrace lines on the TV set before DC restoration became the norm. It is important to retain this DC component of the video, and in fact the reason we cannot send video as SSB, but have to retain a portion of the lower sideband (thus a vestige of the sideband...vestigial transmission) is to retain the DC level information. In the transmitter this is set by a bias control, which sets the operating point for the blanking level of the video signal. This is not much more than another diode and resistor which set the bias, or operating point voltage of an amplifier stage, so there is constant blanking level. By now you must realise that there are two fixed voltage points in the modulation circuit, the sync pulse and the blanking level in order to maintain these important parameters of the video signal.

There is also a third voltage point that you do not want to exceed. This is usually set with a fixed resistor. Because you never want to have zero carrier level, you want to maintain at least a 10% carrier level, it is important to limit how high the white video levels can modulate the signal towards zero carrier. By limiting the modulator to 90% modulation, easily by holding the actual modulator voltage to a value slightly less than the

actual final RF voltage, it prevents the carrier from reaching zero. This prevents sync buzz in the audio. (We call it sync buzz even though it is caused by the white portion of the signal. We should call it over modulation buzz to be precise.)

AC/DC Voltages

Because of the set voltages to achieve proper video modulation levels, it is also important to have a regulated DC supply, and minimal AC ripple. Generally the use of a filtered but not regulated supply will not work well because the DC voltage is not stable enough and the supply will be modulated by the video waveform. Remember the RF amplifier is operating from near zero to maximum output. This variation occurs 15,734 times per second. The video also has waveform information up to 5 MHz in frequency, and if you are using an electronic character generator, you could have rise times exceeding 10 MHz. The low frequency AC power line ripple in an unregulated supply need be only 10 millivolts for an easily seen hum bar in your picture. This is a slowly moving dark/light band that appears to travel up the screen. A simple 3 leg voltage regulator type circuit, or pass transistor type regulator circuit will remove the hum from your picture. There also needs to be medium and high frequency bypass capacitors to keep the video modulation off of the power supply line. This is typically a large and small value capacitor (i.e. 0.1 μ F and 47 pF) in addition to the electrolytic filter capacitors on the output side of the regulator (Fig 5). Be sure to use a large gauge wire so the DC resistance of the power lead is low.

Most RF power amplifiers also require additional by pass capacitors in order to handle video modulation without blowing up a few capacitors on the power line!

VSWR

Not only does this apply to RF and coax, but also to video. A high VSWR in either the antenna or the video input cables will result in a loss of picture fidelity. Typically you will see ringing (or ghosts) or smearing (loss of "focus") in the picture. While inexpensive cable can be used, the use of 75 ohm video cable for video connections is preferred. Likewise check the VSWR of your antenna across all of your operating frequencies to make sure you do not have a severe gain loss or VSWR problem which would reduce your video frequency response.

Subcarrier Frequencies

When we transmit video, we also send along a couple of other signals: Colour and sound. The frequencies of these additional signals were

carefully chosen to produce the least amount of interference to the video. In equipment we generally use today, we need not worry about the colour frequency being correct because it is common to use one oscillator which generates the colour and sync frequencies. In our transmitter, however, we need to maintain the proper sound carrier frequency. First, because the receiver compares the audio carrier with the video carrier to demodulate the FM sound, and it is tuned for 4.5 MHz, we want our transmitter to be sending a 4.5 MHz sound carrier. Second, because we use 25 kHz deviation, we don't want to be far off frequency or the sound will be distorted. Lastly, most receivers have circuits which notch the video at 4.5 MHz, and if we are off frequency, the sound trap will not remove the audio from the video and it will be seen as a audio disturbance (squiggles) in the video!

For this reason a stable oscillator circuit is needed. While PLL or crystal control is not required, it is generally better than a simple L/C tuned circuit.

Intermodulation

This occurs whenever there is a non linear amplification of the signal. This can be from a filter response, or by mix products generated in an amplifier device. While there is little in the basic design you can change to make this better yourself, the design should present few places where intermodulation can occur. Because the three signals (video, sound and colour) are modulated and amplified usually by the same final RF device(s) careful attention to the signal levels of these signals needs to be accomplished, and a means of adjusting the injection levels in order to minimise the IM products. The most common is called triple beat. This is a 928 kHz signal which occurs when the colour and sound carriers mix in bad proportion to the video carrier, causing the 928 kHz signal to appear in the video as a diagonal series of lines (herringbone).

Subcarrier Injection Levels

Because we use common amplification, it is easy to generate undesired IM products and also buzz or noise in the audio and video. If you recall, earlier I stated we never want zero carrier. For that reason we hold the white level to a minimum of 10% carrier (or 12%) level. When the audio subcarrier is added to the video carrier, the amplitude of the FM carrier is riding on top of the video waveform. Therefore, we need some amount of power for the audio. The typical level of ham audio is 15 dB below the video carrier, written as -15dBc. If separate audio and video RF amplifiers are used, a full -10dBc (100 watts video, 10 watts audio for example) can be used. (Broadcasters can use up to -7 dBc audio carrier levels.)

By holding the peak white to 10-12% power, and the sync to 90% power, we have 10% at each extreme for the FM sound carrier. The sound can now be received and demodulated without noise from the video. If the sound carrier is compressed (reduced) during either the sync or white periods, we have amplitude modulated the FM carrier, which will show as “incidental AM modulation noise” a fancy way of saying buzz.

The subcarrier level can be set by the manufacturer or can be adjustable to compensate for the use of external amplifiers.

SYNC Buzz

Although I have already covered the primary source of buzz in the audio caused by the video modulation, there is another source of this symptom. The NTSC television system specifies an RF bandwidth of 6 MHz. Within this we can safely modulate up to 4 MHz with video information. The resolution of a picture is determined by the number of TV lines the image can display. For example, a camera can be said to have 250, 400 or more lines of resolution. What it is referring to is the horizontal resolution, since the number of scan lines (vertical resolution) is fixed by the scanning system at 525 per frame, or 262.5 per field since the picture is made from the interlace of two fields per full picture, 60 fields, 30 frames per second. (Actually 29.94 to be precise). With a camera, the higher the resolution the better since it means a sharper image and more detail. Many professional cameras today have 850 or more lines of resolution. A TV line is considered as the black line, or the white space between lines. So a system with 800 lines could actually capture and display 400 alternating black and 400 white “lines.” The number of lines of resolution converts to frequency at the rate of 80/MHz. So a 5 MHz video bandwidth equates to 400 lines of resolution. The topic of resolution could be a book in itself, covering the actual frequency response, aspect ratio, depth of modulation and aperture effects.

Electronic generation of a video signal is different to the optical generation since any optical system must divide the image into pixels, picture elements, the size of which is determined by the number of CCD sensors or the size of the electron beam spot on a vidicon tube. Because of the finite size of the physical device pixel, certain effects occur. For example, as the image detail increases, the ability to generate a complete transition from black to white decreases. Eventually the detail is too small to be discernible and the picture becomes a grey flat field. The detail can no longer be represented by black/white transitions. This is the cut off frequency or limit of resolution of the pick-up device. Long before this happens, the image will generate an alias. An alias is a false edge, or edges. If the edge of the object is not in perfect alignment with the scanning direction, there is a diagonal line to the image. On successive

scans of adjacent lines, the image will first be in a position where it is seen by a whole pixel, then less and less, then none, then more and more until it is seen by the adjacent pixel.

The electronic generation of a signal, such as in a character generator (title making device) is limited only by the electronic rise time (volts per second) of the components. Thus it is quite possible to generate a signal which has a rise time of equal to a sine wave of 10, 15 or more MHz. Some cheap units have energy to over 100 MHz! Since these frequencies are outside of the bandwidth of the receiver, they represent segments in time when the signal cannot be fully demodulated. This causes the audio demodulator to have nothing to work with, and generates a buzz from the "holes." This is a simple way to explain the problem without getting into Nyquist filter response for the mathematically minded.

The problem is easily solved by using a video low pass filter which limits the video to signals of 4.5 MHz or less. Since your receiver cannot discern a higher value than its IF bandwidth can pass, there is no loss in picture quality. Most home TV sets cannot demodulate video more than 2.5 MHz because of the methods used to separate the colour from the luminance information. This is also why a computer screen in a high resolution mode, always looks sharper than a TV screen. The computer image is not being transmitted, and does not have a bandwidth limitation from RF channel width, but it is also why your computer can generate interference from its higher scan and video and data signals! A properly designed TV transmitter has a video low pass filter built in. If it doesn't don't use it or buy it.

The video filter also helps protect other spectrum users from unnecessary sideband splatter caused by computer graphics or title generators, since anything outside of the receiver bandpass is just wasted energy and QRM for others.

Harmonics and Spurious Signals

Modern transmitter design minimises the generation and radiation of spurious signals and harmonics. There is no need nor any desire to transmit more than the information we want to transmit, and it should be contained within the bandwidth of the mode, regardless of whether it is FM, packet, SSB or video. Modern transmitters can eliminate these problems by design. Two common methods are to start at a low frequency, and then convert to the operating frequency, (heterodyne process) or direct frequency synthesis, with the master RF oscillator operating directly at the operating frequency. The use of multiple frequency multiplier stages is no longer necessary or desired as they can be the source of spurious

signals and harmonics and directly radiated interference if they are not designed properly. .

There are a large number of IC oscillators which will operate directly in the frequency range desired, for UHF and SHF operation to 2.5 GHz and beyond. This also reduces the parts count/cost of a project, since the frequency multiplier stages and their multitude of parts are replaced by a single IC chip and a handful of frequency determining components and master oscillator. The phase locked loop (PLL) is the most common method of generating direct on-frequency RF signals. The devices allow both easy selection of operating frequency, and ease of modulation for FM mode video as well. With proper selection of loop time constants and output passband filters, the chip can produce a very clean carrier and the harmonics or spurious signals of multiplier stages are eliminated. Noise of the oscillator is a consideration for critical designs, but for our purposes can be ignored. By adding a passband filter and a MMIC (brick amplifier) the output of the PLL can be increased to the operating power desired.

The other method generates the TV signal at a low frequency, typically 45 to 70 MHz, which is then heterodyned (up-converted) to the desired operating frequency. By changing the local oscillator of the converter, frequency agility is achieved to select the frequency desired within the band of choice. This also allows a multi-band transmitter to have but a single common modulated exciter, with operation on 70, 33, 23, 13 cm or higher achieved by using different converters and power amplifiers. This has long been the choice of SSB and CW VHF-UHF-SHF DX'ers, as it offers a clean signal with no harmonics or "birdies" to cause confusion in reception or QRM to other frequency users.

AEA used this technique in their ATV transmitter, and also incorporated a SAW filter to provide vestigial sideband filtering inside the unit. Reduction of the lower sideband can also be achieved by phase cancellation, modulating both the driver and final stages so that the lower sidebands are attenuated, as is done in the PC Electronics designs.

In any case it is good practice to have a VSB filter in the output of your system or otherwise limit the bandwidth of your signal to prevent unnecessary QRM. For a repeater it should be considered mandatory to have a VSB conforming output.

Power-Bandwidth

This applies more to tube amplifiers than solid state. It refers to the ability to not only generate the carrier power desired, but to generate it across the entire bandwidth of the signal. Generating a signal with a few kHz wide sidebands for voice is no trick. ETO/Erhorn make very nice amplifiers and have written about the necessity for peak power in excess of 1500 watts to

prevent distortion of the SSB signal because of instantaneous peak power requirements. The same is true for television signals, except our modulation can have sidebands across 4 or 5 MHz, requiring the generation of power across the entire bandwidth without loss of main carrier or low frequency sideband power (sag). Remember, there is a DC component to the video signal. If the DC component is altered by the power amplifier, the picture brightness and contrast will vary accordingly. In commercial TV, it is not unusual to use a 5 kW amplifier circuit to generate a 1 kW video signal, so that there is adequate reserve for peak power/bandwidth demands.

Lack of bandwidth in a modulated amplifier stage will also affect the video response (resolution) and the ratio of colour and sound subcarriers. In extreme cases found in old tube RF power amp designs, you cannot obtain sufficient bandwidth to transmit colour or sound!

Audio

Pre-Emphasis/ De-Emphasis

Television audio is FM. It is the nature of FM that the audio signal to noise ratio can be improved by boosting the high frequencies in transmit, and reducing them on receive to reduce the overall noise level. TV and FM broadcast receivers have built in de-emphasis circuits. Thus in order to have a flat audio response in your TV system, just as in your FM voice transceiver, you need a pre-emphasis circuit. This consists of a resistor and capacitor to achieve a boost curve of 75 μ Sec. That is the time constant used to achieve the desired response. The audio response is essentially not changed to 400 Hz. The rise begins slowly to 1 kHz, and increases to where it is about 14 dB at 15 kHz. Without an audio pre-emphasis circuit, your audio will sound muddy and be difficult to understand.

Deviation Limiting

Just as with voice transmission, you want to limit the deviation of the FM sound subcarrier for TV. Over deviation simply causes distortion and QRM. Good designs incorporate either a soft limited (two diodes and two resistors) or a compressor circuit (IC) to control the audio levels, help maintain consistent audio level and prevent over deviation. TV receivers require a 25 kHz deviation level for full audio output, so the transmitter should be adjusted to provide 25 kHz peak deviation.

This should be almost everything you need to know to examine a TV transmitter to see if it has the correct technical characteristics for good results and good engineering practice. 73 Henry KB9FO

Worthing & District Video Repeater Group

GB3VR & GB7VRB

1Watt FM-TV 24cms Transmitter

The 1 watt transmitter generates its signal at the wanted frequency which can be set anywhere in the band, colour or B/W. On board intercarrier sound and fixed pre-emphasis are standard features. The kit includes the PCB all the on board components, pre-drilled heat sink, an Eddystone Di-cast box and full and comprehensive instructions. Building time is three evenings work. The new price for this kit is £80.00, P&P £2.50. Over 650 units sold to the Amateur market alone.

This is probably the biggest selling TX kit in the world!!!

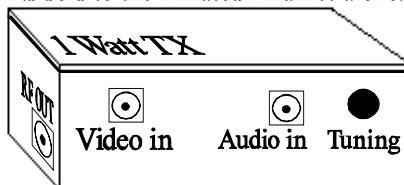

Two channel phased locked loop kit.

This add-on kit vastly improves the overall stability of the 1 watt transmitter. Two crystal locked channels and a third free running tuning position are available. Kit price £30.00

Amiga ATV Program-2

The New Amiga ATV program has more features than ever, up to 56 testcards, 20 wipes, superb text control, 30 screens of text messages, QRA calc, Testcard music, selectable displays, and this version has a DTMF tone pad to control your repeater. All testcards are over-scan i.e. the whole screen is used, Load in your own customised testcards, Extra large text, scrolling text, clock, callsign extensions, Hot key operation, Doc reader, ATV Cli, Cross Hatches, Purity and a comprehensive section for genlock users. For any Amiga with 1meg or more, state callsign and QRA (if known) when ordering, this three disk set is now only £10.00 P&P 75p

Spectrum ATV Program

Still selling after all these years, why, its good, its cheap and it works on all spectrum based machines. The 48k version has over 60 commands which include 7 Testcards, Memo pad, clock, maps, tones, QRA locator, various size printing, plus disk transfer routines and much more. Now only £5.00 P&P 75p

PC ATV is coming.

Orders should be sent to:-

Treasurer of GB3VR, R. Stephens, 21 St. James Ave., Lancing, Sussex, BN15 0NN. Cheques payable to "W&DVRG" Tel (01903) 765760 7 to 8pm.

Update on ATV repeaters

By Graham Shirville, G3VZV

However in case you need some gap fillers, here is an update on ATV repeaters as at 7th September 1997.

Current application with RA is a 23cms unit GB3AD in Stevenage. This has quite limited projected coverage but will fill the valleys surrounding the town. The East Sussex group has found another site for "GB3VX" and they will be filling in the application forms this month.

The SCART group has decided that GB3AT could do with a better site in Hampshire and to that end are also completing the reduced quantity of forms required for a "site change"

Graham Hankins G8EMX in the Midlands is also completing a full application for a 23cms unit in the Birmingham area. It is hoped that this unit can co-exist with the existing units in the area and the Clee Hill radar.

All is quiet otherwise.

73's Graham G3VZV

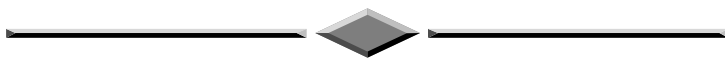

World Wide Web

The BATC web pages have now a permanent home. This is with a commercial web service provider. The URL is:-

<http://www.batc.org.uk>

A feature is a software download area. This page contains programs, data and code from articles in CQ-TV as well as other programs related to amateur television.

TV on the Air

By Graham Hankins G8EMX.

My 'CQ-TV' 179 arrived on August 13, quoting an August 15 deadline so this TVOA is going to be very simple, mostly pictures, few words. I usually fill a 35mm film with ATV photos, so there are loads still unpublished.

Let's start with a visit to Alan Kendall G6WJJ in

Stourbridge. Tuesdays are ATV activity night on 24cm and 70cm - yes, the local 'net' includes 436MHz vision. Alan runs 20W peak sync on 70cm, 23W on 24cm and 10mW on 3cm.

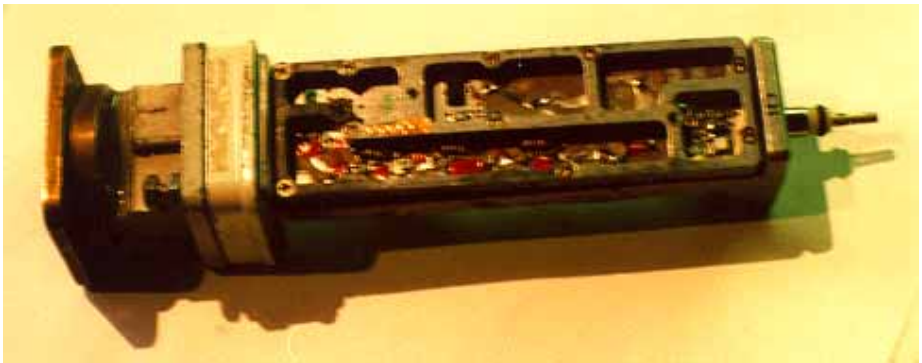

Low Noise Block being converted by G6WJJ to transmit on 10.135GHz, ready for a potential 10GHz ATV repeater in Stourbridge.

Arthur Bevington G5KS, one of BATC's senior members, has a mammoth mast in his back garden with antennas for 70cm and 24cm. Arthur usually

sees the Stoke repeater GB3UD, so was very puzzled because he had not received 'UD for some time. His sons paid him a visit, found a fault in his feeder, so Arthur is back 'in ATV business' again.



Alan Kendall G6WJJ monitors incoming and outgoing video.

5 Arthur Bevington G5KS, one of BATC's senior members, monitoring GB3UD again at P4 from his home QTH near Dudley.

6 Frank G0GSR (Devon) and the hardware to 24cm ATV repeater GB3WV (Dartmoor)

ATV Repeater Group Newsletters.

Please, please send a copy of your newsletter to me for future 'TVOA's. I have had one lately, 'P5' from the Severnside Group, and a posted packet version of their newsletter from the Home Counties ATV Group (I haven't been on packet for quite some time).

In the June 1997 issue of 'P5', Ian Bennet G6TVJ gives a detailed insight into 'The Secret Revolution' undergone by 24cm repeater GB3ZZ. Almost every element of the repeater has been modified and improved;

Receiver - improved video low frequency response; proper 'sample and hold' amplifier; special video equaliser installed; new video switcher; rebuilt caption generator. To list but a few!



Another Alan, Alan Banner G7UMW (West Bromwich), sends a P5 'shack shot' on 70cm to G6WJJ.

Ian comments: "All these mods. are pretty subtle, but if you could remove them all at once I think you would notice quite a difference".

The Severnside ATV Group has a new internet address; it is severnsideTV group@cableinet.com.uk (all lower case except 'TV')

So, Repeater Group newsletter editors, let's be reading your publications, please. Send them to

Graham Hankins G8EMX 11, Cottesbrook Road, Acocks Green, Birmingham, B27 6LE

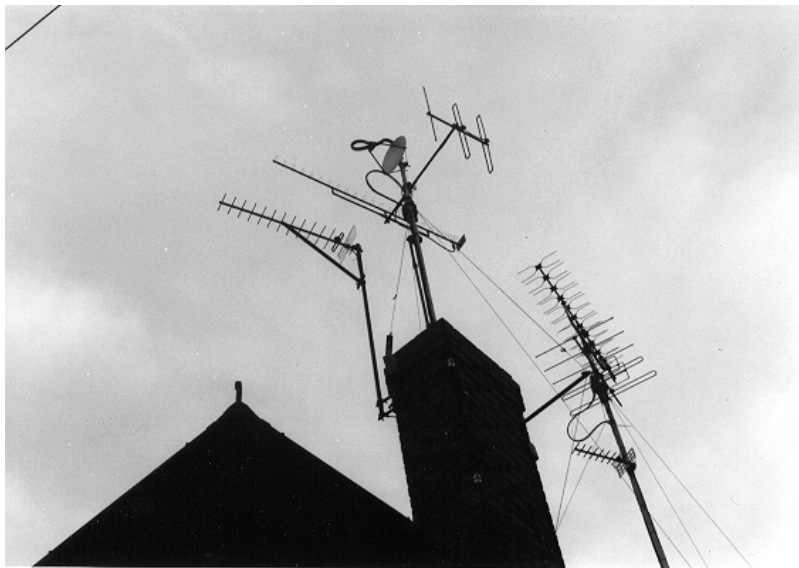

Rooftop antenna 'farm' at QTH of Alan Kendall G6WJJ. Beams for 2M, 70cm and 24cm; dish for 10GHz.



Arthur Bevington G5KS, one of BATC's senior members, monitoring GB3UD again at P4 from his home QTH near Dudley.



Frank G0GSR (Devon) and the hardware to 24cm ATV repeater GB3WV (Dartmoor)

Deadline

Will all contributors please note that the deadline for articles for CQ-TV 181 is December 10th 1997. Please send your contributions in as soon as you can *prior* to this date.

If you would like to contribute an article for publication in CQ-TV, then please send it to the editor, either by post, or preferably by email. If you don't use a word processor, plain ASCII text is fine. Please see page 2 for address details.

The CQ-TV Word 6/7 document template can be downloaded from our web site. Select the CQ-TV magazine link from the home page at <http://www.batc.org.uk>



VHF COMMUNICATIONS

VHF COMMUNICATIONS magazine is published quarterly and is available from **KM Publications**, 5 Ware Orchard, Barby, Nr. Rugby, CV23 8UF, England.

Telephone: 44 (0) 1788 890365, Fax: 44 (0)1788 891883

Email: vhfsubs@g6iqm.demon.co.uk



The 1997 subscription rate is £18.00 for cash or personal cheque (drawn on a UK bank, or bearing the name of a UK banking agent), postal orders or bankers draft made payable to VHF Communications. Payment may also be made by any major credit card at £18.90. The subscription included surface mail charges, airmail is extra at £6.50 per year (£6.85 by credit card). The magazine is a **MUST** for the radio amateur and professional engineer interested in VHF, UHF and Microwave working, containing, as it does, detailed construction articles for equipment operating in these bands.

Back Issues: special offers - enquire for details

Binders to hold 12 issues £5.50

Complete Index 1970 - 1995..... £2.75

Email: vhfsubs@vhfcomm.co.uk Web site: <http://www.vhfcomm.co.uk>
secure credit card page: <https://www.vhfcomm.co.uk/saleform.htm>

GW ATV Demonstration

By John Lawrence GW3JGA

The Dragon Amateur Radio Club, who meet in Menai Bridge, Anglesey, North Wales, were treated, on 16th June 1997, to a demonstration of Amateur TV by members of the GB3TN ATV Repeater Support Group.

David, GW8PBX and Brian, GW4KAZ set up a portable station near to the old Marconi Transmitter site at Waenfawr, near Caernarfon, meanwhile John, GW3JGA and Barry, GW8FEY had prepared receivers and monitors for use in the meeting room at the Four Crosses pub at Menai Bridge. The intention was to provide an O.B. from Caernarfon to Menai Bridge, using a 3cms link over a path distance of about 9 miles. 24cms gear was also available should the 3cms link be inadequate.

The 3cms link was set up by transmitting from near Caernarfon using a gunn unit with a 10dB horn and receiving this on a 60cm dish mounted on a tripod in the car park outside the pub. P5 pictures were received immediately, the horn was then replaced with a PW 'penny feed' dish and after talking-in the beaming of the dish, the 3cms link was as solid as a 'Ty Bach' (brick closet to non-Welsh speakers). However, some problems were experienced with the inter-carrier sound, probably due to strong RF fields at the O.B. site getting into the audio. Talkback from the meeting was initially on 144.750 and this allowed questions to be put to the O.B. team. Derek, GW3FDZ and Bob GW0AYQ, who had travelled up from mid-Wales for the event, joined the group near Caernarfon.

Weather conditions and visibility were excellent and the meeting was treated to slow panning shots of the Welsh coastline ending up with a rare telephoto view of the Wicklow Mountains of Ireland some 80 miles away. Signals from GB3TM, the 24cms repeater on the north east corner of Anglesey, 21 miles away, were being received near Caernarfon at P5 and these were relayed to the meeting. Pictures were then sent from GW3MEO, 38 miles away in Prestatyn via the repeater and relayed to the meeting on 3cms.

As the evening cooled, after a warm day, a lift in conditions took place on 24cms over the sea path between Wales and Ireland. This enabled EI stations located in Dublin, 85 miles away to be received and relayed to the meeting. Albert, EI6AS was P5 at times, with Charlie, EI2EM and Dave, EI2HR peaking P2 - P3. Talkback to EI was conducted on 144.750 and talkback from the meeting then switched to 433.400. Dennis, G3UVR, who travelled from the Wirral to attend the meeting, provided an

GW ATV Demonstration

additional local ATV signal from his mobile 100mW 24cms TX , parked in the pub car park.

All in all, a most interesting demonstration of Fast Scan ATV which, with the associated communication links, covered four amateur bands. The Dragon Amateur Radio Club have invited us to return in June 1998 to do it all again. It seemed far enough away to say 'Yes!'

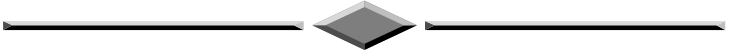

Visit our Web site at www.batc.org.uk
to view or download electronic
versions of recent issues of CQ-TV



Sevenside Television Group

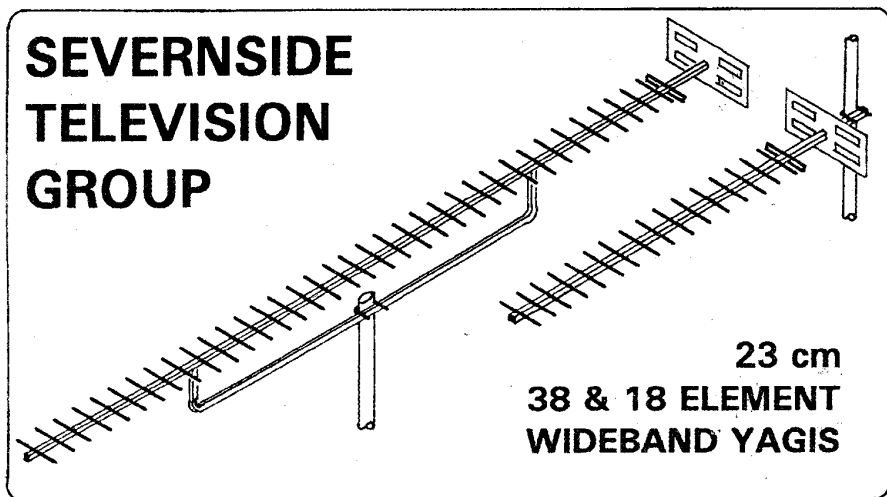

All of our 23 cm Aerials are specifically designed for ATV use - although they can be used for other modes as well. Wideband characteristics mean that you need only one aerial to cover the repeater input and output channels. Our famous wideband yagis come fully assembled in two versions:

38 ELEMENT HIGH GAIN: 14 dB gain, 1.8 m long, **£26.00** plus postage.

18 ELEMENT STANDARD: 10 dB gain, 0.9 m long, **£15.00** plus postage

Don't forget our **20 ELEMENT CONVERSION KIT**, which converts your existing 18-element aerial to the full **38-element** high gain specification: **£13.00** plus postage. Our 23cm **TROUGH REFLECTOR** is quite unique, combining 11dB gain with wide bandwidth *and* wide beamwidth. It's also compact, just 0.55 m high, 0.35 m wide and 0.3 m deep. Supplied as a kit of predrilled and preformed parts for easy "Screwdriver" assembly: **£19.00** plus postage. All aerials feature an SWR of less than 1.5:1 and are supplied with mast clamps suitable for masts up to 55mm diameter. Mast poles shown are not supplied.

POSTAGE: **£3.75** for one aerial, **£5.00** for two or more. Telephone orders with cash on delivery: **£2.75** supplement per order, Orders from outside of the UK - please write for carriage quotation.

CHEQUES payable to "SEVERNSIDE TELEVISION GROUP" and send to 18, Linnet Close, Patchway, Bristol BS12 5RN. Telephone (evenings and weekends only please) 0117 969 8136. Please allow 28 days for delivery.

By Paul Holland G3TZO

The cold dark winter nights are almost upon us - but for once we should not be downhearted! Although this year has continued to see the relentless march towards digital TV in Europe there is still much of interest to serious observers of the Clark Belt. New satellites for Scandinavia, the launches of Hot Birds 3 & 4 and the emergence of even more D2Mac services (despite the obituary for this standard having been written many times) have all served to keep interest alive. Of course, digital TV services come and go but in general proliferate at an amazing pace - so lets get on with the news.....

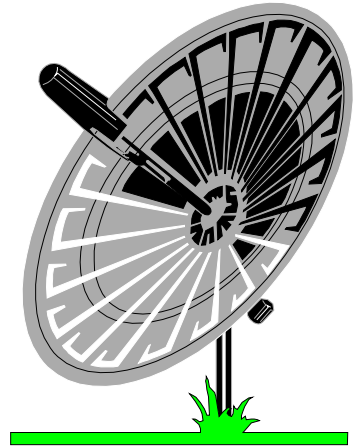

New Channels

As expected, the National Geographic Channel has replaced Sky 2 on Astra 1A Tp 77 11,303 (H) as part of a general reshuffle and rescheduling of Sky Channels on Astra.

The launch of the Swedish business channel TV8 took place in October 15 as a digital only channel on Tele-X. When Sirius 2 is launched and activated (which appears to be December at this point) the digital transmissions will be moved there.

A new Danish channel called DK 4 has begun digital transmissions on Tele-X.

The launch of Telia/SVT's "UK Gold channel" Guldkanalen (the Goldchannel) is reported to be delayed one year. The channel is planned to be distributed digitally both terrestrial and on cable. Probable carriage will be from the Scandinavian Hot Bird slots at either 1.0 Deg W or 5.0 Deg E.

BSkyB's new Sky Box Office pay-per-view service has started on Astra transponder 60, former home of Sky Movies Gold. SBO may also expand to other Astra transponders in due course.

SVT's European channel SVT (4) Europa will be available via satellite sometime in November. To receive SVT 4 Nokia has equipped its new DVB 9600S with a Viaccess CAM-module. A smart card is also necessary (this will cost 200 SEK to buy and 1000 + VAT per year to subscribe).

New Products

For those who have already bought or are contemplating buying the Nokia Mediamaster, otherwise known as the d-box, there are now a number of software packages becoming available which take the pain out of manipulating the various control menus. Illustrated below is a package known as D Remote V1.0 which is a fully programmable d-box remote control programme. D Remote has a number of features including; reproducing all key's of the original remote control, free configurable program list for direct program-selection, configurable buttons, pre-programmed for more than 200 Signals on all Satellites between 42° East and 45° West, Free Data-Updates via Internet-Download, no need to input the PID-Codes and a QPSK-Search-Mode. It is only necessary to set the correct polarisation and frequency of the signal and the remaining parameters are automatically set.

D Remote needs a PC with Windows 95 and works with all d-boxes including those that have been modified.

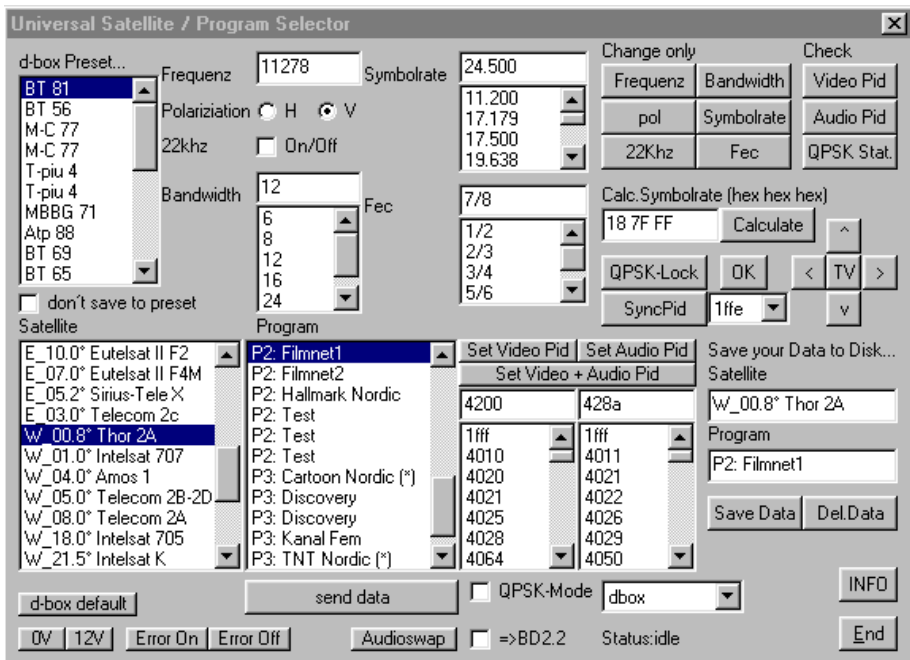

D Remote programme selector Menu

Launch News

Proposed Launch Schedule

This is the latest update on launches planned up until about the middle of next year. As with all launches the actual lift off depends on success or failure of previous launches and dates should always be treated as provisional.

Satellite	Date	Position	Launcher
Sirius 2	December 97	5.0 Deg E	Ariane
Astra 1G	4th Qtr 97	19.0 Deg E	Proton
Nilesat 1	End 97	7.0 Deg W	Ariane
Astra 2A	December 97	28.2 Deg E	Ariane
Intelsat 803	September 97	21.5 Deg W	Ariane
Hot Bird 4	December 97	13.0 Deg E	Ariane
Panamsat 6	4th Qtr 97	43.0 Deg W	Ariane
Intelsat 804	1st Qtr 1998	29.9 Deg W	Ariane
Eutelsat W1	Jan 98	10.0 Deg E	Atlas
Intelsat 806	Mar 98	40.5 Deg W	Atlas
Hotbird 5	Mid 98	13.0 Deg E	Ariane
Thor 3	Aug 98	1.0 Deg W	Delta 2
Hispasat 1C	4th Qtr 98	30.0 Deg W	TBA

Recent Launches

Panamsat 5 - PAS-5 which launched in late Summer is the most powerful satellite built by Hughes to date and features state-of-the-art technologies. The satellite will be used by PanAmSat Corp., primarily for direct-to-home television services in Latin America and other video and telecommunications services for the Americas and Europe. With nearly 10 Kilowatts total spacecraft power generated by two four-panel solar wings, PAS-5 is twice as powerful as other Hughes-built spacecraft now in orbit. PAS-5 carries 24 active 50-watt transponders in C-band and 24 active transponders in Ku-band. Six of those are 60-watt transponders, and 18 offer 110 watts. PAS-5 will operate at 58 degrees West longitude, over the Atlantic Ocean.

The PAS 5 Atlantic Ocean Region footprint is illustrated below;

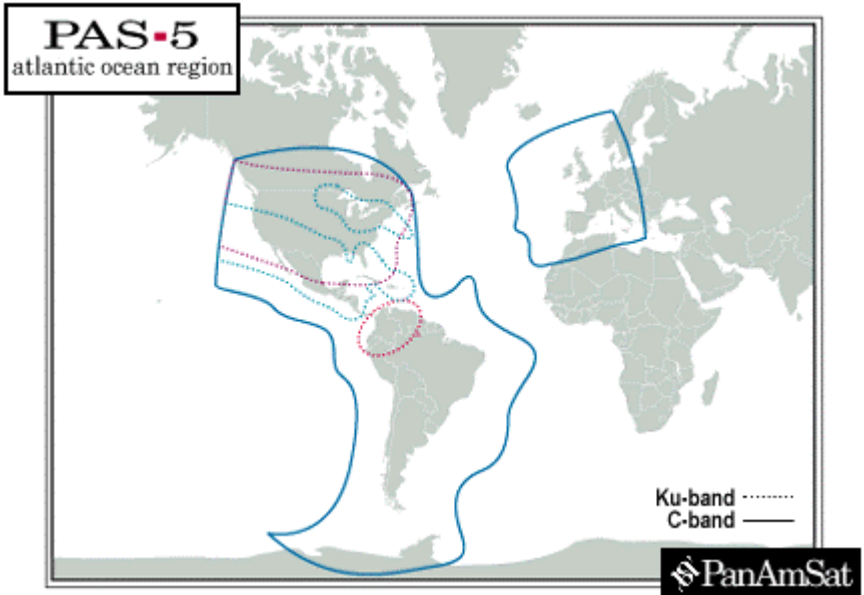

Hotbird 3 - Hotbird 3 launched successfully back in September and adds a further 20 Ku band transponders at the 13.0 Deg E slot. Flight 99 was carried out by an ARIANE 44LP, the version of the European launcher with two solid and two liquid-propellant boosters. Hotbird 3 was built by Matra Marconi Space in Toulouse and is designed for carrying both analogue and digital television. With 53 dBW over most of Europe Hotbird 3 will be receivable with an antenna as small as 45cm. The frequency allocation and footprint for Hotbird 3 is given below;

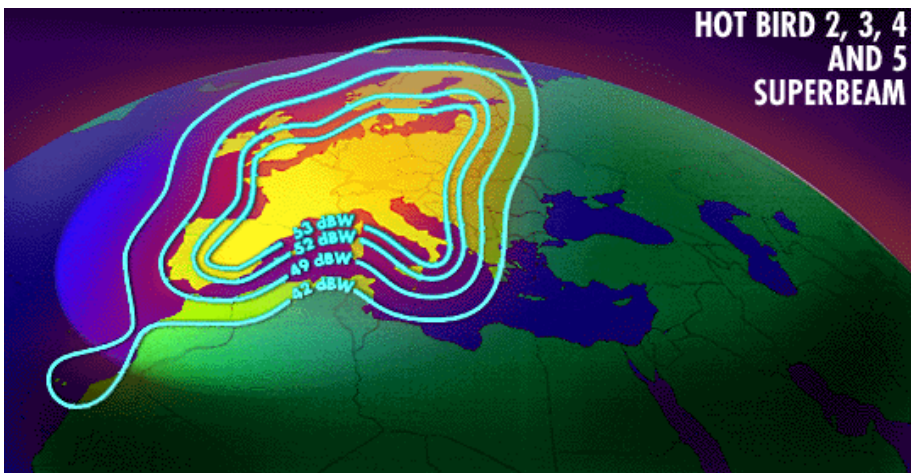

<u>Tp</u>	<u>Freq GHz (V)</u>	<u>Freq GHz (H)</u>
70	12.11108	
71		12.13026
72	12.14944	
73		12.16862
74	12.18780	
75		12.20698
76	12.22616	
77		12.24534
78	12.26452	
79		12.28370
80	12.30288	
81		12.32206
82	12.34124	
83		12.36042
84	12.37960	
85		12.39878
86	12.41796	
87		12.43714
88	12.46591	

Hot Bird 3 Frequency Plan

Upcoming Launches

Eutelsat W1 - Eutelsat’s new generation of satellite is now officially known as the W Series. W1, the first satellite will be launched at the end of this year/early next with W2 and W3 to follow at 1 year intervals. Built by Aerospatiale, the W series will start to be launched from the end of 1997 and will be positioned at 10, 16 and 7 degrees East, in that order. Each one will replace an existing EUTELSAT II satellite and add 50 per cent more capacity, broader coverage and stronger power on the ground. In addition to a fixed Widebeam each of the W series is equipped with two steerable beams which can be oriented to anywhere on the earth visible from their orbital slot. A further satellite in manufacture is SESAT (Siberia Europe SATellite) which will be delivered in orbit to EUTELSAT at the end of next year for positioning at 36 degrees East. Equipped with 18 transponders SESAT has a unique coverage which will permit interconnectivity from western Europe to eastern Siberia. SESAT is being built by the Russian aerospace company NPO-PM together with Alcatel Espace.

Sirius 2 - Sirius 2 was scheduled to launch in December as we closed for press. The latest footprints look optimistic for reception in the UK. The

frequency plan and footprint information for the 32 transponder satellite is given below.

Freq (GHz) V	Freq (GHz) H
11.747	11.727
11.900	11.767
12.092	12.073
12.130	12.111
12.169	12.149
12.207	12.188
12.245	12.226
12.284	12.265
12.322	12.203
12.360	12.341
12.399	12.380
12.437	12.418
12.476	12.456
12.604	12.646
12.687	12.687
	12.729

Sirius 2 Frequency Plan

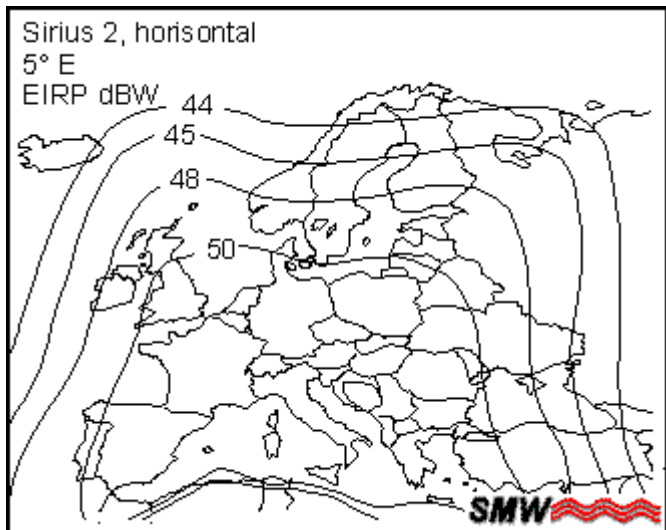

Sirius 2 Vertical Transponders

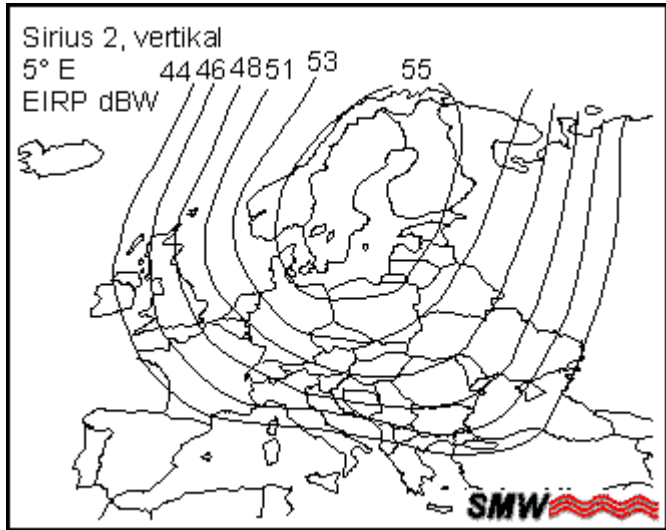

Sirius 2 Horizontal Transponders

TDF2 on the Move

Following a contract signed between EUTELSAT and TDF (part of the France Télécom group), the French TDF2 television satellite has joined EUTELSAT's fleet of satellites. The satellite has been repositioned from 19 degrees West to 36 degrees East to provide capacity for the private Russian television broadcaster NTV which will transmit programmes over European Russia. TDF2 will be joined next year at 36 degrees East by EUTELSAT II-F2 (following launch of Eutelsat W1) and SESAT in order to constitute a key eastern orbital position for EUTELSAT. Operational since mid-1990, TDF2 is expected to remain in service at least until early 1999. The satellite operates in the BSS band (11.7-12.5 GHz) which is reserved for television broadcasts to direct-to-home antennas.

Transponder News

ORION 1 37.5 Deg Witalian channel Cinquestelle has started a digital service on 12.603 GHz (H) (SR 4893, FEC 1/2, V-PID 4456, A-PID 44BB).

15.93 Deg W LUCH 1 MIR feeds can occasionally be seen here on 10.830 GHz.

5.00 Deg W TELECOM 2B The French information-channel called La Chaîne Info closed its analogue service on 12.585 GHz (H) in September. LCI can still be received via the Canal Satellite Numeric digital package which comes on ASTRA 1E Tp 68.

0.98 Deg W INTELSAT 707 NRK1 has left Intelsat 707 and is only available in D-MAC on Thor 2 (see below). The former NRK transponder on Intelsat 707 is now relaying a digital package, which includes TV Finland. This is currently in clear MPEG-2, but it will probably be encoded soon in Conax. The latest analogue transponder allocation is given below;

Tp	Pol	Freq	Service	Mode
-	V	11.001	TNT/Cartoon	D2Mac
61B	H	11.016	TV Norge	PAL
72	V	11.054	TV 1000	D2Mac
61	H	11.096	TV3 Norway	D2Mac
63L	V	11.133	BBC Prime	D2Mac
64L	H	11.485	CNN International	D2Mac
75V	V	11.473	TV3 Denmark	D2Mac
75U	V	11.540	VTV	PAL
65	H	11.555	Norsk TV2	D2Mac
79	V	11.597	TV3 Sweden	D2Mac
69	V	11.667	Sky Entertainment	D2Mac
69B	H	11.679	BBC Prime	D2Mac

0.80 Deg W THOR 2 This satellite is now filling up with many channels moving around between Intelsat 707. This was the latest allocation at close for press.

Tp	Pol	Freq (GHz)	Service	Mode
1	V	11.216	TV Denmark	D2Mac
2	H	11.229	Canal Digital	Digital
3	V	11.247	Telenor	Digital
4	H	11.261	Canal + Denmark	D2Mac
5	V	11.278	Canal Digital	Digital
6	H	11.293	Canal + Norway	D2Mac
7	V	11.309	Promos	Digital
8	H	11.325	NRK2	D2Mac
9	V	11.341	Kanal Femme	PAL
10	H	11.357	NRK1	D2Mac
11	V	11.372		
12	H	11.389	TVS	D2Mac
13	V	11.403	Spare	
14	H	11.421	TV Norge	PAL
15	V	11.434	MTV Europe	D2Mac

0. 2 Deg W TV Sat 1 The History Channel is now sharing with TV1000 Cinema on 11.888 GHz (LHC). European Business News is sharing time with the Sci Fi Channel on 11.912 GHz (LHC).

5.14 Deg E SIRIUS 1 The Playboy Channel is now on 12.015 GHz (RHC) from 0.00 - 4.00 CET daily. TVG and TV6 Sweden can be found on the same frequency between 04.00 - 0.00 CET.

13.00 Deg E HOTBIRD 1, 2 & 3 Russia's VRT ("World Russian Channel") has started on Hot Bird 1, on 11.304 GHz in clear MPEG-2.

The newly launched HotBird 3 will carry both analogue and digital channels in a very similar method to HotBird 2. Hungary's second national television channel MTV2 should have launched by now on widebeam-transponder 71, 12.130 GHz (H), PAL clear with sound on 6.60 MHz (mono), 7.02/7.20 MHz (stereo), bilingual programmes: original 7.20 MHz, translation 7.02 Mhz.. Also rumoured for carriage on HotBird 3 are ERT, the Greek satellite entertainment channel, TV Polonia, and a Swiss digital package. No English language channels are currently planned, but this may change. There are rumours that the BBC, who already broadcast BBC World and BBC Prime (in digital) from this position, may also lease transponders on Hot Bird 3.

19.24 Deg E ASTRA 1A - G The AstraVision promotional on Astra 1D transponder 57 closed for a time in September in favour of Sky News but in digital form (it may well have returned by now). Sky News was carried in MPEG-2/clear, with the parameters SR20000, FEC3/4, and the PIDs V0200-A0280.

From the Post Bag

Yet another full postbag and mailbox reflecting the fact that CQTV gets read by many ATV enthusiasts outside the UK. John, G7WHX wrote in asking for details on the ability of the next release of MS Windows to cope with digital TV pictures. Although not able to answer John's question specifically with regard to Windows 98 there is a growing tendency for Internet Browser software to include MPEG capability using plug ins for the purpose of viewing movie clips and pop videos etc. The point I made to John in my reply is that full length movies take gigabytes of disc storage and at current internet speeds download is not viable. Even with high speed satellite delivered internet data (Direct PC downloads at an equivalent 200kbit/s) in my opinion it is unlikely that the PC will be the medium for watching digital TV. The real choice is between DTH satellite delivery or cable where bit rates are typically 8Mbit/s and upwards.

Jim, G0FZB asked in another letter for advice in getting his old BSB Ferguson SRB1 to receive Channel 5. The Ferguson SRB1 was originally designed for the now defunct BSB service from 31 Deg W. It was designed as a DMAC only receiver but has been widely converted to receive PAL and D2Mac transmissions. The original receiver had an input IF range of 950 Mhz to 1350Mhz. This is fine for Astra Transponders 1 through to 48 as they fall within this range ie., Assuming LNB Local Oscillator is 10GHz then;

Tp 1 @ 11.214GHz gives an IF of 1.214 GHz.

Tp 48 @ 11.185 GHz gives an IF of 1.185 GHz.

Astra 1D which has Channel 5 on Tp 63 is in the range 10.714GHz to 10.935 GHz. Therefore ;

Tp 49 @ 10.714 GHz gives an IF of 714 Mhz

Tp 64 @ 10.935 GHz gives an IF of 935 Mhz.

As you can see your SRB1 misses these frequencies. There are several choices to receive Channel 5.

Upgrade to a receiver which has an extended IF of 700 Mhz to 2050 GHz

Change your LNB to one with a Local Oscillator at 9.75GHz.

Use a Frequency Extender (sold widely and advertised in the Satellite Press)

Gregory Smiaris, SV2RR, wrote giving details of reception equipment at his QTH. He uses a 1.4 m offset antenna, 0.7db LNB and can receive signals from 68.5E to 25 Deg W. Gregory also asked for details on

specific transponder allocations. For up to date information I know of no better source than the SATCO DX Internet page on <http://www.satcodx.com>.

Dammika Fernando, 4S7DF in Sri Lanka was interested in more details about the Pace DVR 500 and 510. Dammika has a business in radio communication and satellite work and will find information on its way.

Russell Greenberg made a couple of points in his E-Mail noting that Galavision with its shortened hours on Astra is still available in clear PAL on PAS-1 at 45W. Russel's equipment is all Pace, using PRD900 modified for enhanced lnb, Pace D150D-Mac decoder and MSP995 positioner. Using a motorised 1m Lenson Heath dish and Chapparral 0.7db LNB he can receive signals from 45E to 45W from his North London location. Russel asks if anyone can give guidance on what size dish is needed to get AMOS-1 at 4W. The footprint map below (courtesy of Swedish Microwave) shows that the UK is well outside the planned coverage area. I can only receive P1/P2 signals here at best with maximum threshold extension. Can anybody offer improved results ?

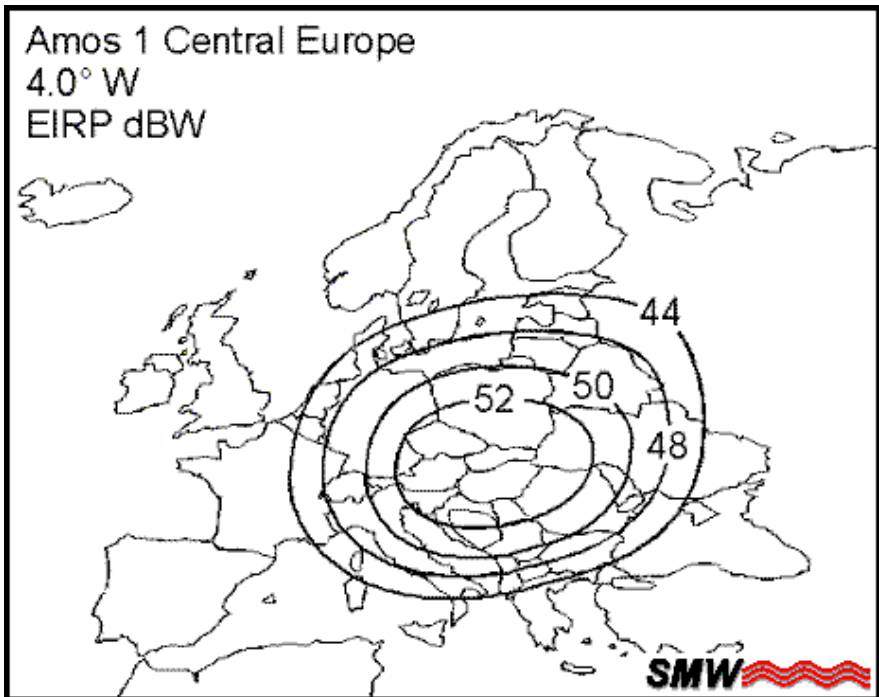

One chip does it all

CommQuest Technologies Inc. introduced their next generation single chip Digital Broadcast Satellite (DBS) receiver for consumer Set Top Box and satellite PC applications. The chip, designated the CQT6020, is one of the most highly integrated devices specifically designed to minimise system integration issues and to reduce cost of the front-end satellite demodulation subsystem. The CQT6020 DBS-XL, a single chip front-end satellite receiver, is available for sampling now. The CQT6020 is priced at US\$10 - in quantities of 100,000! The schematic below illustrates the complexity of integrating components of a typical digital receiver.

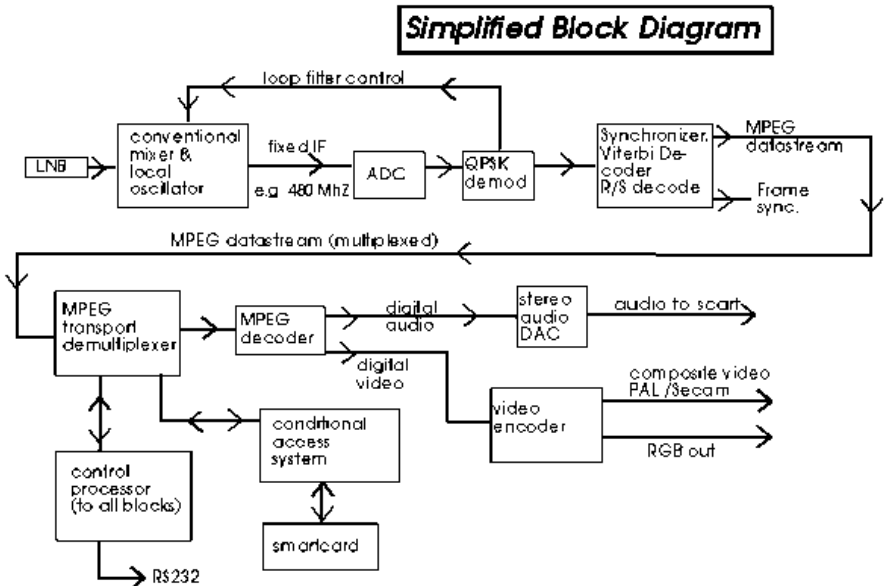

Conclusion

That's it again for another marathon edition of Satellite TV News. Please keep the letters and E-Mails coming and I will look forward to bringing you all the latest news from around the Clark Belt in the next issue.

All e-mail's to satnews@batc.org.uk

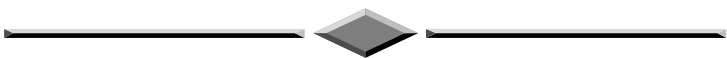

An American in ANTA (the French ATV organisation)

John Jaminet, W3HMS, an American member of BATC describes a visit to see how ATV in action, French-style.

I had heard of ANTA, “L'Association Nationale de Television Amateur” of France from the Swiss ATV Association News. I am a member of this fine association and also of the BATC. I had only received in October ANTA's first three editions and I was much impressed with their high technical quality and their skilful use of colour.

My adventure started innocently enough. I was sitting at my station/office writing-desk on the first day of November when at 1200 the phone rang. It was Michel Amiard F6ANO, the President of ANTA and he called me from Paris to discuss my request for reciprocal translation and publication rights between ANTA's quarterly magazine, B5+, and ATVQ, the American ATV magazine. Now Michel speaks good English and I always like to speak French when the occasion is at hand.. ..and it was!!!! Forty minutes later we had discussed in two languages all major factors of ATV on each side of the Atlantic during which he had casually mentioned that their General Assembly was to be held at Tours about 100 miles south of Paris on Saturday 9th November. Thank God it was his bill!

Now it is a fact that my wife and I had arrived at the Dover air force base on 17th October to catch a C5A Space-Available for Ramstein, Germany which was feasible as I am a retired Naval Reserve Captain. This trip to the Swiss ATV General Assembly on 19 October near Lausanne was still-born when I learned that the flight was cancelled and none were available in the time window essential for our arrival in Switzerland. It did occur to me that I already had my European railroad ticket good for five days in Switzerland, France and Germany so I needed only to get some cash. So I casually called Dover AFB and found that they had three C5A flights on Wednesday before the Saturday meeting.

So, I did what all wives wish their husbands would do, I called my wife, Velma, and said: “Honey, would you like to spend the weekend in France?” She gulped and said, later, she had too much work but I could go by myself. So I checked the space available schedule on Tuesday 5 November at 1600 and made the decision GO GO GO!!! I left the house Wednesday 6th November at 14.00 and we left Dover AFB at 23.30 on a C5A, the world's largest plane, arriving at Ramstein AFB, Germany, about 13.30 Thursday 7th November. I took a train to Paris, arriving about 21.30 and I called Michel from my hotel in Paris. “I am here,” I said and he was very, very astonished! So, we went to a small French bar near my hotel in Neuilly-sur-Seine not far from Paris to wash away the “air and road dust”.

An American in ANTA (the French ATV organisation)

The bar had the typical and charming French ambiance as we see in the American movies.

On Friday 8th November I went to the Orsay museum and to the Louvre. It was easy to just walk in during the winter... I alone was the waiting line!

On Friday night about 19.45, Annie (Michel's wife), Michel, and I drove 100 miles together, much in slow Friday night Paris suburban traffic. We had lots of time to chat and we did! During our talks, I mentioned I was a member of Toastmasters International, the public speaking organisation, and as such, I was used to speaking in public, although never in French.

The meeting was held at the Hotel Aster, 238 Avenue Charles de Gaulle at Saint-Cyr-sur-Loire near Tours. The morning session was gavelled to order at 09.45 by President Michel, F6ANO. He introduced me, as the only overseas member in attendance, and others. He reviewed the actions taken and successes achieved in 1996 by the group, which included several representations by ANTA to the French government's communication commission and to the REF, their RSGB equivalent. Then he thanked the authors of the many fine articles in B5+ and had the group observe one minute of silence for the Silent Keys. ANTA has today 438 members after only starting in the Spring of 1995. I think ANTA has a very fine quarterly magazine, B5+ (it is B5+ in Europe, same as P5+ in the USA and Britain). Their sister organisation is the Swiss ATV Association of which Michel Vonlanthen, HB9AFO is the President. Both presidents are members of the other organisation, as are other members of each association. I myself am a member of both. Michel also observed that amateur radio happenings with the FCC in the USA can affect French hams and others. They now have 14 ATV repeaters on the air in France. Their 1997 meeting will be held in Strasbourg, France on 8 November. Michel stressed the need to use and to defend their ATV frequencies.

Physically, the setting was a medium sized motel with conference room near Tours, 100 miles south west of Paris. There were about 40 to 50 people in attendance from throughout France from their 414 members. Like our ham organisations in the USA, it is a totally national language-speaking organisation. For me, it was a total immersion in the French language and culture... and it was great!... but not a tourist thing to do any more than are the US organisations a tourist thing for overseas members. I had made considerable progress in French vocabulary building and in my comfort level in speaking with people, but this was always a one-on-one, two or three thing. I had other concerns: would I 'fold' or make a fool of myself? Would I 'freeze' and fail to find the words I needed? Heck, we all do this here and if I froze, I could always claim to be 81 years old and afflicted with periodic seizures. Could I use their mike with one hand,

make gestures with another, and use no script? Would I try some funny lines... and get stares?

I spoke about fifteen to twenty minutes and covered: - the story of how I came to go to France (as above); - our 70 cm television repeater in York, Pennsylvania; - typical local amateur television operation - common equipment used by local hams; - the W3HMS television station; - my new tower with the climbing collar, the Hazer; - - questions and answers.

They asked, among other things, about the number of hams in the US and the number of ATV hams, the quality of representation of ATVers and hams in general by the ARRL to the FCC. I answered all questions honestly and as my opinion.

My impressions: I was less nervous than expected in my speaking and I surprised myself. The humour seemed about right, if something was funny they laughed, if it wasn't they didn't, not like US commercial TV with dull plots and laugh machines. A double translation was necessary on measures: 50 feet makes little sense, 16 metres is real. I received a nice applause and they bought my \$20 lunch. People chatted easily with me one-on-one after my talk. Some said candidly that they studied English in school but with few occasions to use it, they forgot it... just like, in reverse, the good old USA!

In discussing public knowledge and opinion of hams in the USA and in France on the way from Tours to Paris, I was quite surprised to learn that French hams are not allowed to perform public service such as we do and for which we have our biggest claim to fame in the minds of the public. I related my experience with a 150-mile bicycle rally in July where 25 or so hams provided communications at the security-check zones, all for the security and well-being of the riders. I suggested that, in my view, the hams in each nation are missing a critical success factor for the longevity of hamdom if they are not allowed to perform public service.

I was quite impressed with the technical skills in their use of 13 and 23cm, of FM for ATV, and of 10GHz activities using modified TV Satellite LNBS. I think they are technically ahead of us by a discernible margin.

I am also impressed with their sister organisation, the Swiss ATV Association under Michel Vonlanthen, HB9AF0, President, which has been in business only since early 1995 and with a sizeable membership and excellent bulletin.

Hearing Michel, F6ANO, stress the point of frequency use and defence of amateur frequencies made the need for each nation to have an ATV organisation axiomatic. That we do not have one in the USA is regrettable and can only work to our detriment. Heck, we don't even know how many of us there are in ATV! Once ATVers in the major countries set up their

An American in ANTA (the French ATV organisation)

national organisation, there is a major need for an umbrella organisation at the intercontinental level. In an umbrella organisation, all national groups retain their autonomy just as members retain their own names, calls, etc. in their own organisations. I know this is possible as more than 20 US veterans organisations have put one in place in Washington, DC and ATV hams should be able to be as creative as veterans. The umbrella organisation could issue a periodic newsletter in three to four major languages. Internet e-mails could be the linking medium.

The problems on each side of the Atlantic are about the same, e.g. hams are busy people with their jobs, families, civic/political activities, their other hobbies and of course ham radio and funding all the above. People are very busy!

ATVers are a very small percentage of the total number of hams in both the US and in France. As a result, ATVers may not receive what they consider to be proportional support by their national ham radio organisation.

The trip home was via train to Ramstein, bus to Frankfurt, charter L- 1011 to Dulles near DC and car to the QTH, all without sleep for about 40 hours! It was a superb trip in all major aspects. We ATV hams are very fortunate to find active, intelligent, gracious, and well-informed ATV colleagues in other lands.

Footnote: John is now working hard with others to set up a national ATV organisation for the USA and feels that EATWG, the European ATV Working Group, could be revived and expanded to form the international umbrella group he describes in this article. The BATC will of course give him every assistance in this.

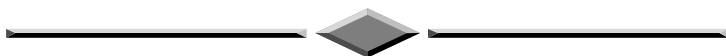

**Please mention that you saw
it in CQ-TV when responding
to advertisers.**

By Juergen Meyer DL3FY

Could ATV reception be possible for an amateur with 'normal' antenna set-ups? The author decided to work this out for himself and the results are printed in this report.

The next question to arise was how much deviation from the nominal frequency would be created by the Doppler Effect on the 13cm band.

How and why this began

The 'why' is clear from the heading, whilst the how will become apparent from this report. As you can read in reference [1], ATV experiments are planned for the L- and S-Band equipment aboard the space station MIR. Since it is likely that after a while following commissioning of the equipment it will operate as a normal ATV 23/13cm transponder, I (and others) felt the desire to take part in these ATV transmissions and see the results on my own screen.

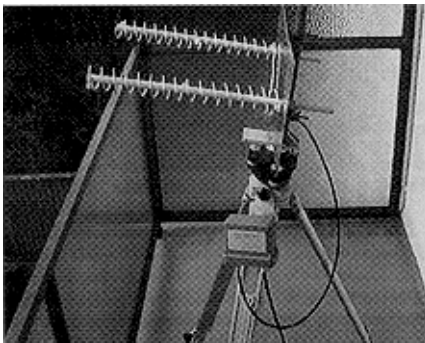

Fig. 1: My test equipment -- two 16-element helical antennas and the S-Band converter from SSB-Elektronik.

In technical circles, however, it was considered that this would be possible only with large dishes (2 metres diameter and upwards) which also tracked the course of the satellite precisely. I did not have these facilities and recognising my limitations, I let the matter drop. Then I read a report by James G3RUH in [2], also one by Gerd DK3AX in [3] on the subject of satellite reception in S-Band. My enthusiasm renewed, I started a couple of experiments of my own. Since

the satellite OSCAR 13 was clearly no longer available for use, the alternatives were UO-11, AO-16 and DO-17, which were producing signals in S-Band.

The frequencies in question can be found in [4], whilst anyone wishing to learn more about satellites and satellite techniques can read [6] and [7] for assistance.

The signals sent by these satellites were, however, narrowband and my equipment available was not suitable for these. What to do? I needed a suitable converter, one which worked impeccably. That rather eliminated the idea of the home-brew effort I had already considered. On the recommendation of the company SSB Elektronik and with their kindness I received for these trials a purpose-built converter (UEK-2000 SAT) for transposing the 13cm signals.

The converter transposes linearly to the 2 metre band; the frequency 2,400MHz comes out as 144MHz. In its masthead version it possesses a HEMT preamplifier stage with very high input sensitivity and very low noise (0.6dB). The total noise figure is given as 1.0dB. Preselectivity is very good thanks to a 2-pole helical filter, whilst a Schottky ring mixer provides good performance in the face of large signals.

FODTRACK 2.0		SATELLITE TRACKING SYSTEM		by XQ2FOD	
31-MAR-97 02:32:40		Status: Tracking MIR			
Satellite position		Latitude:	51.62	Your Keps for MIR are 3 days old. This will give high precision.	
	Longitude:	14.92			
	Altitude:	404.4			
	Phase:	150.35			
Seen from DL3FY		Azimuth:	109.53	AOS: 02:26:33 LOS: 02:37:02 Max El: 65.8	
	Elevation:	39.11			
	Ground distance:	442.7			
	Straight distance:	605.7			
Rotator status		Flipping:	Disabled	FodTrack commands: Automatic Manual Quit Track Tune Stop Calibrate	
	Azimuth:	109.53			
	Elevation:	39.11			
Frequency	TX: 145802.5	RX: 2409958.9			
Satellite selection: Automatic					

Fig. 2: FODTRACK, a satellite-tracking program. RX indicates the receive frequency as influenced by the Doppler shift (nominal frequency is 2410MHz).

I received the aforementioned converter shortly after the 'contact conversation' and was now obligated to provide an antenna for it. For the first trials I used a 2.25-turn helix, as described in the articles mentioned, and a 60cm offset dish. I was disappointed; nothing was heard. I assumed this was something to do with antenna alignment; I did not use my mast and KR-5600 rotator but instead erected a three-legged tripod and turned the aerials by hand. I had already tried this method on 13cm and 10GHz and knew how difficult it was but I had to try.

Next I used a helix with 16 turns -- see [3] -- and mounted this with an aluminium reflector. The converter connected, I tried anew. Since to my knowledge there was no software that could handle this particular tracking exercise, I was forced to make manual adjustments to the receiver (IC-

820H) at the same time as trying to keep the antenna aligned on the satellite (I could have done with extra hands and longer arms!). With the satellite DO-17 it finally worked and I could hear a signal although what modulation it had, if any, was unclear. With 3 to 10dB over the noise of the converter it was not loud enough but at least it was a small success. Accordingly I knocked up a second helix to mount on the reflector and this appeared to make an improvement, although the situation was probably never identical. Incidentally, I made many attempts to get signals from AO-16 and UO-11; the latter was heard but only about 3dB above noise level. The more than 10,000km distance ruled out hearing the AO-16 satellite.



Figure 5. Will amateur television reception from Mir turn out to be possible for the average amateur -- or not?

A satellite tracking program is required urgently

For finding out when the satellite rose above the horizon, when it 'set' and how long it was up in the air, a tracking program was needed. It is even better if this can supply azimuth and elevation information. Such a program is FODTRACK, which is mentioned briefly in [5] and its appearance is shown in fig. 2. The three most important results are shown under Azimuth, Elevation and RX. Obviously another program could be used instead. For tabular information and predictions FODTRACK is of

no help and a program by DK1TB has given good service. FODTRACK has advantages over other tracking programs in that it does not limit the frequency input.

TAG	UTC	AZ	EL	MA	Distance	Orbit-Nr.	2m-Freq.
DO -17, Frequenz 2401,2205 MHz							
14.3.97	12:41	7,3	1,2	238,5	3120 km	37272	145,2652
	12:43	357,8	8,7	243,5	2424 km		145,2601
	12:45	340,5	17,5	248,6	1851 km		145,2458
	12:47	310,0	24,0	253,7	1558 km		145,2242
	12:49	275,9	20,5	2,8	1699 km		145,1935
	12:51	254,2	11,8	7,9	2191 km		145,1787
	12:53	242,4	3,8	13,0	2852 km		145,1703

Fig. 3: Two-minute data listing for a DO-17 pass.

Looking at the listings given in figs. 3 and 4 we find a Doppler shift of 94.9kHz, indicating a +/- 47.45kHz deviation from the nominal frequency of DO-17 and +/- 46.65kHz deviation from the indicated downlink frequency of MIR. The transit times and distances are comparable, although it is also necessary to take into consideration transmit powers, antenna types and bandwidths.

TAG	UTC	AZ	EL	MA	Distance	Orbit-Nr.1	3cmQRG
MIR, Frequenz 2410 MHz (vorgesehene Downlink -Frequenz)							
22.3.97	01:13	203,8	0,3	143,2	2223	63341	2410,0473
	01:15	187,2	7,6	148,7	1566		2410,0380
	01:17	153,2	14,1	154,3	1191		2410,0080
	01:19	112,4	10,9	159,8	1362		2409,9716
	01:21	89,6	3,2	165,3	1938		2409,9540

Fig. 4: Two-minute data listing for a MIR pass.

Mounting the antennas and computer control

Attempts with the antennas indoors were promising so the twin 16-turn helix array was now fixed to my antenna mast at a height of about 12 metres above ground level. This allowed it to be controlled in azimuth and elevation using FODTRACK. The first satellite transits (DO-17 orbits nos. 37401 and 37402 on 23rd March 1997) already brought a noticeable

increase in signal strength. Instruments showed field strengths reaching S9 +10dB at times, although at other times they almost disappeared. I had to take into consideration that the S-meter of the receiver (IC-820H) already indicated 20dB with signal input. Over longer periods the field strengths lay around S9; that is 9 times 6dB = 54dB - 20dB, in other words more than 30dB above the noise. On a few later transits this even reached S9 + 20dB, more than 40dB above noise!



Figure 6.The downconverter used for these trials was the UEK-2000 from SSB Electronic (available in the UK from Piper Communications, Berks.).

Satellite transmit power, antenna types and bandwidth, also calculation of achievable signal to noise ratios

The transmit power expected from the 10MHz-wide ATV signals from MIR amounts to 10 watts, with no antenna gain from the antenna system used. Transmit power from DO-17 should be around 1 watt and I cannot determine the kind of antenna used. G3RUH's article [2] gives a method of calculating the signal to noise ratio and calculations were made in this fashion for DO-17 and MIR. In the article a 60cm dish was discussed although in fact a twin helix would more likely be used. The distances for the two satellites DO-17 and MIR were given as 2,000km. The bandwidths for DO-17 (2.7kHz) and for MIR (10MHz) were taken into consideration.

Using the formulae

$$\begin{aligned} P_r &= P_t \cdot (D^{1/2}) / (4 \cdot R^2) \\ P_n &= K \cdot T \cdot B \\ \text{SNR} &= P_r / P_n \end{aligned}$$

we get for DO-17:

$$P_r = 0.25 \times 10^{-14} \text{ [watts]}$$

$$P_n = 4.47 \times 10^{-18} \text{ [watts]}$$

$$\text{SNR} = 1.677 \times 10^3 \text{ corresponding to } 27\text{dB}$$

and for MIR (ATV bandwidth 10MHz)

$$P_r = 1 \times 10^{-13} \text{ [watts]}$$

$$P_n = 1.656 \times 10^{-14} \text{ [watts]}$$

$$\text{SNR} = 6 \text{ corresponding to } 7.5\text{dB}$$

For a good ATV picture at least 10dB is necessary. At half distance, that is 1,000km (distances of even 500km are possible with MIR!) signal to noise ratios of 6dB can be considered, giving a value of at least 13.5dB. Comparing the value calculated for DO-17 this looks relatively good. Once could easily achieve an extra couple of dB if a quadruple helix antenna array were to be used.

Is ATV reception from MIR possible for the average ATVer?

I cannot give an unequivocal answer from the information available but it certainly lies within the realms of possibility. We shall just have to wait until a heavenly ATV test pattern (RR0DL) is transmitted by MIR!

The influence of the Doppler effect on ATV pictures can be dismissed as irrelevant, since it would have to be at least a few hundred kHz to be of any importance. One thing is sure: a very sensitive converter is absolutely crucial and the Arabsat converter from California Amplifier (with 62dB gain) is a candidate.

Closing thoughts

Perhaps a heated -- and I hope, productive -- debate will arise from this article. That would be no bad thing. Many thanks to Bernd Bartowiack DK1VA of SSB Elektronik for the loan of the converter and to Heinz Venhaus for mediating.

References

- [1] Neue Amateurfunkstation RR0DL in der Raumstation MIR, by DL2MDE in CQ-DL 12/94, pp 854-856.
- [2] Mode S, das Downlink von Morgen? by G3RUH in CQ-DL 9/93, pp 614-617.
- [3] Schrottverwertung oder Wie mache ich billig S-Band Satellitenbetrieb? by DK3AX in CQ-DL 2/93, pp 115-117.
- [4] Benutzerfrequenzen der Amateurfunk-Satelliten, by DF5DP in CQ-DL 11/96, p 902.
- [5] Einfaches Interface fuer (SAT-) Antennen-Rotorsteuerung, by DL3FY in TV-AMATEUR 104 (1st quarter 1997).
- [6] Tips zum Satellitenfunk (1), by DL2DUL in FA 6/94, pp 468-469.
- [7] AMSAT-DL Satellitenhandbuch, by DJ6PJ, DL6DBN and DF5DP.



Yet another view of the BATC stand at the IBC

Experimenting with Video

By Robin Abbott

This article first appeared in ETI magazine, Volume 26 No. 1, February 1997.

This first part introduces video signals and constructs a sync separator module that can be incorporated into other circuits, for example a multi-function fader-wiper.

In recent years, with the increasing affordability of camcorders and other video sources, the operation and construction of electronic projects involving video signals has been of greater interest to electronics constructors.

Virtually all video recorders, camcorders and increasingly computer systems and video games are equipped with composite video outputs, and sometimes input connectors. In this series, we shall look at the operation of the composite video signal and how it may be manipulated. We will look at some techniques for manipulating the signal, some typical video building blocks, and how to construct faders, wipers, mixers, and test equipment.

The composite video signal

The composite video signal is so named because it is a single analogue signal, which contains the brightness (known as luminosity), colour, and synchronisation information necessary to display a complete colour picture. On a TV broadcast, it also contains Teletext signals, which are not normally visible. It is sometimes described as a baseband video signal. The signal has a bandwidth of approximately 4MHz for black and white (monochrome), and

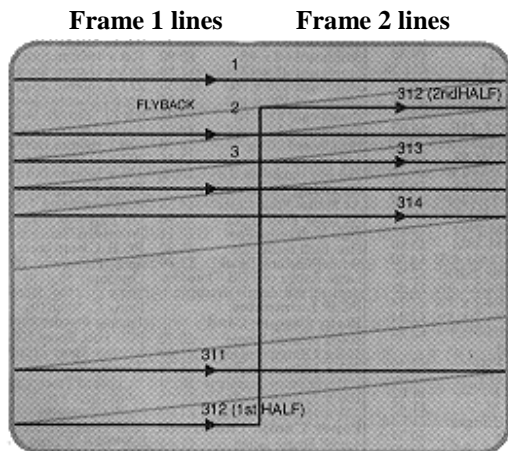

Fig1. Frame displayed on CRT

Experimenting with Video

approximately 6MHz for colour. The signal has a DC content which, as we will see, can cause us some problems.

A frame is a complete picture displayed on a monitor or a television receiver. In this series we will look only at standard TV frames in the UK video system (although foreign systems are similar; but with differing details such as number of lines, frame rate, and method of colour encoding). A complete frame is included in the composite video signal once in every 40 milliseconds, resulting in 25 frames (or cycles) per second. If we were to view a TV picture at this frame rate, however, it would flicker unpleasantly. To overcome this problem the picture frame is split into two halves, and one half is sent every 20ms to result in a 50Hz display rate.

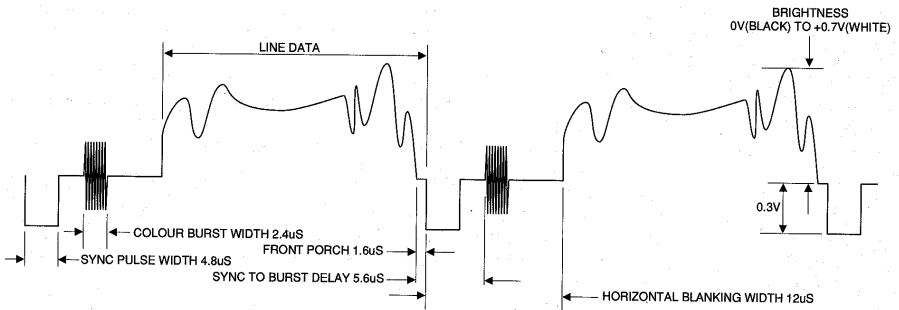

Fig 2. Lines of picture information.

The two frame halves are split such that one half displays odd lines of the frame, and one the even lines of the frame. The persistence of the cathode ray tube (CRT) is such that the two halves appear to come together to make a single frame at the 50Hz rate. A frame half is referred to as a field.

The frame is made up of 625 lines, and each field includes 312.5 lines. Figure 1 shows the composition of a single frame on a CRT. Each line takes 64µs.

The composite video signal must include information to signal to the monitor the start of each line, the start of each field, and whether a field forms the odd or even half of the frame. These signals are the synchronising (or sync) signals. The lowest level of the luminance signal defines the black level, and a signal level below the black level can be used to define the start of each line, and the start of each field. The level of the signal drops to -0.3V to indicate sync information. We will consider the black level to be 0V (in practice as we shall see this is usually not the case, although in the designs that follow the video signal is adjusted to ensure this). Figure 2 shows two complete lines of video information.

Note that the signal drops to the black level (0V) at the end of each line for $1.6\mu\text{s}$. This is called the front porch. It then drops to -0.3V for a period of $4.7\mu\text{s}$ to allow the monitor circuits to return the electron beam to the start of the next line. There then follows a period when the signal is at the black level, defining black for the following line for the receiver. This period (called the back porch) lasts for $5.7\mu\text{s}$, and then the line information starts. During the back porch, for a $2\mu\text{s}$ period a burst of the colour subcarrier is sent, which is used to lock the internal oscillator of the monitor to the colour signal and to allow the colour signals to be demodulated.

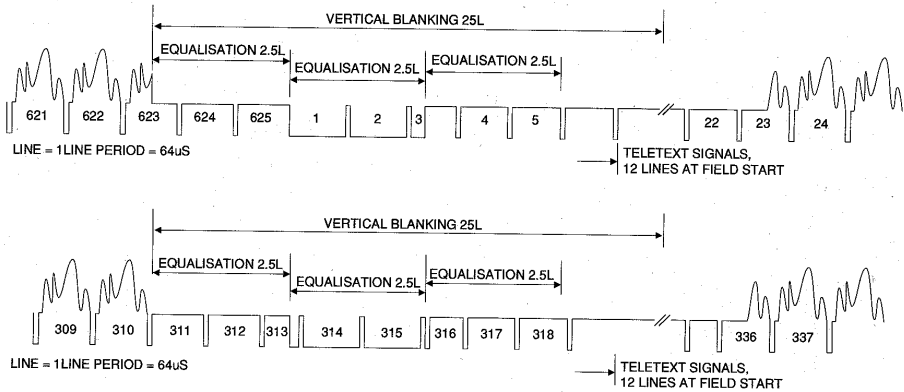

Fig 3. Field synchronisation signals (for clarity, equalisation pulses are not shown)

Thus, the $64\mu\text{s}$ line time contains video information and $12\mu\text{s}$ to define the end of line, the black level, and to send the colour synchronising signal. This $12\mu\text{s}$ period is described as the line blanking interval - no information is displayed on the screen during this period.

The video information is carried as a simple brightness (or luminosity) signal, with colour modulated onto this basic signal. The luminosity signal varies from 0V (which is black) to 0.7V (which represents white), with shades of grey in between. The electron beam in the receiver sweeps from the left-hand side of the CRT to the right, so that the information sent immediately after the back porch is the information on the left of the screen. If you have an oscilloscope and a camcorder it is possible to test this, and careful adjustment of the trigger level can allow a reasonable display of a line. Point the camcorder at a piece of white paper and place a black card half way across the lens. The difference in the signal should be clearly visible.

Colour information is sent as a subcarrier at 4.433MHz . The composition and use of the colour signal is beyond the scope of this first article, but it is

important to note its presence, and in particular it is very important to maintain the amplitude and phase of the colour burst during the back porch to ensure a stable colour picture.

Frame synchronisation

Frame synchronisation is complex. A full understanding of frame synchronisation is not essential to experiment with video, but an explanation is presented here for completeness. Figure 3 shows the end of a frame. For a period of 25 lines, the field information is blanked to allow the monitor to return the electron beam to the top of the CRT. During the latter part of this period (when there is no opportunity for the monitor to display any information) the TV transmission authorities superimpose Teletext data on the signal during the line.

At the end of each field, a field sync pulse is sent which lasts 2.5 lines (160 μ s). As for the line synchronisation signals, this pulse is at a level of -0.3V. However, the monitor must still detect the start of each line during this period to start the lines correctly when the field sync pulse is complete. For this reason, the field sync pulse is temporarily removed just before the line sync pulse so that the signal level is 0V instead of -0.3V just preceding the line sync pulse. This means that the falling edge of the sync pulse is in the same place as before, and that there is what looks like an inverted line sync pulse before the line sync period. Monitors and TVs operate on the falling edge of the pulse, so that they continue to detect line pulses correctly.

TVs and monitors usually generate the timing signals for lines using analogue circuitry. One field ends half way through a line, while the other field ends at the normal end of a line. Thus the field sync pulse arrives in one field closer to the last line sync pulse than in the other. The analogue circuitry for the frame sync detection is upset by this disparity, so “equalising pulses” are included in the lines before, during and after the frame sync pulse. These pulses are sent halfway through each line, they ensure that prior to the field blanking interval there are the same number of transitions below the black level, and correct the frame sync problem. It is necessary to be aware of these signals when counting lines as some line sync detectors will trigger on the equalising pulses as well as line sync pulses.

Driving a composite video signal is straightforward. Virtually all devices with a composite video signal input terminate it with a 75ohm resistor, so any device driving a video input should provide an output of double amplitude with a 75ohm resistor in series with the output. Similarly, inputs should be terminated with a 75 ohm resistor (unless they are intended to be used in parallel with other devices).

Fig 4. Circuit diagram.

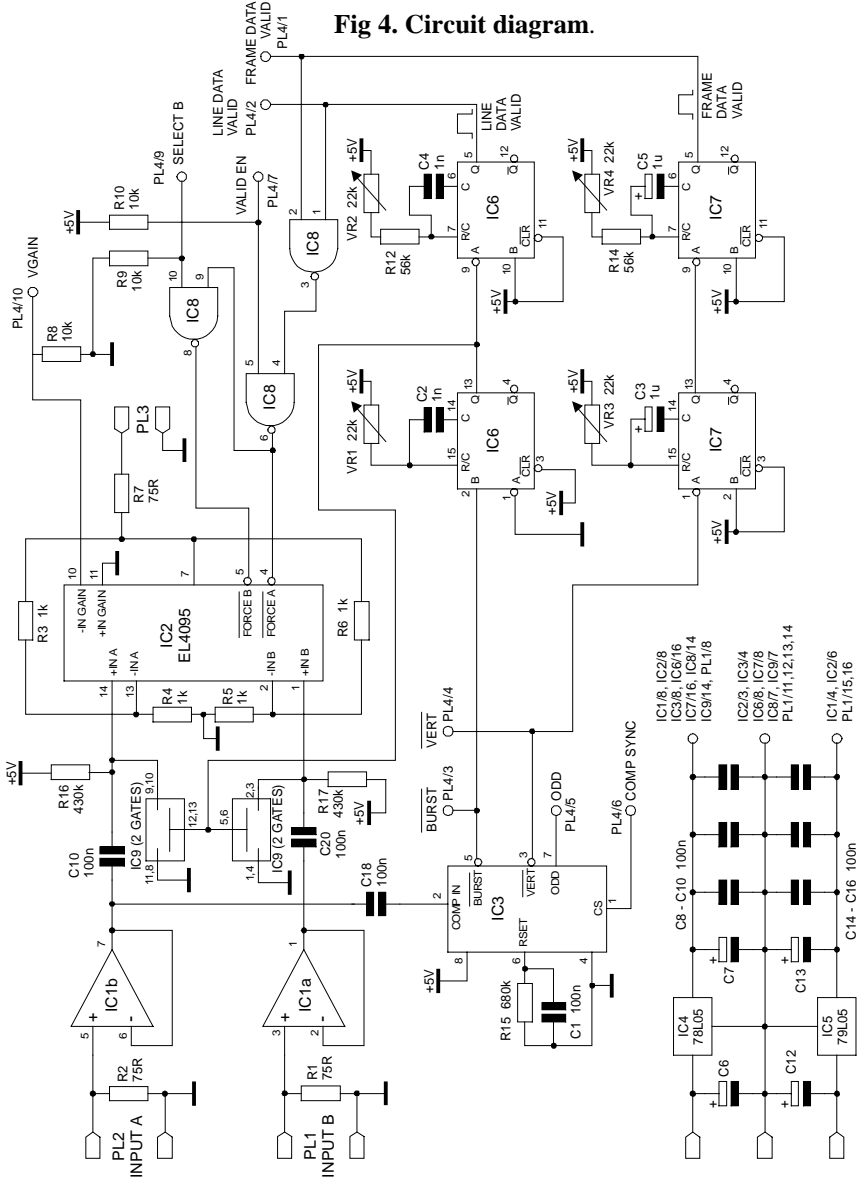

Video signals are sometimes provided on phono sockets, and phono leads can be used to connect devices together. Most recent equipment also includes a SCART socket. This type of socket is multi-function and amongst other signals carries composite video signal inputs and outputs, as well as stereo and mono audio information. All the projects that we will

Experimenting with Video

look at can make use of the SCART socket or phono sockets. The latest high band video equipment (Hi-8 and SVHS) provides output on an S-Video connector. These are described below.

The sync separator

In this article we shall look at the design and construction of a general-purpose video buffer, sync separator and regenerator. This is an essential building block of any project which is to modify the composite video signal. The sync separator provides the following functions:

- Input buffer for two video signals.
- DC restoration for each signal (see below).
- Voltage controlled mixer to control gain of each channel and mix the channels to a common output channel. This provides fading or mixing.
- Output buffer.
- Synchronisation signal detection.
- Line and frame valid signals which may be used to control mixing and wiping - however we manipulate the video signal we must ensure that the line and frame sync pulses are maintained because any operation which affected these sync signals would destroy the ability of a monitor to display the frames, and this function is provided on this board.
- Fast switch to restore original sync signals.

We shall also look at how the circuit may be used at the heart of a sophisticated multi function fader/wiper. In the next article we shall extend this to a full video mixer/fader/wiper which is digitally controlled and, apart from keyboard operation, may be controlled over a serial link from a PC or other computer to provide pre-programmed effects.

The circuit

Fortunately, many useful video functions have been provided in integrated form. In this project, we will be using the ELANTEC series of video buffers and control blocks.

Figure 4 shows the circuit diagram of the sync separator and regenerator. IC1a and IC1b provide unity gain buffering for the input signals. These are wide band op-amps, which have a unity gain bandwidth which extends into tens of megahertz. The inputs are terminated with 75ohm resistors. If there is no signal on the B input then fading and wiping to channel B will fade and wipe to black.

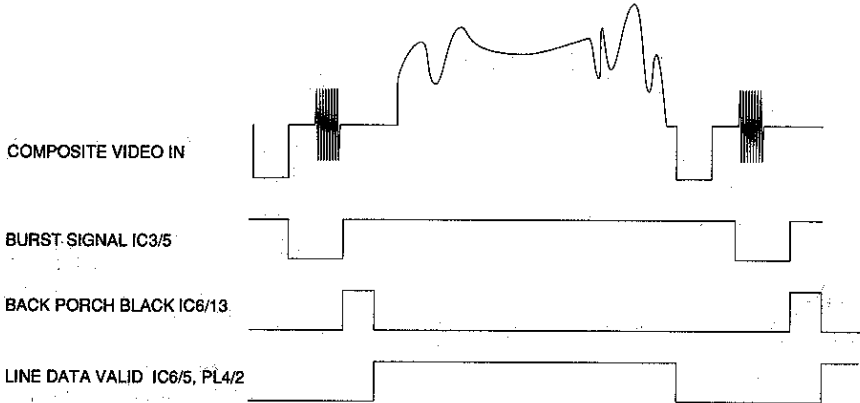

Fig 5a. Waveform from different parts of the sync separator circuit

From the output of IC1b (which is the buffered output from channel A), the sync circuit determines the line and frame synchronisation signals. This is achieved by IC3. This universal sync separator chip derives 4 output signals which are logic compatible. The burst signal goes low during the colour burst on each line. The vert signal goes low during the vertical sync period, and is generated on the first serration during the vertical sync period. The ODD output is high during odd fields and low in even fields. The composite sync output reproduces all the video input pulses.

Monostables

IC6 and IC7 are monostables used to derive useful signals for the rest of the circuit. IC6a is driven by the rising edge of the burst signal. It is timed to produce a pulse of about 4µs which is active during the period of the back porch following the colour burst. This is used in DC restoration (see below). The falling edge of this pulse defines the beginning of the line. IC6b is triggered by the falling edge of IC6a and is set to produce a pulse of about 52µs that is the same length as the data in the line. Thus, the output of IC6b is a signal, which is high during the line data, and low for

Experimenting with Video

the entire line-blanking period. This is used to switch the input signal directly to the output signal during line sync data.

In similar fashion, IC7 provides a signal, which is high for the entire period of the field, when there is no synchronisation data in the input signal. This is used to switch the input signal directly to the output signal during field sync data.

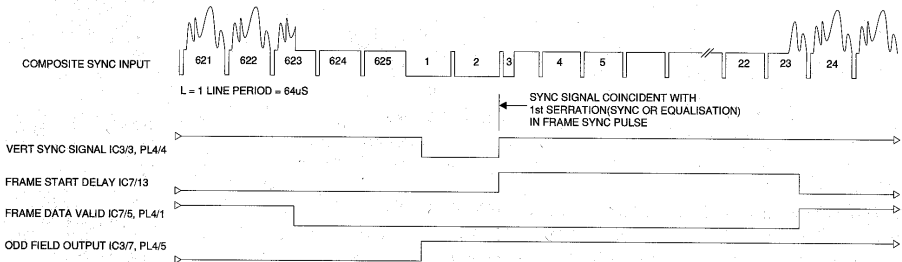

Fig 5b. Waveform from different parts of the sync separator circuit

Figure 5 shows the timing of signals around this circuit. C19 and C20 provide ac coupling from the input buffers into the next stage. Here we find the DC restoration circuit. The biggest problem with fading a video signal is that the average DC value of the composite video signal varies with the brightness of the signal. A white field will produce a video signal, which has a DC level, which are several hundred millivolts above the DC level of a black field. The result of this is that the black level varies with the type of picture being displayed. Any attempt to fade or wipe this signal to black (or white) will result in a blank field which will vary in shade of grey depending on the signal which is being faded. To overcome this it is necessary to bring the DC value of the black level back to a fixed level, in this case we choose ground so that an unused input appears as black.

DC restoration is traditionally accomplished using a diode clamp, however this does not guarantee restoration to ground during the back porch (recall that the back porch defines the black level). The post-burst pulse from IC6 is used to define this period and an analogue switch is used to short the signal to ground. R16 and R17 serve to pull up the signal during the period when the signal is not being clamped, and serve to make the black “blacker” which gives a better fade or wipe.

Integrated fader/mixer

IC2 is an integrated 2-channel fader/mixer IC. It has two inputs, A and B, and a gain control which defines the gain on each channel. The gain control should vary from -0.5V to +0.5V. When it is at the lowest voltage

then channel B has full gain, and channel A has zero gain. When at the highest voltage then channel B has zero gain, and channel A has full gain. Thus the gain input may be used to fade the signal between channels, or when there is only one channel, to fade to black. Please note that the input impedance of the gain control is very low within IC2 (about 5K), and therefore should always be driven from a buffer.

Fig 8. The component layout.

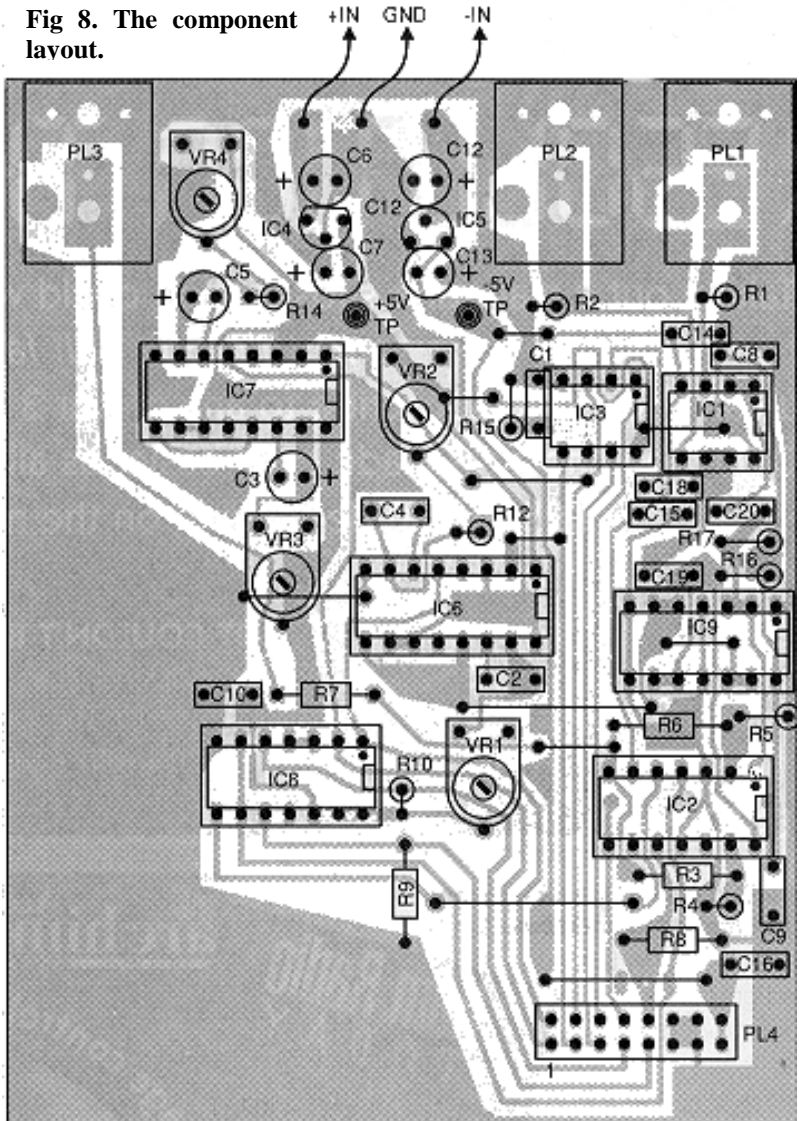

Experimenting with Video

IC2 also has an output amplifier, this is set to have a gain of +2 by R3, R4, R5 and R6 so that the output signal level (which is driven by a 75 ohm resistor) is at the right level when it is terminated correctly.

IC2 also has two inputs, which force the gain to full gain on one channel and zero gain on the other. These are the force A and force B inputs. These inputs are used to force the output to channel A during sync periods by the line data valid and frame data valid signals respectively. Whenever these signals are low (during sync periods) channel A is forced to full gain, so that sync signals are passed directly through without modification.

To achieve the wiping functions, channel A is turned off and full gain is given to channel B. This is achieved by IC8. Whenever the Select B input (pin 10 of IC8) is grounded then channel B is placed to full gain, and with no input signal to channel B, the output of the circuit will be at black level. However, IC8 also ensures that during sync periods, the output of the circuit is forced back to channel A.

There is a 16 way control connector provided on the board. This provides the following signals:

- Burst, vertical, odd and composite sync outputs from IC3. Line data valid from IC6.
- Field data valid from IC6.
- Input to force the output to take its input from input A or input B directly.
- The gain input to fade between channels A and B.
- Power supplies at -5V and +5V at about 50mA drive capacity.

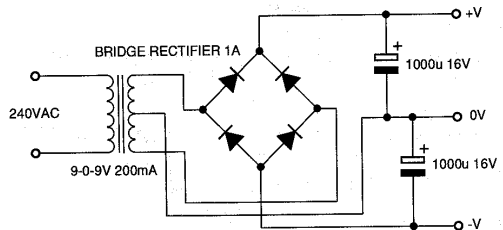

Fig 7. Simple power supply

Construction and setting up

A PCB has been designed for this project. However, layout is not critical as most of the signals are at a high level and low impedance, and stripboard techniques could be used for the construction of this circuit. Close decoupling of the power supplies to the video chips IC1 and IC2 is very important whatever technique is used for construction. Figure 6 shows the component layout for the board.

Fit the 11 wire links first, some of these run under other components, so stripped hook up wire is recommended. Next, in order, fit the IC sockets, the resistors, the capacitors (watch for polarity here), and the remaining components. The board mounted phono sockets are sold by Maplin, other phono sockets may require a different board layout. Do not fit the ICs into their sockets yet.

The board requires a power supply at $\pm 9V$. Figure 7 shows a suitable circuit (this will give nearly 12V each side – but the regulators will cope). To set the board up, connect the power supply and check the power supply pins of the IC sockets which should be at $\pm 5V$ as shown on the circuit diagram. Power down, insert the ICs into their sockets, and power up again. Connect a composite video signal to PL2 (the A input), and monitor the output from PL3. The output can be connected directly into a TV set via a phono or SCART socket, or through a video recorder or modulator. At this point the display will be at half brightness, and will probably be rolling.

If you have a dual trace oscilloscope, trigger it from IC3 pin 7, connect channel 1 to the input on one end of R2, and channel 2 to the IC pin 5 end of R1. Finally, set the trigger delay to examine a line about 5ms into the field. Now adjust VR1 so that the output on pin 13 ends just before the line data, connect channel 2 on pin 5 of IC6, and adjust VR2 so that the signal ends just before the front porch. Now increase the timebase and monitor the outputs of IC7 to adjust VR3 and VR4.

If you do not have an oscilloscope then connect pin 10 of IC8 to +5v (connect to one end of R9 - make sure it is the signal end!). Now the display on the monitor should be blank, although the picture may show around the edges. Adjust VR1 to bring the picture onto the left of the display slowly, back off until the picture disappears and is stable. Now adjust VR2 so that the picture just disappears on the right hand side. In similar fashion use VR3 to adjust the top of the picture, followed by VR4 to make the entire screen black, and stable.

Using the sync board for a multi-function fader/wiper

In this section, we will look briefly at a simple application of the sync circuit. With just two further ICs and a handful of other components, we can make a fader/wiper with the following functions:

- Fade picture out
- Wipe picture to left or right of screen
- Wipe picture to top or bottom of screen
- Direct switch of picture to black

Experimenting with Video

- Fade, switch or wipe (effects 1-4) to black, white or any shade of grey

Any of these functions may be combined, for example the picture can be wiped off to any corner of the screen by combining the two wipe effects.

In addition any of the fade or wipe functions can fade or wipe to the picture on input B. Note that this input must be synchronised with the input on Input A. Typically this may be the output of a character or caption generator, although these devices often include their own wiper/fader functions.

Figure 6 shows the extra components needed to make the fader/wiper. This circuit can be constructed on strip board. Do not fit PL4 on the sync board, simply wire the circuits of figure 6 directly to the holes for PL4. As much or as little of this circuit can be constructed depending which functions are required. The potentiometer controls in this circuit should be slide devices.

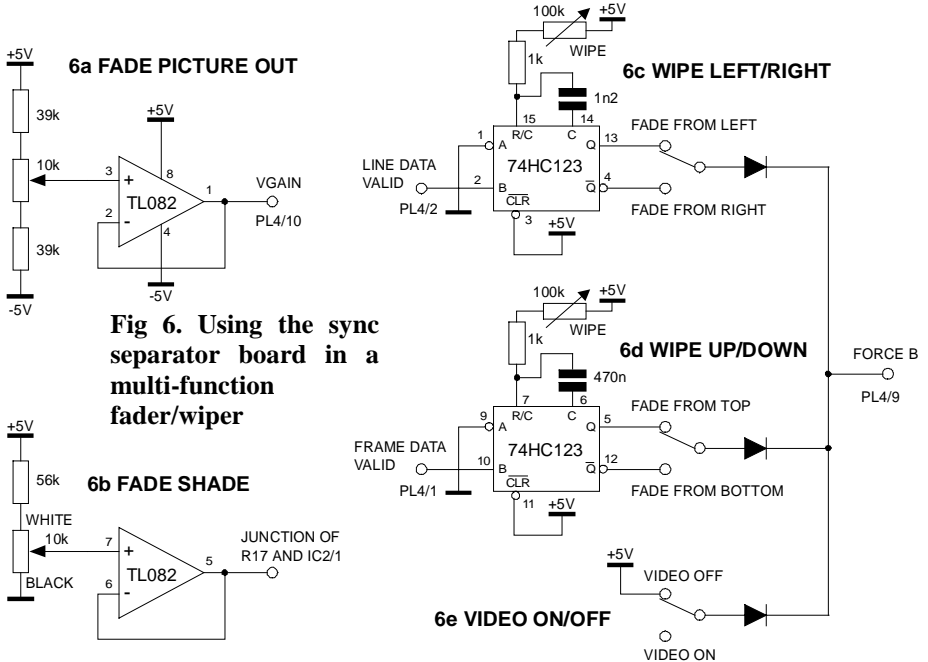

Fig 6. Using the sync separator board in a multi-function fader/wiper

Fade input A

Figure 6a shows the circuit for the variable gain control, which can be used to fade the video input to black, white or any shade between. The potentiometer and resistors are chosen to provide a voltage from -0.5V to +0.5V to control the gain input of IC2. The unity gain buffer matches to the low input impedance of the gain input of IC2.

Fade/wipe shade control

Figure 6b shows a simple control to force the wipe or fade shade to any brightness between black and white. The potentiometer and resistor are chosen to produce a luminosity voltage between 0V and +0.76V that is buffered by the op-amp. As the B input is AC coupled this DC voltage cannot be directly used into input B, but must be connected to a point where DC restoration has been used, in this case the junction of R17 and IC2, pin 1. Note that if fading or wiping to input B is to be used, then this circuit cannot be used.

An interesting effect is to set the fade control to half, and the shade to white, this gives the effect of peering through fog, although the usefulness of this function may be questioned.

Sideways wipe

Figure 6c is a sideways wiper. This operates by using a monostable triggered from the rising edge of the line data valid signal to produce a pulse, which switches off the video signal during the line. The period of the monostable is controlled by the potentiometer, and the output of the monostable drives the force B input of the sync board. By using either the true or the inverted output, the wipe can be forced from the left or the right of the screen.

Note that the functions of figure 6c, 6d and 6e all drive the force B input to switch the video signal. To achieve this a simple diode OR circuit is used.

Up/down wipe

Figure 6d is the up/down wiper control that operates in the same way as Figure 6c, however it operates from the field data valid signal and has a time constant which is much longer than the sideways wiper of frame length. Note that the on/off signal may occur during a line, and therefore the vertical fader may switch during a line causing a partial line to be displayed at the boundary of the wiped area. This is very unlikely to be noticed, but if it is thought to be a problem then the output should be re-timed by a flip flop (e.g. HC74) triggered by the line data valid signal to ensure that switching only occurs at the beginning of a line. The full function digitally controlled mixer to be presented in the next article uses this technique.

Video on/off

This simple switch function provides a direct on/off control for the video.

Components

Resistors All 1% 0.25 watt

R1, 2, 7	75R
R3, 4, 5, 6	1K
R8, 9, 10	10K
R12, 14	56K
R15	680K
R16, 17	430K
VR1, 2, 3, 4	22K horizontal preset

Capacitors

C1,8-10,14-16,18-20	0.1 μ F disc ceramic
C2, 4	1nF disc ceramic
C3, 5	1 μ F 10V radial electrolytic
C6, 7, 12, 13	10 μ F 25V radial electrolytic

Semiconductors

IC1	EL2244
IC 2	EL4095
IC 3	EL4581
IC 4	78L05
IC 5	79L05
IC 6,7	74HC123
IC 8	74HC00
IC 9	74HC4066

Miscellaneous

PL1,2,3	PCB mounted phono sockets
PL4	16 way 0.1 in IDC header
Veropins, 2 x DIL 8 pin IC sockets, 3 x DIL 4 pin IC sockets, 2 x DIL 16 pin IC sockets. All parts are available from Maplin and other regular suppliers.	

The SCART socket

The SCART socket (also known as a Peritel socket) is now widely supported on video equipment, particularly in Europe. The diagram shows the layout looking down into the socket. The socket is normally 21-pin, although the final pin is usually formed from the body of the connector, which forms a safety ground. All the projects in this series can be interfaced via a SCART connector, although for convenience they are all shown with phono sockets.

The pinout depends on the specific functions implemented, however certain pins such as audio and composite video are present in all

implementations. For any project in this series with most videos and TV sets, pins 1, 2, 3, 4 and 6 will provide audio in and out, and pins 17, 19, and 20 will provide video input and output.

The table below shows the SCART pinouts, note that where a pin is not designated as input or output (e.g. Blue) then it is usually an output on one device, and an input on another. Where a pin has more than one function dependant on function then these are shown in the description column. The most common function is shown first in each case.

Pin	Signal level	Impedance	Description
1	0.5V	less than 1K	Audio mono out Audio right out
2	0.5V	more than 10K	Audio mono in Audio right in
3	0.5V	less than 1 K	Audio mono out Audio left out
4	0V	more than 10K	Audio ground
5	0V		Blue ground
6	0.5V	more than 10K	Audio mono in Audio left in
7	0.7V	75R	Blue in/out
8	Digital		Function select HD status in/out
9	Ground		Green ground
10	Digital		Data (2)
11	0.7V	75R	Green in/out
12	Digital		Data (1) HD vsync in/out
13	0V		Red ground
14	0V		Data ground
15	0.7V	75R	Red in/out
16	Digital		Chrominance video in/out RGB Control (High = RGB, Low = Composite) HD hsync in/out
17	0V		Videoground
18	0V		RGB control ground
19	1V	75R	Composite video out
20	1V	75R	Composite video in
21	0V		Luminance video in/out Safety ground

Fig 9. The SCART connector

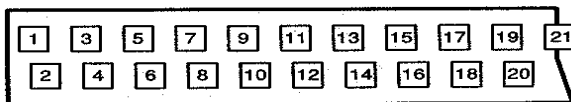

The S-Video Connector

This type of connector is a 4 pin mini DIN plug. The composite video signal comprises the brightness signal (luminance) with the colour signals (chrominance) modulated on a 4.433 MHz sub carrier. The operation of modulating the colour signal onto the composite video signal and then demodulating introduces noise. In addition to this high frequency, variations in the brightness signal can create false colour signals (the effect can commonly be seen on small checked jackets on TV pictures).

To carry high quality video signals such as those recorded on hi-band camcorders the S video connector is used. On this type of connector the Y signal contains the brightness information with no colour burst, and no colour information, the C signal contains the colour information. This also allows the Y signal to have a higher bandwidth than in a composite video signal, and more detail is available. It is notable that the eye can detect detail in the brightness domain with greater detail than colour, therefore increasing the bandwidth of only the Y signal gives the illusion of an overall increase in bandwidth.

The pinout of the S-Video connector:

Pin	Function
1	Luminance Ground
2	Chrominance Ground
3	Luminance (Y)
4	Chrominance (C)

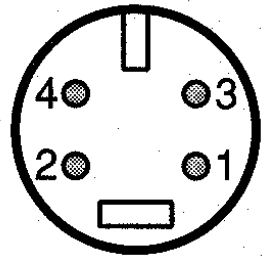

Next time.

In the next article, we will look at using the sync board in a full function digitally controlled fader/wiper, which can be controlled from a PC, or from a keypad.

Note: We have made some crucial modifications that make material improvements to the performance of its operation. ED

ETI is available every 4 weeks from all leading newsagents. Subscription enquires: 01858 435344.- ED

Circuit Notebook No.62

By John Lawrence GW3JGA

Off-Air Frequency Standard

This useful little circuit is a cut down version of a design by DK2DB that appeared in the RSGB Microwave Newsletter of January 1996.

As you know, there are several Standard Frequency Transmissions available in the UK, e.g. Radio 4 Droitwich on 198 kHz and MSF Rugby on 60 kHz from which more useful frequencies can be derived. The method is usually based on a crystal oscillator, typically 10MHz, the output from which is divided down and compared in frequency and phase with the received signal. Any error produces a voltage that is applied to a varicap diode in the oscillator to control and 'lock' the frequency.

In recent years the timing (and thus the frequency) of broadcast television waveforms has been derived from atomic and national standards and as such the waveforms may be used as Standard Frequency Transmissions. The attraction is that the reception and extraction of the television timing waveform is relatively simple, all that is required is a TV receiver with a video output, e.g. pin 19 on the SCART connector with pin 17 to GND. This signal is then connected to the circuit to be described.

The circuit is shown in Fig. 1. The broadcast composite video signal is applied at the input of the sync separator IC1 that extracts the sync signals. IC2 is a monostable which effectively removes the twice line pulses of the field sync signal and provides a clean square-wave output at the line timing of 64µs, i.e. a frequency of 15.625 kHz. Moving now to the 10 MHz crystal oscillator powered by IC4a. The output from this is buffered by IC4b and fed to the divider chain, IC5 (div. by 64) and IC6 (div. by 10) giving a total division of 640.

The resultant output is $10\text{MHz}/640 = 15.625\text{ kHz}$.

The square-wave outputs from IC6 and IC2 are fed to the phase comparator section of IC3. The output from IC3 is a square-wave of variable mark-space ratio, the ratio being directly related to the phase difference between the two inputs. This signal, when filtered provides a D.C. level directly related to the phase difference. This voltage is applied to the varicap diode to pull the oscillator frequency until the phase difference between the two signals remains stable. Under these conditions the 10 MHz oscillator is phase-locked to the incoming TV synchronising waveform and remains so.

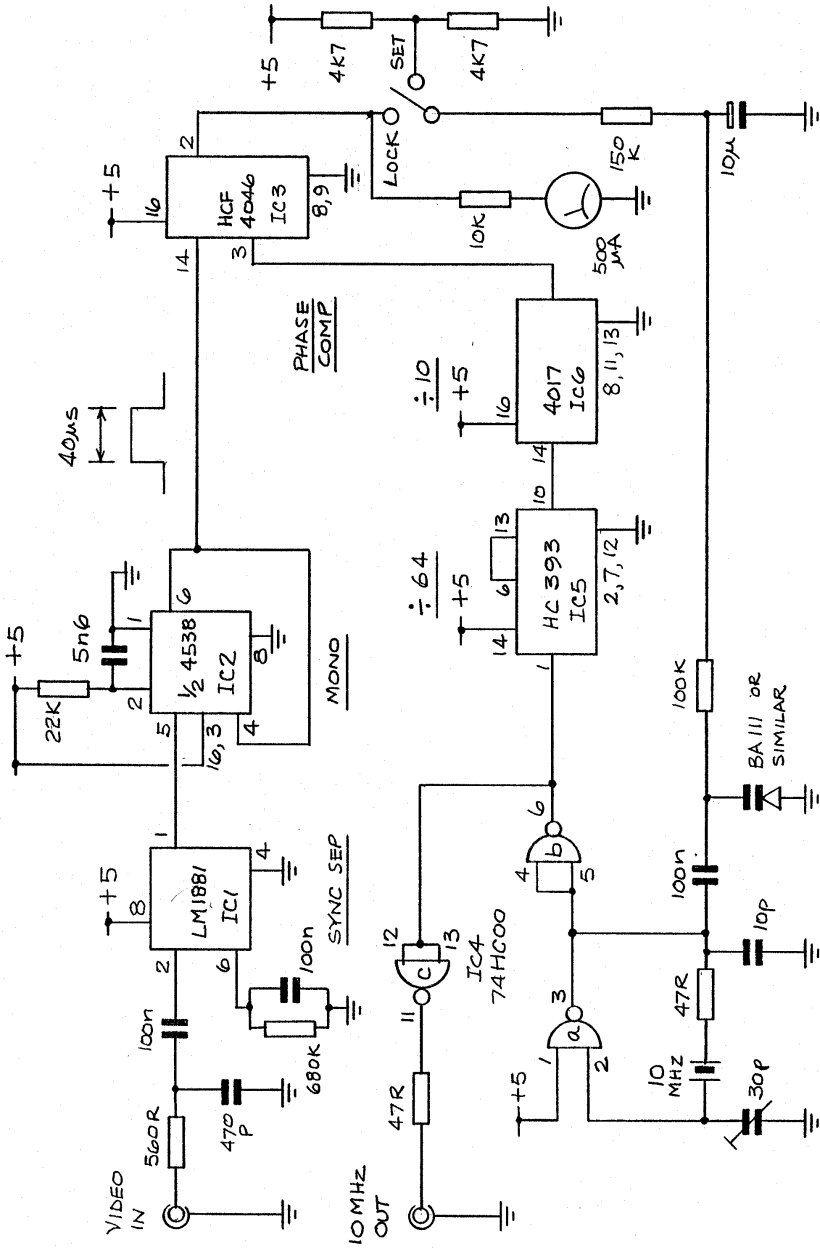
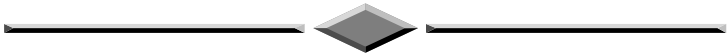

Fig. 1. TV Off-Air Frequency Standard

To set up the circuit, put the switch to 'set' and adjust the trimmer capacitor until the beating indicated by the meter slows down and settles to half scale reading. Switching to the 'lock' position completes the loop and the oscillator is then phase-locked. I built my prototype on a Maplin 'Plugblock' keeping the oscillator wiring reasonably short.

The long-term stability approaches that of the transmission but there is always the possibility of phase glitches in the waveform at the transmitter causing small disturbances. The short-term stability is quite adequate for checking your frequency counter up to about 7 or 8 digits. Some frequency counters have provision for injecting a 10 MHz external source and the circuit would be suitable for this purpose. It is reported that BBC1 is probably the most stable transmission to use.

Reference: RSGB Microwave Newsletter January and March 1996.



Paul's Iconoscope camera and monitors at the IBC

Subscription Renewals.

By Dave Lawton, Membership Secretary

Since the Club was founded the subscription has run from 1st January till 31st December. During the latter part of 1996 we introduced a change that meant that for new members subscriptions run for twelve months from the date of joining. This was to simplify the membership administration.

However for the majority of members their subscription will fall due on the 1st of January and hence this subscription reminder. The software that prints the CQ-TV labels has been modified such that if your subscription will fall due before the next magazine



your address label will indicate that fact and state “subs due”. This will also apply to our newer members who joined during the year.

In all cases when a label is printed with “Subs due”, we will enclose a subscription renewal form with the magazine.

The subscription for 1998 remains the same as last year at **£12.00** and as usual, we offer discounts for renewing for more than one year as detailed below.

1998 only £12.00	1998 + 1999 - £22.00
1998 + 1999 + 2000 - £32.00	1998 + 99 + 2000 + 2001 - £40.00

Overseas Members, outside Europe, will receive their magazine by Surface mail. If anyone wishes his or her magazine sent by Airmail the additional cost is **£6.00** per year.

This figure reflects the additional cost to the Club to send magazines by air. Please note that there is no additional airmail charge to Members within the EEC and Europe.

Open Video Festival

By Yoel

The idea behind the festival is the simplicity and relatively low cost of video production. The desire to express oneself, to express an opinion, and to present a picture of one's personal emotional life need not necessarily be the exclusive preserve of one part of the population. Experience and professional competence might lead to a more polished result or interpretation, but not necessarily a more truthful picture of reality.

We start from the assumption that we are at the beginning of an age where audio-visual products are becoming cheaper and cheaper, enabling more and more people to express themselves by these means.

We regard the democratisation of the media as of very great value and worthy of the attention and support of elements and groups concerned with freedom of speech and opinion.

Parallel to obtaining help and support in acquiring equipment and means of production, we need to strengthen existing networks and build new ones for the presentation of the product to a broad audience.

The spirit of the films should be fresh and original - placing a premium on vividness of expression rather than on the clarity of the picture.

The initiator and producer of the happening is the CAC co-op - an organisation whose aim is the promotion and encouragement of interaction between the community and the media. The co-op combines artistic activity, video and computers as means of transmitting messages, opinions, and works of art inside the community and between different communities.

C.A.C Co-op - Background

In the last few years we have witnessed a process of multiplication of TV channels and means of communication. However, sadly enough, this process did not bring about the multiplication of opinion or diversity. The subjection of the media to the laws of commercialism and the desire for high ratings created a general mediocrity, and excluded sections of society and opinion outside the mainstream. Therefore, there is a need for a non-commercial network that will satisfy those parts of society, which are not represented in the present system.

Open Video Festival

A network which will support non-commercial projects which have no hope of obtaining high ratings. We consider this of the highest value for the democratisation of mass media.

We conceive of the media as an open system which should include non-professional people, as opposed to the polished and professional we stand for the honest, direct, rough and low-budget. Our work is intended to answer needs on two levels: the first is the level of the individual and the intimate, personal products that convey information, experience, views of life and personal experiences in the audio-visual language. The second level is intended to answer the different needs and to connect members of communities that differ one from another in character and geographical location. These are the needs which CAC was established to meet. The CAC co-op (Community, Art, Communication) was founded in 1997 by a group whose members come mainly from the fields of art, video, computers, etc. The co-op is a non-profit organisation run by its members democratically, to promote and develop the ideas for which it was founded. The profits from its activities are reinvested in initiating and encouraging additional activities. The co-op uses the media - video, Internet, etc. and combines a progressive social approach, humanistic and democratic, to promote its goals.

Goals of the Co-op

Support and encouragement of artistic projects, video and internet, which have no commercial potential. Building and supporting projects which involve the media as the means of creating connections between communities inside the country and abroad. Support for experimental projects intended to investigate and inquire into audio-visual language. The humanisation and democratisation of contemporary and future technologies. Support for the integration of the media at all levels of the education system. Giving expression to sectors of society which have minimal access to the means of the mass media. Creating and supporting projects which combine different age groups and cross-sections of society. The co-op will work to create a physical network in existing centres and centres still to be established in order to promote the above projects. The co-op will aspire to obtain maximum co-operation with relevant institutions and organisations - municipalities, local councils, community centres, public bodies, similar co-ops, commercial organisations, etc.

Shalom Yoel. e-mail - mox2@actcom.co.il

*(There is more information on this Festival on page **Error! Bookmark not defined.** – ED)*

PIC Dream

By Alain Fort

Programmable Intelligent Circuit Dedicated to Radio and Electronic Amateurs, Mainly (Ouf !!)

Here is the first version of a video PIC system with :

A 7 scrolling 5*7 characters message in the top of screen

1. Grey scale bars in the middle.

2. A real time clock in the bottom.

I wrote this program for all TV radio amateurs, looking for a low cost video generator.

Thanks a lot to Peter Knight's original 4 MHz synchronisation routines. Thanks to the British Amateur TV Club for its good pages on the PIC which decided me to use the PIC, to build my own programmer and write this little program.

I wrote all character routines to get real 5*7 characters à 1 MHz with a 7 characters scrolling display, designed the clock routines and the grey bars and clock set-up routines.

The PIC16C84 uses a 5V power supply and a 4 MHz crystal oscillator. Using this code is free for amateurs.

Mail: Alain Fort, 8 rue G. Péri, 78420 , Carrières sur Seine, France

France Phone: 0139577678

World phone: 33 1 39577678

Packet radio: F1CJN@F6KBF.FRPA

Email: Tristan@Club-internet.fr

Note: The complete assembler listing, a HEX listing, and an ASCII text version of this article is available for download from our web site. The file is called PICDREAM.ZIP and is 18k bytes long.

Point your browser at <http://www.batc.org.uk/software.htm>

The circuit diagram for this project is shown below.

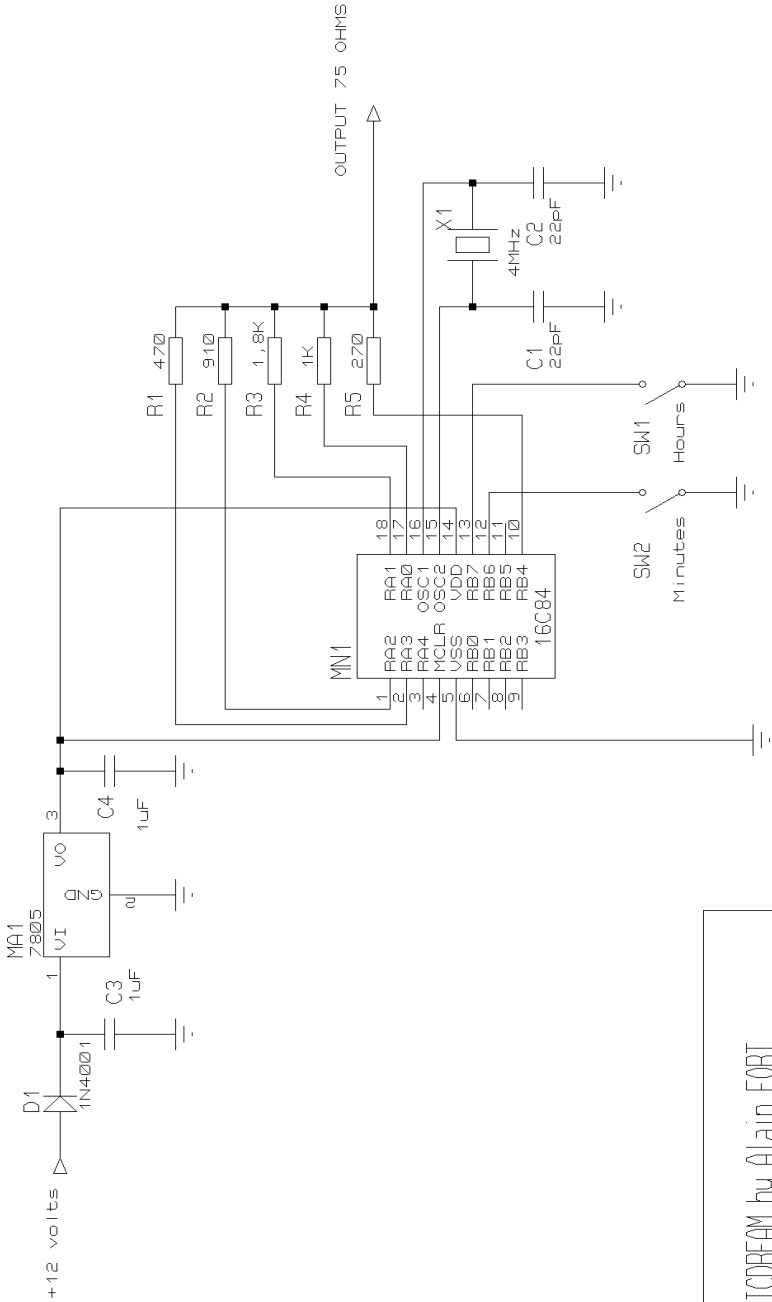

PICDREAM by Alain FORT

21/06/1997

First Passed the Tape.

Dicky Howett uncovers the magnetic world of videotape restoration.

Imagine you've just discovered this strange videotape. It's not Beta, VHS, Hi8, or any current format. The box reads 'Akai VT 100'. It's a puzzle. The tape looks in good condition, but you need to replay it because, rumour has it, the tape contains a unique performance by rock legend David Bowie and his production company is keen to offer you vast sums in order to issue it on a sell-through video.

The solution would appear simple. Find an Akai VT 100 videotape machine and transfer the tape without delay.

The above was a genuine case history and the Bowie tape was successfully transferred. The process seemed easy, but the solution can be much less straightforward.

As is now well known video tape (and all recording tape) has built-in problems. The older it gets the more capricious it becomes. The urge to self-destruct is manifest. Additionally, videotape tends to exhibit useful little by-products such as cinching, flaking oxide, leaking lubricant, deformation and dropouts.

Historically, videotape didn't just pop into the world as a fully formed and immutable product. Many hands gave it birth and many techniques were employed to get it up and running. The first video tape recorder was publicly demonstrated in 1951. This system was produced by the Bing Crosby Laboratories. The tape ran at 254cm per second and the total recording time was 16 minutes per reel. Picture quality was poor.

The BBC too were experimenting. In 1952 they built prototypes of a fixed-head machine called V.E.R.A. (Vision Electronic Recording Apparatus). This monstrous piece of kit had tape rushing by at 30ft per second! Unfortunately, picture quality was worse than the old style film recording, which this tape system was supposed to replace. Later, in 1956 the US Ampex Corporation with a team headed by Charles Ginsburg and Ray Dolby, achieved the breakthrough by using a revolving scanning head and a much slower tape speed. Their machine, the Ampex VR1000 became the standard broadcast recording medium. The Ampex had four recording heads fixed on a transverse drum, revolving in a vacuum. This Quadruplex system used 2" wide tape. However, early tape technology coupled with brutal head contact caused considerable wear on both tape and recording heads. Also the first machines had no erase heads. But the system was a hit and in 1958, both Associated Rediffusion and the BBC began to use videotape as a serious production tool.

First Passed the Tape.

Since then, the medium has proliferated as much as the message. Different recording systems, all incompatible continue to hamper the broadcasters and archivists. These days, tv companies are very keen to recover their video past. Programme material of any sort and from any source is a potential gold mine.



An Ampex VR 2000 Quad machine

Still refining the ore is the Great Auntie of all archives, the BBC FILM AND VIDEO TAPE LIBRARY down at Windmill Road, Brentford. Established as a permanent archive in 1981 (the BBC had no mandate to preserve programmes before that date), the Library is now accumulating VT material at the rate of approximately 100,000 items per annum. Also, the BBC is actively hunting for old programme tapes (and films) in any format. The days of (alleged) indiscriminate programme destruction are long gone. Destroying Dr Who or Dixon of Dock Green on the basis that it was 'only' in black and white is an aspect of the BBC's archive practise best forgotten, although the spectre still haunts. Fortunately, a number of BBC programmes were recorded for export and it is from that source that legendary 'lost' shows have returned. Also, private videotapes have since saved the BBC's archival bacon, with some episodes, notably of 'Steptoe and Son' returning to swell the Corporation's back catalogue.

Today every tape is scrutinised and assessed (all news footage is automatically preserved including the cuts). Once in the archive videotapes are stored upright and in a controlled temperature of 70F. The BBC's TV Archivist Christine Slattery elaborates. "We hold seven vt formats in the Library; 2", 1", Umatic, Betacam, Digital Betacam, VHS and Philips. We still hold 25,000 2" Quad tapes that continue to be transferred to D3 by BBC Post Production who successfully tendered for the task. We started transferring to digital in 1993. Our recent discoveries include two episodes from an early BBC colour drama called 'Nana' which was transmitted in 1968. Also, 'Hassan' from 1971 featuring Sir John Gielgud, Ralph Richardson and Nyree Dawn Porter. One benefit of converting to D3 digital is that more space is released for archive storage. As tape formats reduce physically, we gain more shelves and racks."



Transferring archive tape at the BBC's Film and VT Library

It's not only the BBC who are on the lookout for long lost plays, comedy programmes or sporting events. All broadcasters and many institutions such as hospitals and universities have now increasing archive requirements. Fortunately, recordings are still surfacing from basements, cupboards, lofts and boot-sales. They are still out there somewhere, spools, cassettes and canisters, full of precious images captured when videotape technology was young. But transferring these vt riches requires special vt

recovery techniques. It's not a task for the fainthearted or the inexperienced. Fortunately, there are a few dedicated commercial organisations who will gladly handle any old sort of videotape.

THE VIDEO ARK down at Ealing is owned by Lucy Reeve. She's an experienced ex-BBC television recording engineer. Also, she has probably the world's largest collection of video machines and formats. These include Philips 1500,1700 and V2000. Grundig SVR. IVC 1" midband helical scan. IVC 9000. Quad 2" 405, 525, 625 and 819 lines. Lucy Reeve, "I must admit that the physical act of tape restoration and recovery is extremely tedious. Boring even. VT rescue needs skills that frankly aren't really there any more. It's now up to people like myself to rescue the world's videotapes. I get orders from France, Germany, and America. Recently, I copied from 1" 'A' format a 1971 Sir Frederick Ashton Gala Performance for the Royal Ballet Archive. Also some material for a project on Rudolf Nureyev, which involved 2" quad, ½ inch, open reel and even Super 8. As a recording engineer I have the expertise in all these areas. I've even handled 9.5mm film for 'The South Bank Show'".

THE VIDEO LAB is based at St Anne's on Sea, Lancs. Chief Engineer Donald Blakely expounds, "We've been around for 35 years. We buy unused spares and secondhand equipment, which our engineers carefully restore. We also construct video machines from scratch. Recently, we had a request from the Andy Warhol Museum to recover and transfer, twenty of his 'art' videotapes worth an estimated £12 million. For this we had to first carefully examine the tapes, identify the method of recording and then build a player. We were successful. Most of our transfers are onto Beta SP but increasingly we are using digital techniques. For Channel Four we used D2. We also handle tapes for corporate bodies like County Councils and Hospitals. Quite a few recordings of operations have been successfully rescued."

PMF VIDEO LTD are in Goldhawk Road, London. They specialise in 2" quad. MD Paul Farnsworth, "I reckon that VT operators under 35 years of age have never even handled 2" quad." Paul adds, "This is why broadcasters leave this sort of work to us. We have the time and expertise and we get results. London Weekend Television was having a problem with transferring their 2" library. They were only getting a few bits and a few hours per week. We offered to give them a 100 hours for a 100 hours.

That did the trick. We've now copied several thousand hours of their library onto Digi-Beta. The same with ITV Sport. Recently it was 200 hours for them. All that might have been lost forever. We Recortec clean the tapes but there's still the problem of hydroscopic breakdown where the polyester backing of the tape starts to resemble Sellotape causing 'Stiction'."

Paul Farnsworth points out that 2" quad machines are very rare now. Also increasingly, fewer people know how to properly operate them. "I am quad experienced. We have two RCA TR600's and an Ampex VR2000, a very forgiving machine that can be tweaked to retain sync, especially when transferring non-standard or badly recorded material. Although most of the 2" quad broadcast tapes have now been accounted for, there's still a lot of archive work around."



VT tape editing the easy way! Just find the pulses with a microscope and cut with a sharp object. This is the Smith's 'Micro 40' hi-tech VT editing machine from the 1960's

Second-hand video machines clearly have a role in the process of recovery and preservation. So think twice before scrapping that old piece of vt kit or chucking that funny reel into the bin. It might have a whole new life beyond broadcast specification. Take heed. The experts are out there now waiting for your call. If its video, you can bet that somebody, somewhere has probably got it all taped.

Flat Plate Aerial

By John Stockley, G8MNY

This is a simplified design for /P aerials yet offers about a +12dBd gain over the whole 23/24cm band or it can be centred on 23 or 24cm (*) ends of the band.

A detailed design can be found in UHF Compendium, but I have found simpler constructions work just as well, and on tests are better than some of the ATV long yagis on offer!

The high gain is explained if one considers each full wave length loop to have the gain of 2 dipoles = +3dBd, thus 2 loops = +6dBd so doubling again the 4 loops = +9dBd, and with a perfect reflector you get +12dBd, which is 12.4dBi. In practice there are losses, but well constructed it will give +10dBd at least.

Figure '8' Elements

Two elements are constructed from mains 2.5mm cable with the inner insulation left on. Each compound element is bent into a figure of '8' from 2 wave lengths 2x 24.5cms (* 23/24) long (2x49cms for both leads), and equates to 4 dipoles (8 for both elements). The start and stop of the two 8s are at the top and bottom respectively, and the "8" centre cross over points are left insulated.

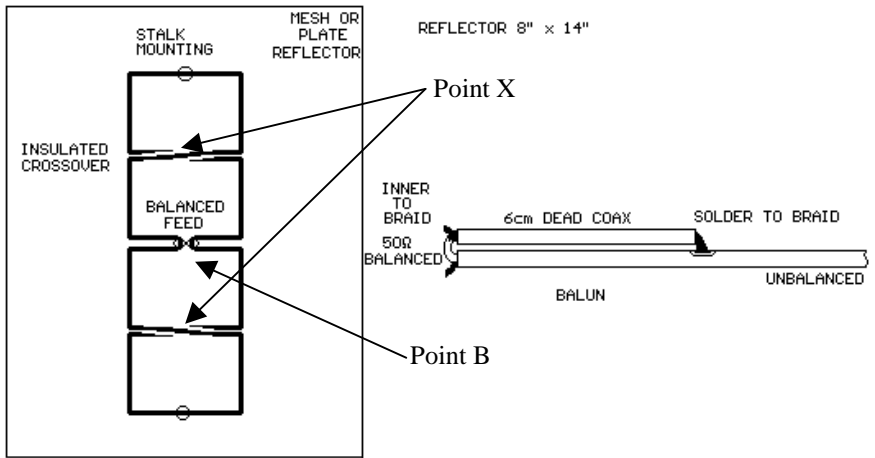

Reflector 8" x 14" nominal made from ally sheet foil on wood, or galvanised mesh with 1cm squares. Point x is the wire crossover point, actually not bent in, just alongside crossover. Wires can be glued or tied together for neatness.

The Balun is 6cms of scrap coax alongside the feeder. The feeder inner is connected to the dead coax braid. BB are the 50 ohm balanced feed points. The 2-coax balun can be glued into two holes in the reflector.

Stalk mountings can be made from UR67 inner insulation 1" long screwed into from the reflector side, slotted, and heat moulded to capture the wire.

SWR can be adjusted by the distance the 8's are from the reflector. As shown the aerial is horizontally polarised. The Polar diagram is 90deg coverage but very tightly pointed at the horizon (stacked array gain).

Higher gain can be had by stacking and baying 2, 4 or more aerials, provided they are all mounted flat to each other and the reflectors (one sheet?) do not overlap. Identical feeder lengths and matching the aerial array then becomes a problem.

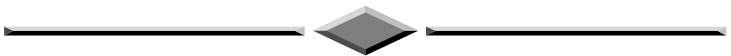

A different view of the BATC stand at IBC

Post and News

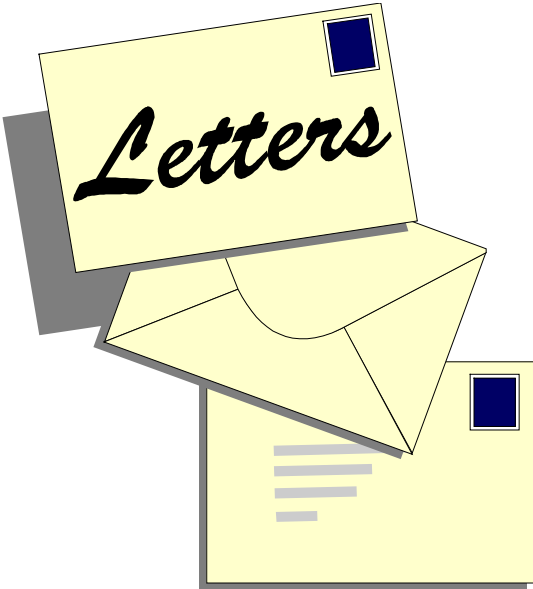

Please send all correspondence for **Post and News** to the CQ-TV Editor. Ian Pawson, 14 Lilac Avenue, Leicester, LE5 1FN, England.

Tel: 0116 276 9425.

E-mail editor@batc.org.uk

Members sales and wants, and trade adverts should be sent to the advertising manager,

Dave Hemingway, Ivanhoe, Glen Road, Hindhead, Surrey, GU26 6QE. Tel: 01428 604645

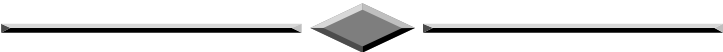

Email

The following items were plucked from the Internet or sent to me directly as email.

If you have any snippets of news of information, then please send them in to my mailbox.

[Last update 04/15/97 0947]

WELCOME TO THE TALLAHASSEE
ON-LINE AMATEUR TELEVISION



DISCUSSION MAILING LIST

Greetings ATV operators, NEWS from Auckland.

The ZL1BQ ATV repeater is back in operation after a three month closedown for building renovations.

A new, 50cm (615.25 MHz), output amplifier using a BLV59 device (costing \$400 for the dual transistor) is now in use. The output power is now 10 Watts average.

The 70cm receiver is now equipped with an additional (5.74 MHz) subcarrier demodulator for stereo operation to the German/Australian system with the appropriate pilot tones.

The beacon mode has two subcarriers (5.5/5.74 MHz) and has a separate tone modulation on each. This is NOT in stereo at this stage, as a beacon. Only if a stereo sig is transmitted from a 70cm station with appropriate subtone, is the repeated transmission truly stereo.

DTMF switching, for North or South 70cm receiving aerials, is provided by a 2M receiver at the ATV repeater tuned to 147.450 MHz (an NZART approved frequency for auxiliary ATV use).

16 pages of text messages alternate with a ZL1BQ colour test card about every ten minutes in the beacon mode. An audio tone is transmitted too.

Micro control is used for the general switching operations and control.

73, Michael Sheffield ZL1ABS, 176 Albany Highway, Albany, Auckland, NZ 1331. Email: zl1abs@xtra.co.

Re: Open Video Festival - Jerusalem, Tel - Aviv, Haifa. Jan. '98

The festival will be open to all entrants in all non-professional video formats VHS, S-VHS, DV and Hi8. The festival will take place in all three cinematheques, Jerusalem, Tel Aviv and Haifa. Besides showing the short films there will be panels and discussions on communication, communication and democracy, communication and community, the use of the media for internal and external communication in the community, etc. In addition works of art and installation will be exhibited.

We are approaching various video workshops, festivals, organizations and co-ops with a view to obtaining materials in their possession. We are mainly interested in short, low-budget video films, home videos, experimental, animation, documentaries, dramas, video art, etc. We will be glad to receive information from you in this matter. *(See the article on page **Error! Bookmark not defined.** ED)*

Thanking you in advance, Shlomo Yoel. E-Mail - mox2@actcom.co.il

From:W3HMS@aol.com

Subject: NAATA Progress To Date.

“CAATN supports the fondation of an Amateur Television Organization for North America” by John Jaminet, W3HMS, 912 Robert St.,Mechanicsburg, PA 17055 USA, EMAIL W3HMS@aol.com

I am pleased to report that the CAATN, Central Atlantic Amateur Television Association, at its regularly scheduled quarterly meeting in York, PA on 16 August 1997 has voted \$50.00 as the seed money to support the foundation of the North American ATV Organization. In addition, the members individually put their seal of approval on the organization by putting \$6 in the hat passed by our Treasurer, Harry, N3KYR. So we have now \$113.00 to support the administrative expenses of postage, copying et al to get the organization going.

I am pleased to announce that 7 of the 10 Implementation Committee Members as of today are:

1. Fred Juch N5JXO Houston,TX of HATS juch@flash.net
2. Bob Stone W3EFG Daytona Beach, FL ATV Repeater. robertstone@juno.com
3. Art Towslee WA8RMC Columbus,OH of Columbus Group New address needed.
4. Jim Tury KA4CKI Virginia, Pres. Metrovision tury@erols.com
5. John Jaminet W3HMS Mechanicsburg,Pa, CAATN Vice Pres. w3hms@aol.com
6. Ron Cohen K3ZKO Cheltham, PA, CAATN President ronk3zko@juno.com
7. John Shaffer W3SST York,PA Editor CAATN Bulletin w3sst@juno.com

As to background, as indicated in my ATVQ article in the Spring 1997 edition, the inspiration for this organization was my (W3HMS) visit to the French national ATV society meeting 9 Nov 1996 at Tours, France.

The nucleus members of our new society are communicating by INTERNET EMAIL for the founding and will thereafter. ATVers are now dependant on some magazine editor/company/club to host the ATVers meeting at the Dayton Hamfest.

We should have a national organization to do it.

For background information, see the proposal written by W3HMS in the Spring 1997 ATVQ and EMAILS of 3 July 1997 on this List.

We need three more Implementation Committee Members. The qualification for IC members:

- a. Interested in serving.
- b. Capable of communicating with other IC members 2-3 times each week via Internet EMAIL
- c. Capable of representing the needs of ATVers.

We resent the IC Call message on 25 July 1997 and we added:

“Due to the summer vacation schedule, we want to give a bit more time for the nominations per the attached file. Please pass this message far and wide and inform all that the date is extended to 1 Sep 97 and beyond.

ACTION...What can you do to help.

If you know someone who should work with us in building this organization, please have them send an EMAIL to:

Ron Cohen, K3ZKO, EMAIL:ronk3zko@juno.com

John Jaminet, W3HMS, EMAIL:W3HMS@aol.com

John Shaffer,W3SST, EMAIL:W3SST@juno.com =

73 de John, W3HMS

Andrew Emmerson/Midshires Mediatech/405 Alive, tel: 01604-844130, international +44 1604-844130 fax: 01604-821647, international +44 1604-821647

RCS Radio Pty Ltd, 651 Forest Road, Bexley, 2207, NSW, Australia

Tel +61 2 9587-3491 +61 2 Fax 9587-5385, Robert J. Barnes.

Our email is checked @ 7.30am and 7.30pm daily, thank you. Check out our home page on <http://www.cia.com.au/rcsradio/>

Please see CQ-TV 179 page 82, A Video AGC update. RCS sullpy the PCB for this project. ED

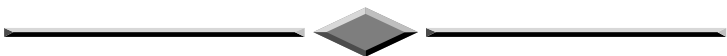

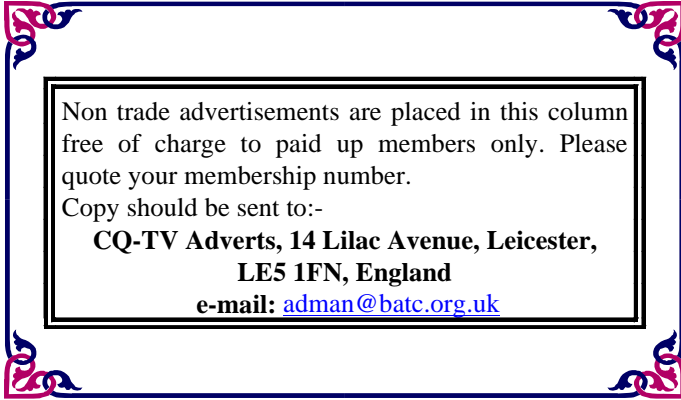

For Sale

FOR SALE: Shibaden SV-700 open-reel video recorder with 140 reels of tape, all recorded. *Contact Gordon Tew, Chard, Somerset; telephone 01460-64376.*

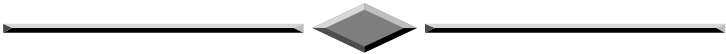

LaserVision VLP 600. Its condition is unknown, but believed to be complete and working. I do not have any disks for it. *Contact Alan Strong, G3WXI 01 759 388172 (NOT QTHR)*

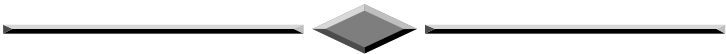

For Sale. Fortop 70cm t.v.t 435 T.V.Tx and TVD 100 demodulator. Also Microwave Modules Rx Converter. 16 Element 70 cm Antenna, and Tokyo 430 meg Gasfet Mast Head Amp. HRA7 with home brew 30amp 15v power pack - any offers *G3TQE Alan 0121-783-6822*

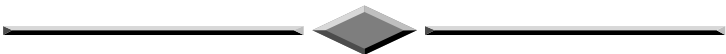

BARCO projection TV spares. Lenses, PCB's, LOPT's tubes, yokes, remote controls, PSU's, eht's, rgb input and convergence boards, some new bits but mostly from stripped down units.

Amstrad SRX200, skyscan and similar satellite receivers £10.00 each. LNB's from £5.00 useful for ATV rx conversions. Videocript decoders £10.00. **Contact Trevor Wiltshire, G8AKA, Reading 01189 701163.**

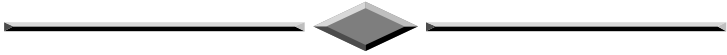

Betamax VCR Alignment kit with jigs, gauges, test tapes etc., VCR tapes (used) Betamax, Philips 2000 and the odd 1500. Pye 14" Studio Monitor. Thorn TV receiver WJ13 405/625. Marconi camera chassis No. 6276b. Early TV and Radio books. Radio and TV service sheets. SAE for list. **Contact B. Alderson G3KJX, 43, Brompton Rd., Northallerton DL6 1ED Tel. 01609 772702.**

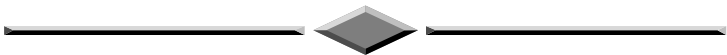

Bound set of good quality photocopies of CQ-TV magazines Nos. 1 to 120. Complete except for two pages! Two sided copies are adjusted to fit 8.5" x 11" paper and bound in 9 volumes with white Cerlox plastic spines in light blue covers. Bound with title sheets in 9 volumes 1-20, 21-40, 41-60, then every 10. Total height about seven inches Say 1500 sheets, weight 16 pounds. I will let these go for cost of paper and shipping.. Offers please to **Arthur W. Critchley, 6, Abercorn Rd., Markham, Ontario Canada. L3P1V3 Tel. 905 294 6797 or tel/fax 905 472 9106**

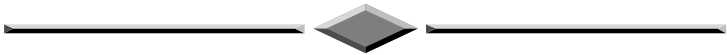

U-Matic edit suites. Two complete JVC low band suites each comprising CR8200, CR6600, RM88 c/w all cables and manuals. All in good order. £250 per suite or 400 the lot.

Panasonic F10 single chip CCD colour cameras. With zoom lens, genlock adapter, cables, manuals. Good working order. 3 available at £200 each. Possible 4th complete camera (slight mechanical damage) and spare genlock adapter.

Vital VIX-114 10 input vision mixer. Complete rack, PSU, control panel, cables, manuals. Circa 1980 vintage. Will need some attention (the electrolytics die!) but is basically a decent unit with good wipes, keying etc. £35 ono.

Various TV/stage lighting fittings. Condition varies from excellent to grotty. Prices negotiable: 5 off Berkey 2136 cyclorama lights 3 off 500W Strand Scoops (Historic!) Assorted fresnels Various bits including audio

cable, multicore cable, control panels, BBC AM4/517 series VDAs etc etc. Not worth a special journey or cataloguing but can be viewed with other equipment. Prices very negotiable.

All equipment can be viewed by appointment in London NW5 London or (especially for smaller parts) at my home in Oxford.. **Contact:- Jeffrey Borinsky Phone: +44 (0)1865 777534 Fax: +44 (0)1865 749540 E-mail: jeffrey@borinsky.demon.co.uk**

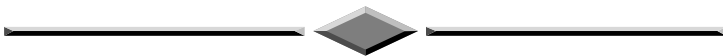

TELEVISION JUBILEE The story of 25 years of BBC Television. Gordon Ross. W.H. Allen 1961. Illustrated. VGC £8.

ATV SHOW BOOK. 1960. Lots of pictures of ATV shows. VGC £6.

BBC AND ALL THAT. Roger Eckersley. Autobiography Sampson Low. 1946. D/w VGC £5.

SCHOOL BROADCASTING IN BRITAIN. BBC 1947. Illus. D/w VGC £3. GIRL Film & TV Annual No.1 1957. No d/w Boards slightly stained VGC £5. GIRL Film & TV Annual No.5 1962. D/w slightly torn at top. Article on outside broadcasts. VGC £6.

HISTORY OF TELEVISION. Rick Marschall. 1986. Large format US picture book. Many illustrations. VGC £6.

WONDER OF THE WAVES. Eduard Rhein. 1940. The Scientific Book Club. Illustrated. Sections on Radio and TV. No d/w VGC £5.

Dr. Who Annual No. 1. VGC £8. Dr. Who Annual No. 2. VGC £8. Dr. Who Annual 1970. Troughton photo cover VGC £10. Dr. Who Annual 1971, 1973, 1974 (Pertwee Covers) VGC £5. each. All items clean and intact. Postage £1.00 per book.

Contact Dicky Howett Tel. 01245 441811 Fax. 01245 442816.

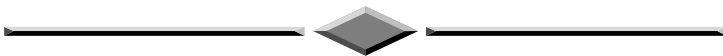

JayBeam 2 Metre Quad antenna, 6 ele. Jaybeam 2 Metre Crossed Yagi 10db gain with phasing harness. JayBeam 70cm Crossed Yagi 10db gain with phasing harness. 20ft aluminium pole thick gauge. Barenco tiltover wall mount.

Contact Tony Kempton G1BYS 0181 462 7051 after 18:00 or at work 0171 492 6046 07:00-16:00

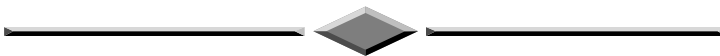

FOR SALE:

Vistek PAL Encoder 205P; Cox Teletext Decoder 495; Abekas-Cox Vision Switch VX164 (these are 1U-high 19" rackmount units). Electronic Visuals WFM and Vectorscope EV4020 and EV4040 mounted together as a single 3U-high 19" unit. Vistek Vector PAL/SECAM/NTSC and variants Standards Converter V4401 in 6U-high 19" rack unit. All obtained unwanted and untested as part of auction lot, quite clean and apparently complete. Buyer can have some odd spares too. Offers to Robert Field Bourne End (Bucks.) 01628-520138.

Andrew Emmerson/Midshires Mediatech/405 Alive, tel: 01604-844130, international +44 1604-844130, fax: 01604-821647, international +44 1604-821647

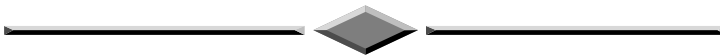

Wanted

I need circuit information for a 1204A television waveform generator made by System Video Limited.

Less desperately (because I fixed it) I also want information for the System Video Limited 1205 Vectorscope, Failing that, how about an address for System Video Limited? (The one on the back of the unit does not work.) **Tony Jaques, 88 Sandy Lane, Stretford, Manchester, E32 9BX. Telephone and fax: 0161 865 9398.**

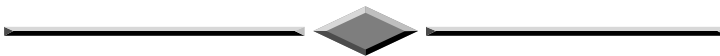

I am looking for average condition pre-war televisions. Will pay fair \$. Send description and price required to: **Lee Rhoden, 8906 Clayco Dr. , Dallas, TX 75243 or e-mail at main@seabrookcomputers.com**

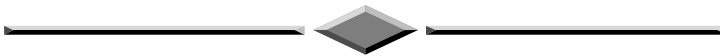

ARE YOU A HOARDER? Did you squirrel away a 3" image orthicon tube, which you never actually used? If so, may I buy it from you as standby for my camera (as seen in colour in last time's CQ-TV!)? Also looking for lenses for the Pye Mk 3 and a couple of Pye 2823 8.5" picture monitors. As ever, your price paid cheerfully. *Andy Emmerson, 71 Falcutt Way, Northampton, NN2 8PH (01604-844130).*

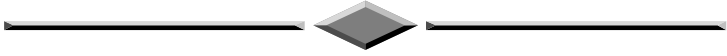

Wanted (to borrow) information booklet for the reel-to-reel UHER recorder model 4200 Report Stereo. *Tel: 0115 928 2896 (Doug Pitt)*

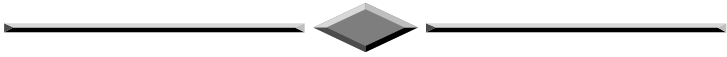

WANTED: Highly mobile TV transmitter engineers to work in Belgium, the Netherlands and south-west Germany. These are full-time salaried positions, offering a competitive salary. The job will appeal to ambitious, competent technicians and will provide excellent career experience for the right people, who will be motivated self-starters. The jobs, which involve 24-hour stand-by working, cover repairing satellite receivers as well as TV transmitters from 100mW to 2kW belonging to the US Forces. Vehicle provided, driving licence a must! Working language is English. Send resume if interested or apply for further information to

Peter Wood, Supervisor MSS, FSIC-OPMAS, Postfach 310142, D-68261 Mannheim, GERMANY. Tel: 00 49 621-730 3214, fax: 00 49 621-730 3689. E-mail: woodp@5SIGCMD.AMSF.ARMY.MIL

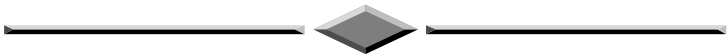

Wanted:- Umatic enthusiasts interested in exchanging information, mods, upgrades, spare suppliers, etc contact *John Hunter 01723 376174.*

Index of Advertisers

BATC web pages	24
GB3XT Kits & Bits - Bob Platts.....	12
Sevenside Television Group	33
VHF Communications	30
Worthing & Districe Video Repeater Group.....	23