

Lighting for Television and Film

By Peter Alan Johnson

Supervisory Lighting Director, Engineering
Manager, for Studio and Outside Broadcasts, retired



A foundation for lighting expertise

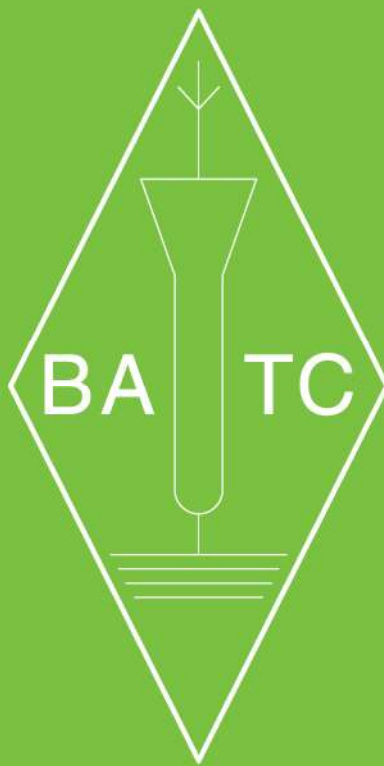

Supplied by the British Amateur Television Club

Visit our web site at www.batc.org.uk

Contents

Contents

Acknowledgments	9
Dedications	9
Introduction.....	10
The Qualities of light.....	10
The Objectives of Lighting	11
Tools of the profession.....	13
Familiarise yourself with each essential tool of this profession.	13
Light-meters for incident light.....	13
Colour meters.....	14
Spot meter (reflected light meter)	14
Monocle for looking into the lens of luminaires.....	14
Land Polaroid camera	15
Digital camera	15
Lighting stencils	15
Tape measure.....	15
A brief list of Luminaires used for television, film and theatre.....	15
North-lights	17
Mini brutes.....	17
Brutes.....	17
Compact source iodide	18
H.M.I. sources.....	18
Barn doors.....	19
Full flood and full spot	20
LOWEL omni kit.....	31
Croniecone.....	31
High key and low key	31
Fill light.....	35
Base light.....	36
Key lights	36
Modelling light.....	36
Eye lights or Kickers	37
Backlight	37
Top light.....	38
Set lights and Dressing lights	38
Overheads or Butterflies	38

Copyright. No part of this publication may be reproduced, stored in a retrieval system or transmitted in any form or by any means without the prior permission of the publishers, The British Amateur Television Club (BATC). © 2006 by Peter Johnson and the BATC.

Follow spots.....	38
The Super Trouper	39
Micro-Set	39
Coffins.....	39
Hancock Flicker free soft light	39
Flying Moon	40
Scrims	40
Diffusers	40
Lighting Stencil Instrument.....	41
Lighting Stencil Instrument to draw outlines of standard luminaires	41
How to use the Lighting Stencils 1 and 2	41
Lighting Stencil 2	43
How much incident light is required?	44
Introduction to lighting plots.....	47
The lighting plot (basic three point lighting plot)	47
Lighting Plot 1	50
Two Person Interview (dramatic interesting faces -crossed keys).....	50
Lighting Plot 4	52
Rear screen projection.....	52
Chroma key.....	53
Lighting people against a bright window	58
Gobos and flags.....	61
Cucolories or cukes or cut-outs.....	61
High Hats or funnels.....	61
Colour filters or gels (Heatproof and flame retardant).....	61
Umbrella soft lights used as main light source.....	61
White sheet Gobo lighting	62
Reflectors and reflected soft light	62
Projectors displaying patterns or pictures onto plain backgrounds	62
Effects lights	63
Miscellaneous light sources	63
MAC 500 Moving head projector.....	63
Lasers	63
LED's	64
Studio Cyclorama lighting.....	64
Ground row or top row lighting of backcloth or cyclorama	65
Special raised opaque cove	67
Typical lighting plots.....	69
Lighting plot for boxing or wrestling ring.....	70
A five person discussion format for a television show	71
Lighting a grand piano in the television studio	73
Lighting a grand piano in the theatre.....	74
A more complete lighting plot for a guest artiste and the pianist.....	75
Cooking program	76
Soft and hard shadows	78
A typical small studio	79
Pop group lighting in a small studio	81
Knebworth - A rock concert	83
List of Lanterns	84

Drama lighting plot with script for kitchen sink drama	87
Scene 1, a family enjoying the evening watching television	87
The close relationship of the lighting person to that of the director.....	92
Basic drama lighting plot.....	93
Getting the overall balance of light	94
How to paint with light.....	97
Orchestral lighting for television	99
“Keep It Simple”.....	99
Lighting an orchestra with diffuse soft light.....	105
Television lighting.....	107
Lighting designers of theatre and stage.....	107
Lighting for the theatre is one art form, lighting for television is another	107
Television studios.....	108
Lighting levels in television studios	108
The Maidstone studios.....	109
London News Network “London Tonight”	115
The London Studios	115
Television inside locations	121
Studio settings	121
Smaller independent studios	122
Setting up a temporary lighting grid	122
Projectors	122
Television daylight display screens	122
Studio facilities	123
Special effects inlay	123
Television cameras	123
Gamma correction.....	124
The colour temperature of studio lanterns.....	124
Television dimmer systems.....	125
The studio electricians	125
Colour filters or gels	126
Health and safety.....	126
Fog machines, dry ice machines.....	126
Snow special effects.....	126
Rain machines	126
Lighting for international ice skating events.....	126
“Holiday on Ice”	127
Just a bit of history	127
Lighting within art galleries	127
The role of the designer or art director.....	129
The property man.....	130
The carpenters	130
The stagehands	130
Plaster work.....	130
The graphics designer	130
Continuity.....	130
Make-up.....	130
The costume designer	131
Film studios.....	131

Outside locations or remotes	131
Fashion show outside location	132
A Simple lighting plot for a fashion show catwalk.....	133
Ghost scene	134
Technical tools	135
Video assist.....	135
Addavision.....	135
Camera filters for film use.....	136
Colour gelatines acetates and filters.....	136
Fluorescent lights and filters	137
Illusions or camera tricks	137
Control of individual lights in the studio.....	138
Film contrast and colour.....	138
Lightflex.....	139
Laboratory printing.....	141
Film transfers to other mediums	141
A D R (Analogue to Digital Recording).....	141
Aspect ratios past and present	142
Special equipment used in film and television.....	143
The Kestrel	145
Appendix on colour temperature and units of measurement.....	147
A beautiful black body.....	148
The colour temperature of various sources	149
Photometric units of measurement	149
1. Definition of the units.....	149
2. Lamberts Law.....	150
LED'S (Light emitting Diode's).....	151
References	153
Reference books.....	153
Author's brief history	154
A Brief Glossary of Film and Video Terms.....	155
Index.....	161

Acknowledgments

Acknowledgments

Dedications

I dedicate this book In memory of Luigi Bottone, Supervisory Lighting Director and Head of the lighting department at Thames television 2003. He was a top talent in lighting for Television and a source of great inspiration to all his friends within the Television industry. Whilst I was working at ABC Teddington studios, Luigi taught me to light for drama and light entertainment. This provided me with a solid foundation for the whole of my career in lighting for Television and film.

Special thanks to my dearest wife Val who has given me endless support during the many valuable hours of our family time spent producing the material to make this book possible. To my first wife Lisa and our daughters Ashling, Michaela, who all work in the film and Television industry, to my youngest daughter Emma who has given us lots of help and support in this project.

To all my friends who worked for “Intertel Television with studio and outside location facilities” at the Ealing and Wembley studios and the “TVi” Whitfield street studios London, over the many years and the many production company’s we all worked for such as the BBC, RTE, ITV, NBC, ABC, and many others all over Europe.

To my friend Frank Weeks for his help and support with this project and the use of his computer and accessories.

In memory of my special friend David Bailey.

To: - Dr, Frank Cottee & Jo Cottee for their very kind help with the location photographs of their home.

To: - “London News Network”, Mrs. Denise Harker MD, All the newsroom staff and engineers that I have worked with. Special thanks to Alastair Stewart, Lucy Alexander, Anna Maria Ash, Paul Green and Chrissie Reidy, for allowing me to use the photographs.

To: - “The Maidstone studios” and Mr Geoff Miles MD, Barry Nutt ex chief engineer, John Seagar technical operations, and all the staff who work there.

To: - “Red Door productions”.

Finally to all those special people and friends I have worked with during my career in this wonderful industry, I thank you all.

Introduction

To commence my book, all the attributed writings on this very large and diverse subject must be born in mind and attention should be focused on the fundamental beginnings and the nature of lighting inanimate objects or live subjects. For the person who requires a practical guide on how to light for television and film, without cumbersome reasons arguments, pros and cons, etc. This book provides proven examples of everyday lighting situations that may occur in any television or film studio and outside locations. One does not need to know how a television camera works or how a film camera works, but this knowledge is helpful and some attempt must be made to understand the basic principals.

To understand how the requirements for television and film in terms of the lighting luminaries, power requirements, the light intensities, and most importantly the colour temperature of the light sources, their directional angle and their quality as hard or soft light sources. Recognise the difference between hard shadows and soft shadows.

Let it be said that one does need a keen interest in the subject in order to master it.

This applies to all jobs that are executed with a masterly touch. The skill of lighting requires an artistic ability, you need to be artistic to be able to paint a picture with light and know your colours well enough to create depth by choice of colour. I will try to explain how this may be achieved later in the book.

The Qualities of light

The sunrise and the first rays of light shine through the early morning mist amongst the pine trees of the forest, quite a common sight to those who get up early and walk the dogs or ride their horses.

The sun setting and creating orange tinted clouds against a pale blue sky above with a graduated red sky along the horizon providing for a spectacular sunset, observation of daylight in all its forms should be done with great care and noted for the normal and special events of daylight and its ability to change colour and vary in brightness as clouds pass by.

Sunlight through leaves inside a forest may alter the colour by adding green to the area below or reddish brown during the fall (autumn). Reflections from buildings may bias the colour of the reflected light, and with a clear blue sky the shadows will be as blue as the sky light.

In winter with an overcast cloudy sky the light from the sun is totally diffused and the colour may be altered by pollution of the atmosphere, the quantity of light will be dependant on the thickness of the clouds and how many layers of clouds above ground, this kind of light will be very diffuse with very soft shadows and the light level may be so low for us to need artificial light to see our way.

The jet black sky sweeping in across the hills bringing the storm, a rainbow progressing its path driven by the rain in the distance with the sunlight over our shoulder, we as the observer standing in a dry place waiting for the rain to come our way.

The various angles of sunlight in winter and summer, short or very long shadows, and the days are very long in the northern and southern hemispheres compared to the equator where the changes from daylight and darkness come more quickly.

Nature provides many variations and we should try to observe these and remember them carefully. For the composition of the scenes that we create by our observations, are seen to be a creative art form that we may learn from experience of everything around us. Every day we all learn something new, this process must continue for us as we strive to become the creative artiste. The skill of the lighting person to recreate these situations inside a studio and to make them look real is in the making of a true artist.

Lighting for television and film presents a huge range for artistic expression. The principals are simple. Translating these principals into an-infinity of artistic illusions should remain a continuing challenge.

The Objectives of Lighting

- (1) Establish the mood of the scene for Tragedy, Suspense, Mystery, Humour, Gaiety, Romance
- (2) Establish the date period, time of the action, Dawn, Breakfast, Day, midday, Evening, Sunset, Night, spring, summer, autumn, and Winter.
- (3) Make a visual statement. Direct the attention to it.
- (4) Use light and darkness and colours to provide and create perspective.
- (5) Create your picture by the use of modelling, colours and décor lighting.
- (6) Try to ensure that shadows all fall in the same direction if they are to be seen.
- (7) The background should always be far enough from the subject to be lit separately.
- (8) Finally fulfil the technical requirements and maintain the correct exposure and colour temperature for the film in use, and keep the contrast range under control especially for television.



Early 6 am, cameras & lighting set up with dc arcs and reflectors for the “NBCtoday show” televising the May Day Parade in Constanta Rumania.

Tools of the profession

Familiarise yourself with each essential tool of this profession.

Our first tool is the device known as a “Light meter” this as its name does suggest is used to measure essentially the quantity of light from the source of the light, such as a single lit candle with one flame which may be considered as a basic unit of light, also the moon is a reflected light source at night, and the sun is the primary light source.

A 100-watt light bulb is a normal light source in most rooms of a house and at night it provides enough light to see the various objects in the room and is enough to read by.

We may include anything that burns as a source of light, most light also provides heat. If we are to compare the amount of light from a candle and a 100-watt lamp or a bonfire we need a sophisticated tool not only to compare the amount of light but how cold or warm the light is for example blue light orange light or red light.

When using a monochrome film or a monochrome TV camera. We may use a simple monochrome light meter which maybe calibrated in various scales, such as Lux, Foot candles, Lumens, Candelas, There are many light meters to choose from, for monochrome television it is only essential to have a single scale calibrated in foot candles and it does not need to be expensive as it will only be used to compare light levels from various sources, for film use it will need to have “F” stops and film speed related scales with index numbers.

For colour measurements a different kind of meter consisting of sensors for primary red, green, and blue and a small computer which provides a digital reading in degrees Kelvin, these meters are quite expensive, there are cheap versions but they are not very accurate. A colour meter is absolutely essential to ensure that studio lights are producing the same colour temperature with a given supply voltage.

Light-meters for incident light

The basic requirements of light meters should ideally combine the following features:-

- A quantity scale indicating the amount of light measured in Ft.c, with low, medium and high scales. A Cine scale giving number of frames per second with the film stock speed and related “F stops”, ASA, BSI, Din, and Exposure Values. Selectable ranges to cope with all variations and supplied with various directional attachments.
- The meter should be robust for outside use and have a suitable protective case. It should be noted that the Silicon cell electronic type meters are the most sensitive and have the most stable calibration, they are fitted to the latest meters and S L R

cameras, with measurements from full moon light to full sun light. Please note these meters require batteries to function.

- The self-powered selenium cell meters are not very sensitive to low light levels; however the Cadmium sulphide CDS type meter is very sensitive at low light levels.
- Directional attachments to light meters, these are usually in the form of cones, domes, and flat opaque clip-on fittings, The opaque dome fitting is used to collect ambient or incident light to the meter and provides a wide angle view of the sources to the meter. The flat opaque fitting is more directional and is used to measure the incident light from the sources. The cone is very much more directional but nothing like a spot meter. The meters are normally calibrated for the use with these attachments.

The Western Euro Master is used for stills photography whilst the “Brockway Sekonic” and “Spectra” meters have all the features required for film and television.

Colour meters

Used for colour measurements of all light sources, they have a scale in degrees Kelvin or a digital read out in degrees Kelvin, the ability to handle a large contrast range, and as a bonus a selectable Ft.c Scale. Most important is the calibration certificate and the accuracy of the meter. A Colour meter is essential as a tool for film and Television work and may be hired or purchased.

Spot meter (reflected light meter)

Never point it directly at the Sun!

Equally essential is a “SPOT” meter to measure the contrast range, or lighting ratio of the lighted scene. The “Minolta Digital” spot meter calculates contrast ratio between highlights and shadows to within one tenth of a stop. The “Gossen spot master 2” does the same. The spot meter essentially has a narrow angle lens with a one-degree wide highlighted spot; it compares the light seen through the lens to a calibrated light source within the instrument, and provides comparisons from darkness to bright sunlight to obtain the contrast ratios. Reflector cards are provided to place within the lit area these are often used with spot measurements and may be purchased with the spot meter.

Monocle for looking into the lens of luminaires

These monocles are small hand held neutral density filters and are specifically made to look into the light sources without damage to the eyes, They are needed to examine the focus of a luminaire and if the luminaire needs a new light bulb, also to check if the lens is clean or very dirty. It is a very useful tool to possess.

Land Polaroid camera

An essential tool for motion picture filming, the camera is used to verify lighting set ups and records the continuity of lighting. This provides peace of mind for difficult exposures and the colour of light sources and is used to verify the exposure in stills photography.

Digital camera

Used for recording still photographs of scenes. It must be of high quality at least 5 megapixels for good resolution and have selectable ranges for setting colour temperature, exposure, focus, and must have an optical zoom lens. Storage media such as Flash memory up to 512 MB or equivalent is recommended.

Lighting stencils

Metric and imperial stencils for outlines of standard lanterns used to create lighting plots to the appropriate scales of plans and drawings.

Tape measure

The tape measure is essential to measure the lens focal distances and depth of field.

A digital electronic tape measure is used to survey heights of ceilings within large buildings and the distance from the lanterns lens to the subject.

A brief list of Luminaires used for television, film and theatre

The box or housing for the light sources, are called “LANTERNS” or “LUMINAIRES.” They also have many other slang names.

The lenses fitted to the front of the luminaire to focus the light are known as “FRESNEL” There are three basic types, clear, semi frosted, and frosted and are made to produce different angles of illumination depending on the size of the lantern and the design.

Globes, bulbs, and lamps consisting of filaments or arc posts enclosed in a glass or quartz glass envelope which produces a source of light when a voltage is applied to it Globes, Bulbs, Lights and Lamps a general terminology for a source of light.

“PAG-LIGHTS” “LOWELL-LIGHTS”, 30-250 watt. Battery operated Quartz Halogen 30V bulbs the lanterns have a small reflector and handle, which may be mounted on a stand or hand held and comes with a battery pack which at full charge may last about half an hour this really depends on the wattage of the bulbs fitted.

“MINISPOT” “INKY DINKY”, a Fresnel lens 100 watt lantern, a beam width adjustable variable focus illuminator with a Quartz halogen bulb, which has replaced the tungsten filament type of bulb once used. It has a fresnel lens at the front with a mirror bulb assembly, which moves inside the housing to focus the light through the lens, a small lantern that may easily be hidden away from direct view.

“PUP”, Mole-quartz “TWEENIE”, “MISAR”, “SOLAR SPOT” 250-500 watts, all Fresnel lanterns with variable focus has the same internal arrangement as the MINISPOT.

”ARRI 300” Many different companies around the world have manufactured Luminaries. Such as, “IANERO”, “Mole Richardson”, “Strand Electric”, “Cramer”, and under many other different names.

“REDHEAD” 800-watt is a variable focus open type lightweight lantern without a fresnel lens often used by “Electronic News Gathering” camera crews.

“NOOKLIGHT”, a 500-1000 watt, linear bulb floodlight known as a “Builders light”, used as a flood light for scenic backings.

“PAR CANS” 1000 Watt, these lanterns use sealed beam bulbs, wide, medium, narrow, and super narrow. All fitted with P A R quartz halogen bulbs (Parabolic Aluminised Reflector) used for general illumination at pop concerts. Par-Cans are often used in pairs with 110v bulbs in series. PAR-64 = 1000 W at 3200 K.

“COOL LIGHTS” uses 1000 watt, PAR bulbs with the reflector and lens separated, by changing the reflector for a dichroic one the colour temp is changed to daylight.

“SILHUET” CCT, a 2KW Pattern projector

“PATTEN 264” the Strand Electric lantern is a 1Kw profile spot.

“HARMONY” 15 / 28 1 Kilowatt profile spot.

“POLARIS” “BABY” spot, a 1 Kilowatt Fresnel spot.

“SCOOPS” 500-1000 watt with a reflector of 18 inches diameter, an old design made by Mole Richardson usually used in pairs, looks like a microwave dish, used for soft light, base light or fill-light. Up dated with a QH Edison screw bulb (a linear bulb enclosed in a second envelope of plain or frosted glass).

“GROUND-ROW” 1250-watt linear single lanterns with special reflectors, and “Four-lights” (four 1250 watt lamps in four compartments contained in one unit) for cyclorama lighting. They are fitted with special mirror reflectors to provide a vertical even wall of light from top to bottom of a cyclorama.

“BLONDE” is a 2kw version of the open type reflector variable focus lantern. These open lights create small double shadows due to the length of the filaments in the bulbs and the type of reflector used. They must be used with a safety glass in front of the bulb.

“BROAD” is a 2 Kilowatt soft light (old design) uses 10 off 200 Watt ES silver mirror back bulbs, sometimes called an egg-box. This lantern has been replaced by better and more efficient designs such as the “North-light” or “Antares”.

“CASTOR” “2K” or “JUNIOR” is a 2 Kilowatt Fresnel spot lamp with adjustable focus or angle of illumination,

“TWISTER”, is a 2500 or 5000 watt lantern designed specifically for TV studios. It is a wide-angle spot light and a soft floodlight it uses a Dual filament QH lamp. It is often used with a fibreglass scrim as a diffused source or with a colour filter material (Lee Filters) to colour a background or a white cyclorama cloth.

“POLLUX”, “5K SENIOR”, or “5K SPOT”, a 5000 watt lantern with variable focus which has a very useful wide-angle fresnel lens and is pole operated.

“SKY-PAN” “SKYLITE”. 2000 - 5000 watt flood light for large area cyclorama lighting, a shallow dish having a very wide beam spread,

“IANIRO TENER”, 10,000 Watt, wide-angle fresnel spot that will also take a 5K bulb, the lantern is useful for its very wide angle of light and is pole operated.

“ANTARES” is a 2500-watt soft light that uses two 1250-watt linear bulbs and a specially shaped reflector, which hides the bulbs from direct view. The lantern is small area source of soft illumination.

North-lights

1000-5000 watts provides a large area source of soft light or fill light. Called a north light because the paint colour on the reflector was originally blue white thus producing a slightly cold light, this is now mostly ignored by being painted over with plain white. North-lights consist of oblong or square boxes open one side, fitted with inward facing linear QH bulbs that are individually switched on or off, the special blue white painted reflecting surface inside that keeps the colour temperature slightly higher than ordinary white paint, scrim frames are provided for each version. A 10kw version is also available. They are a very popular wide-angle large area soft light. A metal hood fitted to the top of the box is advisable for cutting spill over the top rear of the “setting” (A Set or scene consisting of stock flats to the left and right and rear inside which the action takes place). A similar light used in film work is known as a Soft Box ranging in size from 30 centimetres square and up to 2 metres by 3 metres in size.

Mini brutes

A Six light or Nine light and a Twelve light version, “MINIBRUTES” use sealed 650 watt PAR 3200 K, or FAY 5000 K bulbs, Q H par bulbs are pre focused, and are available in different angles wide, medium, narrow and super narrow, they are used for large area coverage for example the large audiences in a theatre or circus tent. Bulbs are set into “gimble” boxes in order to point in different directions.

Brutes

A term used for a DC arc lamp 225 Amps at 120 volts 27000 Watts with a fresnel lens 24³/₄ inches in diameter. The “Baby Brute” has a lens diameter of 14 inches. D C arc lamps are not used very much for television they are mostly used for filming on outside locations.

The carbons control the colour temperature and are selected mainly for daylight use the carbons last about 40 minutes. White carbons are used with corrective filters for daylight and yellow carbons for 3200 K. The lanterns are extremely heavy they often run from separate DC generators at 110 volts, for a luminaire of 10,000-watts or more, the DC current is very high and cables tend to be very thick. The flexible copper cables are extremely heavy and tend to be supplied in 100 foot lengths connections are made to brass “A” frames in wooden boxes for extending the length. Normally the generators are close to the luminaries, be aware this may create a noise problem for live sound. A warning please note an arc is a very powerful source of ultraviolet radiation never use it without a lens or protective UV glass filter, always

replace the fresnel with a Pyrex glass UV filter if you need to use the lantern without the fresnel lens, this produces a very wide angle source of hard light.

Compact source iodide

These lanterns have been used within the film industry but are not very popular in television as the colour is slightly odd but with suitable correction filters they have proven to be a very useful lantern producing high levels of light output for a very small unit size.

Technical Information

Performance data for C.S.I. Twin. All readings taken to 50% of peak.										
	10 Feet		20 Feet		40 Feet		50 Feet		100 Feet	
	Lighted area in feet		Lighted area in feet		Lighted area in feet		Lighted area in feet		Lighted area in feet	
Lens data	Foot candles	H W	Foot candles	H W	Foot candles	H W	Foot candles	H W	Foot candles	H W
Clear spot 10°	19800	18" dia	4960	3' dia	1240	6' dia	800	7' dia	200	14' dia
Diffused spot 14°	16800	21" dia	4200	3' 9" dia	1050	8' dia	675	9' dia	165	18' dia
Narrow angle 15° × 24°	7500	2' 4" × 4'	1875	5' × 8'	468	9' × 16'	300	12' × 20'	75	24' × 40'
Wide angle 24° × 60°	1792	4' × 12'	448	8' × 24'	112	14' × 42'	72	18' × 54'	18	36' × 108'
Flood 65°	1000	12' dia	250	24' dia	62	48' dia	40	62' dia	10	124' dia
Compared with a 225 amp brute arc (readings taken with same meter)										
Full spot	24320	2' dia	6080	4' dia	1520	7' dia	972	9' dia	243	18' dia
Full flood	5888	7' dia	1471	14' dia	367	28' dia	235	34' dia	59	68' dia

The C.S.I. from Lee has revolutionised location lighting for both film and television.

Compact, lightweight, weatherproof – providing an unbeatable combination of light out-put and low current consumption from the 1kw C.S.I. Par 64 sealed beam. Lee C.S.I. fittings are available in single or twin head versions with hot re-strike. The performance figures show just why they have become the new standard in film and T.V. lighting. We have developed a lamp head which will answer most of your location lighting problems the modern way.

These are just a few of the productions that have solved their lighting problems the modern way – The C.S.I. Way.

Films

*The Slipper and the Rose
Superman
Beau Geste
Star Wars
The Omen
All Things Bright and Beautiful
The Adventures of Sherlock Holmes
Liztomania
Rosebud
The Romantic Englishwoman
Brannigan
Juggernauts*

*Tony Imi
Geoffrey Unsworth
Gerry Fisher
Gil Taylor
Gil Taylor
Arthur Ibbetson
Gerry Fisher
Peter Suschitsky
Denys Coop
Gerry Fisher
Gerry Fisher
Gerry Fisher*

*Walt Disney Productions
U.S. 1976 Political Conventions
Outside Broadcast of H.M. Queen Elizabeth Silver Jubilee Celebrations*

single

Volts 120-240
Watts 1,000
Dimensions Height: 17"
Length: 13½"
Width: 12½"
Weight 22 lb

choke

Weight 48 lb
Dimensions Height: 10" Length: 16½" Width: 10"

twin

Volts 120-240
Watts 2,000
Dimensions Height: 17"
Length: 25"
Width: 12"
Weight 37 lb

also available:-

A comprehensive range of accessories

Barn door, Diffuser frame, Extension cable – 25', 50' and 100'
Cross bar and extension, Lenses.

CSI lights "Compact Source Iodide"

H.M.I. sources

The replacement for the arc lamp is known as The H M I (stands for Hydrargyrum Medium arc length Iodide) it is supposed to be a flicker free cold light. But may cause problems with Film cameras depending on the shutter speed and frame speeds. It does not normally cause any problems with UK television cameras. One great advantage of the HMI, they produce

very little heat for large amounts of light. This luminaire is powered from AC and has a special starting transformer, the striking voltage is approximately 20 to 60 kilovolts for a one second surge and the arc needs about 3 minutes to stabilize, they need a special ballast unit to run on which regulates the voltage to the arc, as the gap gets bigger inside the bulb. An increase in volts reduces the colour temperature and a drop in volts increases the colour temperature. The largest H M I is 25,000 watts the smallest maybe 200 watts and the normal colour temperature is daylight at 5600 deg Kelvin plus or minus 400 degrees K, that equals an 800 degrees K variation.

The bulbs are very expensive, consisting of a sealed high-pressure discharge arc within a special glass ceramic gas filled envelope. After switching on they are not dimmable. A set of shutters may be used to control the light output but with caution as the shutters get very hot and must not be left in the closed position.

They take a few minutes to reach full light output and colour temperature. HMI luminaries are not generally suitable for television studio productions.

They are excellent for outside daylight use. But keep tabs on the Colour Temperature of each lamp by attaching a luggage label with the last Colour Temperature reading clearly marked and frequent checks of colour temperature should be made.

For film use, close attention must be paid to shutter angle synchronization and film speed, at 24 Frames per second the HMI is running from 50 HZ AC supply, the flicker is at 100 HZ, and each frame gets 4•16 beats per frame. This is acceptable.

It is interesting to note that special high frequency versions are available for film use to minimise shutter problems at various frame speeds.

By comparison to an arc-lamp a 12000 watt H M I lantern out-performs the arc at a quarter of the power consumption 55 amps at 240 volts, and a 1200 watt HMI produces the same amount of light as a 9 light, yet a QH 9 Light draws 5850 watts at 240volts, HMI can provide more light than a carbon arc-lamp. At Ten times better efficiency and a 200-watt HMI is equal in light output to a 1000 watt QH freznel lantern.

All HMI lanterns need colour correction gels to obtain identical colour temperatures.

This may seem a complicated or formidable list but it is only a guide to a host of luminaries available from many sources.

HMI Lanterns are being used in the television studios for special effects but not for general lighting, because of the very high light levels that may be obtained they may be used to provide large areas of indirect light through very large sheets of white calico canvas ideal for commercial advertising shoots.

Barn doors

These are a set of two or four hinged metal flaps attached to a frame that fits into a slot in front of the filter slot parallel to the fresnel lens of the luminaire. They are essential to control the shape of the light from the lamp and remove any overlap or spill light.

The drawing below shows a pole operated Fresnel spotlight. The first object to the right of the lantern is a mirror reflector, then the bulb, next the full size glass lens, and the Fresnel type lens that is used to replace it.

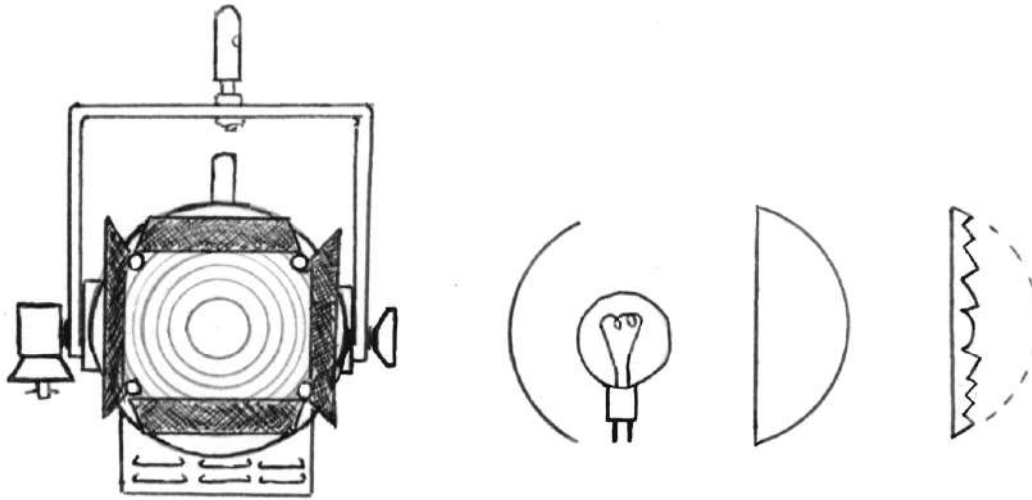

Full flood and full spot

This refers to the focus of the luminaire, full flood is when the focus is at the widest angle; likewise full spot is at the narrowest angle. Note the light output is less at full flood and much higher at full spot, so “focus” changes the light level of the luminaire.

Arrangements of wire scrim in circular frames for freznel spots

Bottom Half	Bottom third	Side Half	Three quarter side and bottom	
				Double thickness at dot line
Diagonal top Or bottom	Keyhole double thickness at bottom	Centre section of wire vertical		

Metal gobo	Snoot	Revolving slot	Arc shutters



The Maidstone Studios, lighting boat system supports 6-10 lanterns. The lighting boat is supported by steel cables wound onto 2 motorised drums.

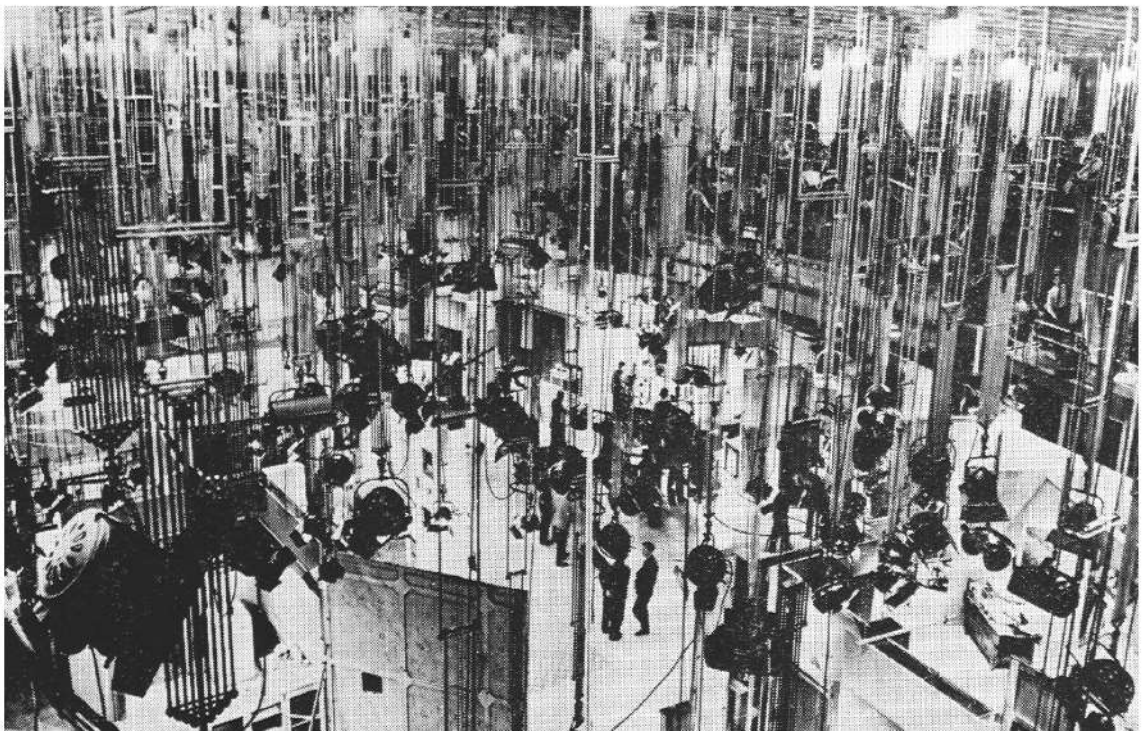

“ATV Elstree” studios telescope system of individual lantern suspension.

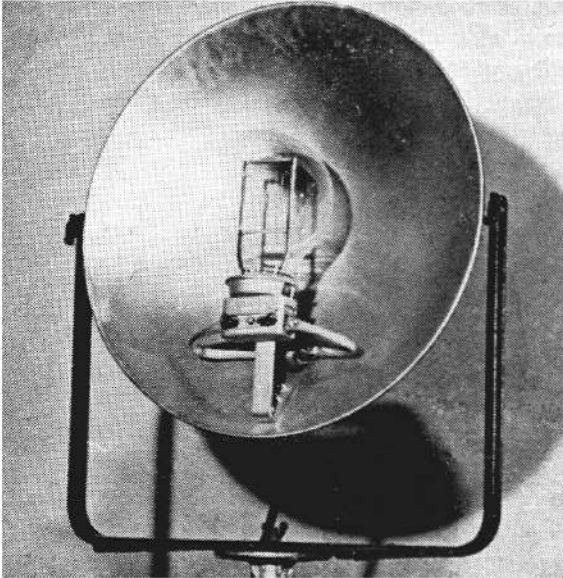

The Skypan is fitted with a bi-post 5KW bulb of 3200 degrees Kelvin it has a very wide angle of light, and is often fitted with a circular rim to reduce the side spill. This lantern is mainly used to light very large painted back drops or cycloramas inside a studio. They are rarely found in television studios

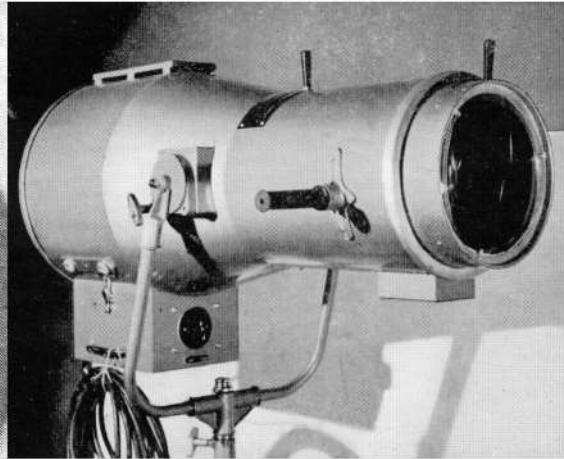

Follow Spot One of the oldest types of lantern used in theatre film and television. This version rated at 2 KW at 3200 K fitted with plano-convex lenses has a complicated optical system with variable focus and variable diaphragms to provide a concentrated spot with sharp or soft edges and is used to follow artistes about the stage

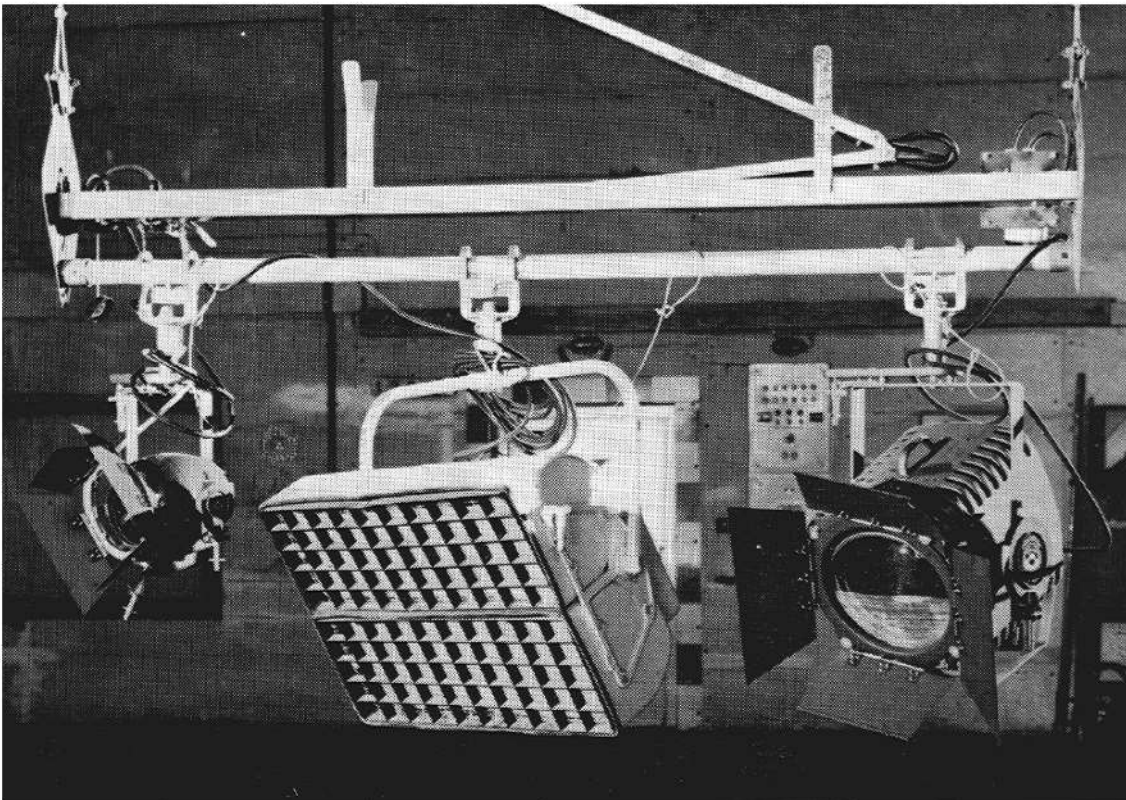

Left to right, 1 KW Fresnel spot, 2 KW Egg box soft light, and 2 KW Fresnel spot, with hand winch type lighting barrel suspension system



Ianiro "MISAR" 250-500 Watt Fresnel spot



ARRI 300 is a 300 Watt lightweight compact Fresnel spot



Martin

500 Watt colour effects projector Remote controlled by DMX computer.



Ianiro Quartzcolor "POLARIS" pole-operated 1 KW Fresnel spot



**Ianiro "POLLUX" 5KW Pole
operated pan Tilt and Focus**



**PAR_CAN (long version) 1000 Watt, showing the barrel clamp for hanging from a
2 inch pipe or barrel support attached to the swivel saddle and showing the safety
lanyard**



Ianiro "MINNETTE" 1200 Watt soft light uses 2 linear bulbs floor standing back-drop or cyclorama lantern with a compensated ear shaped reflector to evenly light vertical surfaces and is often used to light the corners of the cyclorama. A pole operated version is used for the overhead corner position.

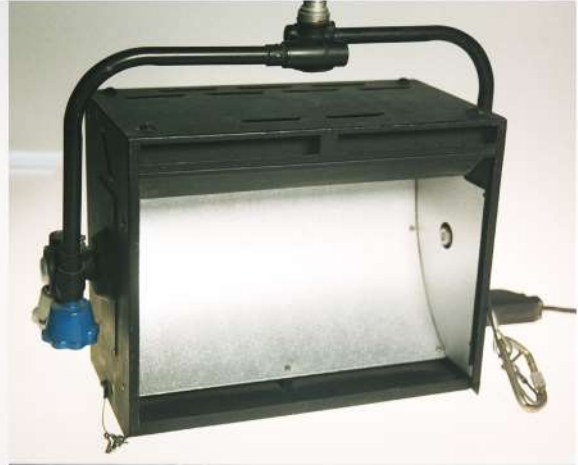

Ianiro Pole operated pan and tilt 2 KW compact soft light, the bulbs are hidden from direct view, note the vents at the top edge.



Ianiro is a pole operated 2.4KW soft light which uses 4 linear bulbs.



Ianiro "RED-HEAD" A well known lightweight 800 Watt portable lantern. It has an open front reflector and is fitted with a clear safety glass or diachroic blue glass for daylight colour correction. It must never be used without the safety glass as there is a danger of the bulb exploding; the safety glass stops any possible shower of red hot glass being thrown out.



Ianiro "RED_HEAD" showing the rear focus knob and mounting cradle, no gel frame but clips are provided on the rotatable barn-doors for a sheet of colour gel.

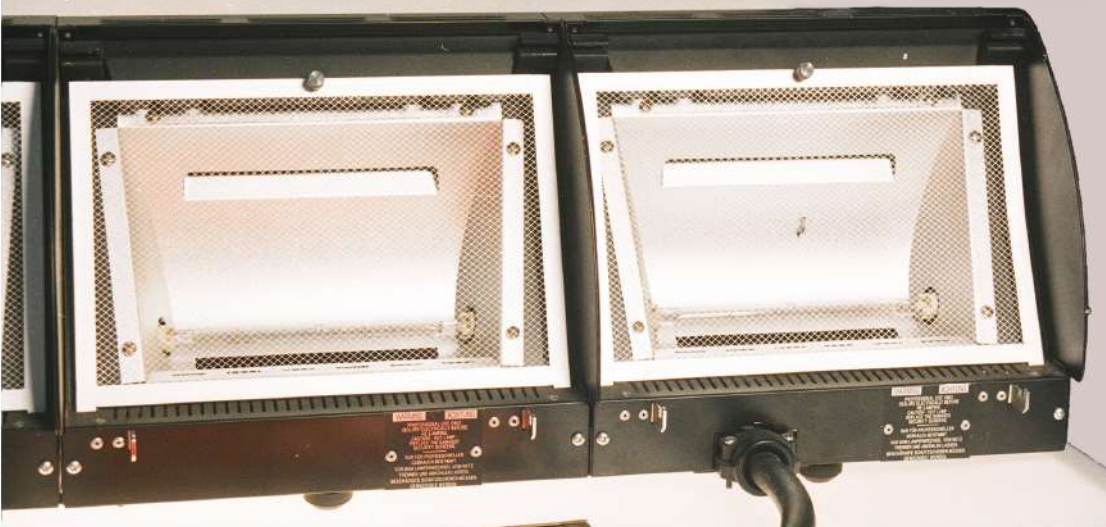

The new style 4 light ground-row for cyclorama lighting has ear shaped reflectors to provide a more even vertical spread of light.



The old style 4 light ground-row with parabolic reflectors tilted at 45 degrees.



Shows a dual 1250 Watt 4 pin and a dual 2500 Watt 4 pin quartz halogen bulb, a linear 1250 Watt, a 2000 Watt 2 pin, and a 1000 Watt 2 pin QH bulb.



All the pack shots were photographed on the Perspex cove shown.



Pack shot example for commercial advertising.



Close ups of dual filament structures within the quartz glass envelopes



PAR-CAN short version uses 500 Watt or 1000 Watt PAR bulbs, has a dual saddle for floor standing.



PAR BULB the double sealed the quartz halogen bulb is inside the external mirror backed envelope.



Another view of the short Par-can, normally the majority of lanterns are fitted with EU-IEC colour coded plugs. 16Amp, 32Amp, 64Amp and 128Amp



Janiro "CASTOR" 2KW Fresnel spot lantern, pole operated focus, pan, and tilt. This lantern is used as a workhorse in most studios.



Side view Strand "Harmony 12-28" Profile spot.



Front view "Strand Harmony 12-28" A colour changer may be attached to the

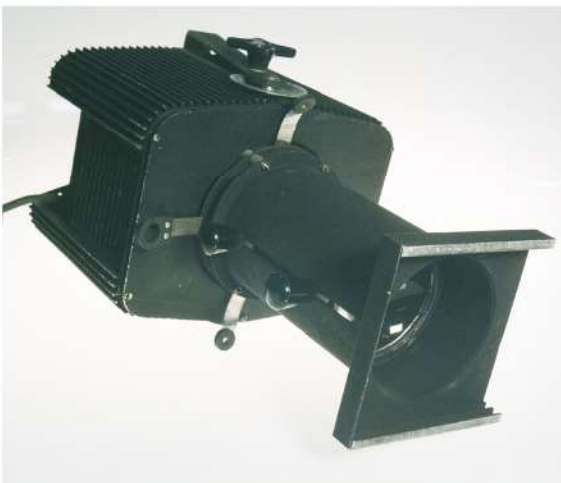

1 KW Profile spot note the tabs to control the shape of the projected light



CCT "Silhuet" 2 KW projector for long range follow spot use.



A metal slide that fits into a pattern spot and is used to project a pattern onto a plain surface



GOBO arm, adjustable black flag to position in front of a lantern to avoid light falling on a specific item or part of a display.



The above items in a clockwise direction, Floor mount female spigot plate, a barrel clamp to male spigot bolted to a 2 inch pipe which in turn could support two lanterns either side, a Gaffer scenery clamp, a small spigot clamp, and a male to female spigot adaptor half inch to one inch diameter.

LOWEL omni kit

An extremely useful lighting kit containing virtually everything you would need for a two person interview indoors at some ones home or office. Additional kits for more equipment are available to expand the system. Diachroic correction glass is available in order to use the kits in day light.

Croniecone

A metal cone to box shape device that fits into the barn door slots of a 5 K or 2 K Fresnel spot lantern and provides large area mounting frame for a diffusion screen turning a hard source of light into a soft light.

High key and low key

Do not get confused with these two descriptions, High key means brightly lit with lots of light every thing well illuminated. Low key means the lighting is gloomy with odd highlights to pick out some features that give the picture meaning, faces under exposed but for highlights in the hair or from behind the actors or to one side of the face only. Backgrounds are seen in detail but only with a small amount of light.

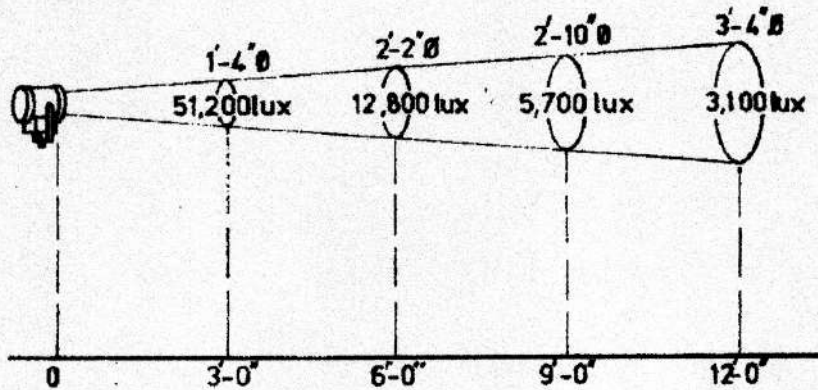

Fig.1 SPOT

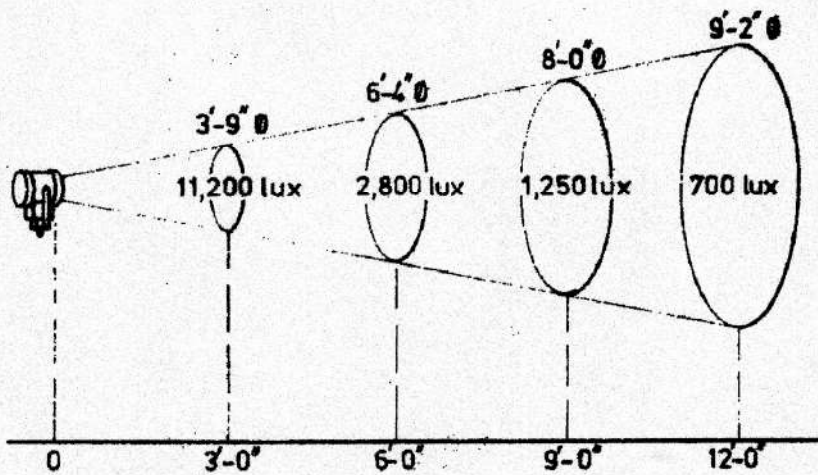
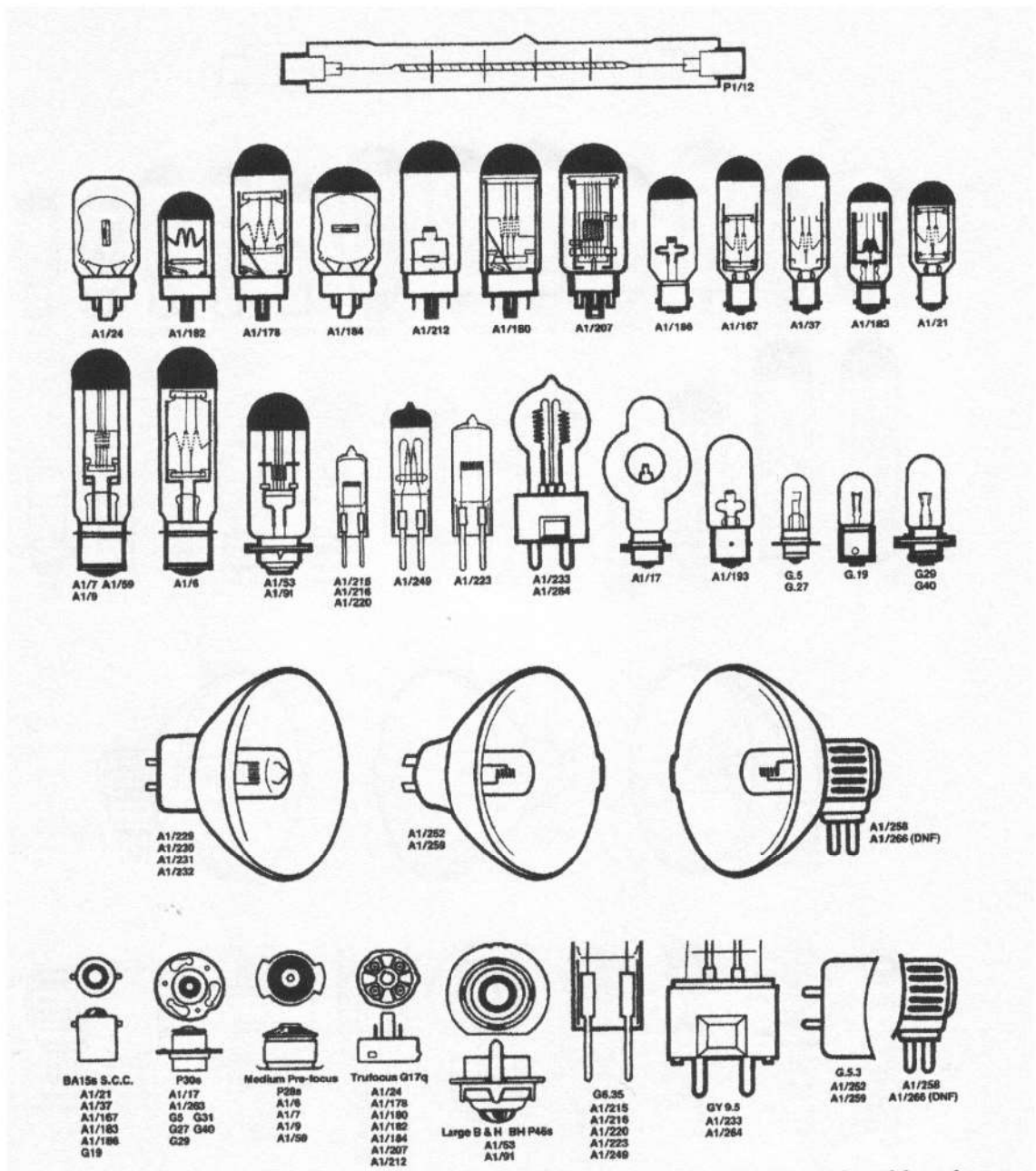

Fig.2 FLOOD

NOTE: Beam perimeter 50% Intensity.

Scale	—	LEE ELECTRIC (LIGHTING) LTD.	A4
Drawn	d.l.	'SUN GUN' 200W. H.M.I.	123-26
Date	1979 10 12		
Checked			
Approved			
		PHOTOMETRIC DIAGRAMS	

Lee Electric lighting Ltd "Sun Gun" 200 Watt HMI lantern, a chart quantifying the light output against distance



An example selection of various projector bulbs and lantern bulbs from the old to the new there are thousands of different types of bulbs and the list below.

Capsule finish bulbs.

Cap	W	Type	Cap	W	Type
G6.35	250	64516	GZ9.5	650	A1/233
GY9.5	500	A1/244	GY16	2000	CP43
G6.35	300	64516	G12	575	HPL-575
GY9.5	300	M38	GY9.5	500	M40
GY9.5	500	T18	GX9.5	1000	T19

Par bulbs, Par 56=GX16d 300w medium -flood,
Par 64= GX16d 1000w flood

Bulbs

PROJECTOR LAMPS – SUBSTITUTION GUIDE												
Hanimax Ref.	V	W	Base	Atlas Ediswan Wotan Osram (GEC) UK	Osram (Germany)	Philips	Sylvania	Mazda (France)	BLV	Fuji	Kondo	Iwasaaki (Eye)
A1/6	220, 230, 240, 250	300	P28S	A1/6	58.8591E	6131C	SYL 6	630 (1)		FC 30	KP 10	
A1/7	220, 230, 240, 250	500	P28S	A1/7	58.8890E	6152C	SYL 7 (DBT)	650 (1)		FC 25	KP 10	
A1/9	220, 230, 240, 250	750	P28S	A1/9	58.8990E	6153C	SYL 9 (DKK)	675 (1)		FC 42	KP 12	
A1/17	8	50	P30S	A1/17	58.8007	13120C	SYL 17 (CXR)			CA1-3	KP-GT	
A1/21	220, 230	100	BA 15S	A1/21	58.8192	6158N	SYL 21	610A		FC 1	KP 8	
A1/24	125	150	G17Q	A1/24			DFN					
A1/37	220, 240	300	BA 15S	A1/37	58.8585	7212N	SYL 37 (CNP)	630A		FC 10	KP 8½	
A1/53	115, 220, 240	750	BH P46S	A1/53	58.8980/1C 110V only	6153H	DEJ 120V			FC 13	KP B/46	
A1/59	115, 220, 240	1000	P28S	A1/59	58.8995E	7242C		6100 (1)		FC 47	KP-12 Net	
A1/91	115, 220, 240	1000	BH P46S	A1/91		7242H	DFY 120V			FC 15	KP B/46	
A1/167	220, 240	150	BA 15S	A1/167	58.8297	13141N	SYL 167	615A		FC 4	KP 8	
A1/178	220, 240	300	G17Q	A1/178	58.8597	6280C	SYL 178 (CSF)	6308A		CG 20	KP-TF/10	
A1/180	220, 240	500	G17Q	A1/180	58.8897	6282C	SYL 180 (DBS)	6508A		CG 30	KP-TF/10	
A1/182	220, 240	150	G17Q	A1/182	58.8295	6284C	SYL 182 (CTD)	6158A		CG 3	KP-TF/10	
A1/183	220, 240	300	BA 15S	A1/183		7066N	BEL			FC 11	KP 10S	
A1/184	21.5	150	G17Q	A1/184			DCA				KP TFR/12L	
A1/186	12	100	BA 15S	A1/186	58.8105	7238N	SYL 186 (BXT)	1810PRA		FC 3	KP-8	
A1/193	12	100	BA 21S	A1/193	58.8107	7909J	SYL 193			FC 6		
A1/207	220, 240	1000	G17Q	A1/207		6296C	SYL 207				KP-TFM/12	
A1/212	24	150	G17Q	A1/212	58.8224	6289C	SYL 212 (CYN)			FC 23	KP-TF/10	
A1/215	12	100	G6.35	A1/215	64625	7023	FCR	1 PR 100	1401	JC 12V 100W	JC 12100	JC 12V 100W
A1/216	24	150	G6.35	A1/216	64640	7158	FCS	1 PR 150-24	1403	JC 24V 150W	JC 24150	JC 24V 150W
A1/220	12	50	G6.35	A1/220	64610	7027	BRL	1 PR 50	1400	JC 12V 50W	JC 1250	JC 12V 50W
A1/223	24	250	G6.35	A1/223	64655	7748	EHJ	1 PR 250	1405	JC 24V 250W	JC 24250	JC 24V 250W
A1/229	8	50	G6.35	A1/229	64607 (glass reflector)	6847 (glass reflector)	EFM			EAR 850 (glass reflector)		JCR 8V 50W
*A1/230	12	75	G6.35	A1/230	64615	6853	EFN		1476	EDR 1275		JCR 12V 75W
*A1/231	12	100	G6.35	A1/231	64627	6834	EFP		1477	EDR 12100		JCR 12V 100W
*A1/232	15	150	G6.35	A1/232	64634	6423	EFR		1478	EDR 15150		JCR 15V 150W
A1/233	220/230, 240/250	650	GY9.5	A1/233			SYL 233 DYR					JCD 220V 240V 650W
A1/249	220/230, 240/250	300	G6.35	A1/249	64661	7774						
*A1/252	24	200	G5.3	A1/252			EJL					
A1/258	24	250	GY7.9	A1/258			EMM			EDR 24200		
*A1/259	24	250	G5.3	A1/259	64653		ELC					
A1/263	8	50	P30S	A1/263								
A1/264	120	600	GY9.5	A1/264			DYS					JCD 120V 600W
A1/266 (DNF)	21.5	150	GX7.9				DNF					

* Incorporates dichroic reflector

PHOTOGRAPHIC LAMPS												
P1/12	220/230, 240/250	1000	R7S	P1/12	64580	PF 800R	FDG DYC	IPH1000	1302			

EXCITER LAMPS												
		Amps										
G5	6	1.0	P30S	G5		7210C	BSB					KE-07
G19	4	0.75	BA15S	G19		7253N	BRD			FCE 15		KE-03
G27	4	0.75	P30S	G27	8005	7090C	BRK			FCE 17		KE-04
G29	4	0.75	P30S	G29	8004	7853C	BRS			FCE 16		KE-02
G31	4	0.75	P30S	G31			BGB			FCE 14		KE-01
G40	6	1.0	P30S	G40		7708C	BSK					

omni-kits

solo kit

kit code: 01-96

specifications

size: 28" x 17½" x 8¾" [72 x 44 x 22 cm]

weight: 58 lbs. [26.4 kg]

materials: rugged, high density polyethylene

compartments: see "customizing"

contents

4 omni-lights with #1 reflectors,
16' cables (less lamps) 01-10
2 tota-lights, 16' cables (less lamps) T1-10
2 #3 super-spot reflectors 01-17
4 barndoors—complete 01-20
2 diffused safety glass 01-50
3 full scrims 01-54
2 half scrims 01-55
2 graduated scrims 01-56
1 cookaloris 01-57
3 tota-brellas T1-25
6 tota-frames T1-20
1 package day blue gels T1-70
1 package frost gels T1-72
1 package assorted gels T1-78
4 tota-flags T1-52
2 tota-reflectors T1-54
6 flexi-shafts—16" (3) T1-50
2 tota-tatches T1-34
5 omni-stands 01-33
2 tota-mounts T1-32
1 gaffer-tape, 12 yds. GT-12
3 tota-clamps T1-30
1 omni-lampak 01-61
1 tota-lampak T1-61
1 tota-pocket 01-65
1 case 01-86

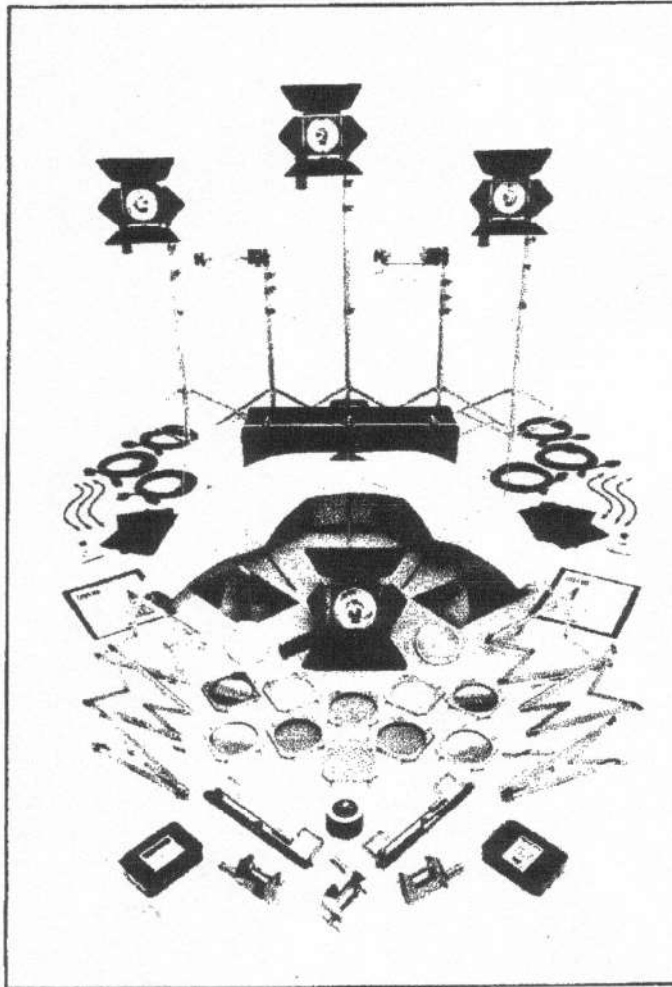

An extremely useful lighting kit containing virtually everything you would need for a two person interview indoors at some ones home or office. Additional kits for more equipment are available to expand the system. Diacroic correction Glass is available in order to use the kits in day light.

available at authorized Lowel dealers

lowel ™

SOLE U.K. AND IRELAND DISTRIBUTOR

Fill light

These are the luminaries for correcting all the hard shadows cast by dressing lights key lights and any other luminaries used. The luminaries to provide fill light are hung to cover as much of the playing area of the set as is practical, they are placed as low as possible but must allow room underneath for the sound boom operator to freely extend the microphone into the set and place it alongside any of the artists positions, fill light reduces the shadows cast by the beams of the key lights and modelling lights especially the facial shadows around the eyes and under the nose and chin. It must also relate to the time of day or night scenes and keep the shadows slightly transparent on the set and very transparent on the faces.

Fill lights are the most difficult luminaries to place on the lighting plot and often need to be moved on the day of the light setting due to many unexpected shadows of the boom microphone and camera positions etc. They are usually the last to be adjusted in intensity and position as their function effects, mechanical needs, time, mood, appeal and most of all establishing lighting balance. The softest light is shadow less.

Base light

Used to provide an overall soft light to all corners of the studio scenic settings, these are not the working lights of the studios but luminaries that produce the least possible shadows intrinsic to their mechanical design, read under “Scoops” “North lights” “Sky pans” “Reflectors”. Base-light is only required in television studios because the rendition of a black background is set by the electronics within the camera.

This applied to vacuumed tube photon emission type camera pickup tubes, such as the Plumbicon, Image orthicon, and Vidicon. To someone visiting a television studio walking onto a set depicting a night scene rather brightly illuminated is confusing unless you have the knowledge that the camera tells lies.

The experience brings up the statement that NO part of a television production should be judged by the visible conditions on the studio floor, Judge only by the results on the colour monitors.

Now that studio cameras are all using CCD there is very little need to provide base light any more, unless you prefer to use it. Auto-black and auto white normally take care of these extremes. Electronic bias light may be used to reduce contrast range on CCD cameras.

Base lights are very wide-angle floodlights with diffusers to soften the light and light out the shadows. As a light on its own it produces a dull uninteresting picture. It may be used to control the contrast range of the overall illumination.

Key lights

The “Key” light a principal source of light, in most cases this luminaire will be a Spotlight of some type normally placed at the side frontal position in relation to any predetermined artists position marked on the lighting plan of the studio floor, with the marked camera position agreed at the last outside rehearsal before entering the studio. It is the principal source of light and is used as the overall lighting level reference to determine the exposure or “F” stop of the cameras as well as the intensity of all other luminaries in the scene which are set and related to the key light, this includes the back lights, fill lights set dressing and related lights outside windows establishing the mood day or night. There will be several key lights in a single scene because of the different positions of the artistes and the movement of cameras. In a television studio, the key light for one position is often a backlight for another position, cross camera angles are the normal action. For film these cut a-ways would be separate camera shots illuminated separately. Placement of the key light is of extreme importance as it establishes the shadow moulding of the face. Too far to the left or right, too high or too low, will be unflattering to the face. Normally the key light would be a variable focus one with a Fresnel lens and barn doors, set to the widest beam spread to avoid defined hot spots and unwanted light masked off by the use of barn doors. The hardest light source in general use is the arc lamp as it is virtually a point source, Key lights are said to be hard source of light. Bulbs with long filaments are not point sources of light.

Modelling light

Known as counter keys, secondary keys, balance lights, depending on the application these terms do not indicate much about their use, they are normally used to model and balance the face when placed at right angles to the key light they serve as cross lighting, they create roundness to objects or scenic elements, they contribute to perspective. The light level or intensity is much less than the key light. They would be used in film lighting much more

than in television because of single angle shooting. Where there is a lot of movement on set they tend to get in the way and cause more problems than they are worth. The luminaries are normally Fresnel type small spots with focus set to wide angle and use the barn doors to mask any spill light. Extreme care is needed to keep out any unwanted highlights.

Eye lights or Kickers

Eye lights are extremely important and should be seen in almost every face in close up as they produce very much more interesting faces by making the eyes sparkle. They are widely used in motion pictures and stills photography. For fixed positions such as sitting in a chair for an interview situation it would be quite normal to place a 100 watt dinky on a stand and aim at the face to get a reflection from the eyes to the camera, that is if the key light is not low enough or at an angle to produce a reflection in the eyes to camera.

Special eye lights take on various forms, such as circular ring lights made out of circular lighting rings the colour temperature warm at 3100 deg Kelvin or cold at 5000 deg k, colour filters and diffusers placed in front of these lights make interesting variations, The effect is to produce a circular eye light reflection.

There are some special Quartz Halogen versions, which are made to order by small lighting workshops. Various shapes could be used for interesting eye light reflections. One must be careful not to upset the scene with shadows cast from these luminaries and seen in the distance from the subject; the intensity of the lamp must be adjusted to suit the situation.

Small luminaries well diffused may be fixed to cameras on a switched dimmer circuit. Another variation is to use a soft light with a gobo or cut out to make a shape for the eye light and for very little cost. Too much light will also change the contrast of the face so be aware of the changes taking place when you introduce eye lights.

Backlight

The term “back light” is most descriptive of both the location and function of this source of light. It provides instant perspective setting the object or person apart from the background.

Lanterns are placed to the rear and above the camera view to avoid flares into the lens, the ideal angle from above is less than 45 degrees or a lower angle makes a better soft rim of light to the head, shoulders and arms, if flares into the camera lens become troublesome a flag arm or gobo may be used to keep the back light from entering the lens, steep angles above 45 degrees are to be avoided if possible as they become more like top lights and create unattractive highlights on the forehead, nose and ears. Normally the back light intensity is about 75 % of the key light when it is not being used as a rear crossing key light as in many television situations the back light is actually a cross key, there will be other back lights within the set depending on the positions of the artistes. This is not such a problem in film productions, as you would try to avoid this situation by stopping and resetting the lighting. In the continuous action inherent to television production back lighting is often planned to be dual purpose for the many reverse angle shots across the set due to the rapid shifting of cameras about the set. These multiple uses of light sources impose problems of positioning luminaries and intensive overall lighting balance control avoiding hot spots due to sources crossing is quite difficult and it comes back to outside rehearsal planning to get the position of the artiste's right and allow lighting to have a say in these artistes' positions with the director. This approach is often more satisfactory and visually more effective than trying to compromise the lighting.

Artists with baldheads need corrective make-up to stop backlight shine and backlights should never light the side of the nose, it would be very ugly. For seated persons two or more backlights may be used to rim light the subject. I often used amber gels in the backlights to reduce the blue white effect on heads especially against blue Chroma-key backgrounds used for inlay effects.

Top light

Top lights are normally placed overhead, and may be used to dramatise the stage setting or add to the overall fill light level by 25 – 45%. Helps to fill in shadows produced by dressing lights and key lights the overhead top lights could be hard or soft lighting. A favourite in film studios for overhead fill light is the “Japanese lantern” a bag made of white canvas with 2 or 5 kilowatts of light bulbs inside it.

Set lights and Dressing lights

These are used to decorate the set, to accent, model, or highlight the scenery and create effects such as the sun, moonlight, or outside street lamp, throwing light into the room through a window.

Separately controlled illumination of backings seen through a window, or the feature fireplace inglenook, sideboards for storage, a table lamp a kitchen scene, silhouettes horizons shrubbery and trees in the backyard the patio area day or night. Set lights are used to dress the walls of the rooms; this is all done without the main fill light being switched on, so one may see the results as the lighting is adjusted for best artistic effect. Shadows cast by the key lights and backlights may be dressed out with set lights. Great care is taken to ensure these set lights do not take away interest from the fore ground, the results should appear natural, if there is a window to the right and left of the room sunlight may only come from one side. Try to achieve one set of shadows in one direction only. Colours in the dressing lanterns can create a very different feel to the atmosphere of a room it may be cold or warm.

Overheads or Butterflies

Large Frames covered in muslin suspended above the setting and lit entirely from above, also used on outside locations to remove direct sun light from the subjects being filmed. These would be completely out of shot of the camera and most likely suspended from an industrial crane.

Follow spots

Operated by skilled persons they provide a useful key light on the theatre stage, or Pop concert stage, or nightclub scene involving a one person act, or a two person act, the problems come when two follow spots overlap whilst this is ok for an audience it causes a problem of increased exposure and is not under control unless the operators have the good sense to stay apart or they may have in the filter position a side scrim for left and right. Theatre follow spots are often operated with many different colour gels, the important thing to remember is to make sure all the right filters for your production have been tried and tested beforehand and unwanted ones removed. It is always best to have another person under your control, issuing the commands to the follow spot operators during the takes or transmission. That

person must know all the filter numbers in use to be able to call them up as required during the production.

The Super Trouper

Dc arc lamp is a high power spot for distant throws of 100 metres at 100 foot candles incident with a 3 metre diameter light circle, the need for more than one spot is simple, at some time in the production the carbons will need changing and this puts the spot out of use for at least half an hour due to the heat, it has to cool down to change the carbons. Conventional incandescent or Quartz Halogen spots, and H M I type spots should be selected with care. Theatrical effect is a hangover from early theatre that used a spot light for comedy theatricals directing attention to the star performer.

In television this point is made very clear by taking a close up of the “star.”

The colour temp of any follow spot deserves careful attention because they are fitted with a filter box and stray gels may be left in from the last production, it is best to remove gels that are not to be used.

Do not try to dim a follow spot, use wire mesh screens, each one is about 10 % loss and should not change the colour temperature. Each spot normally has an iris to open the light and shut it down this generally controls the size of the circle of light. Some spots are fitted with a soft edge iris as a second control.

Micro-Set

Lighting system by L T M. USA this is an HMI fibre optic system which provides various light sources through fibre optic cables to distribution lenses of various types which are very small and compact, these fittings are used for lighting inside vehicles whilst filming on the move. The light source is mounted in a box placed in the boot of the vehicle and is powered by a battery source, the fibre optic cables plug into the box to collect light from the source. Key-lights, backlights and soft lights are provided in the many types of fittings.

Coffins

Various forms constructed for special applications, (they are similar to billiard table illumination) but the performance in film studios is very different as the amount of light from the sources contained is very much higher. They may consist of a frame 2 metres by 1 metre with say a quantity of 1 KW linear QH bulbs attached to the frame facing downwards and a cloth drape pinned around the frame edge about a metre in drop length, this may be a black skirt or a white skirt. It must be constructed with good ventilation to avoid any fire risks. 5 K and 10 K versions are common. They are used as overhead top diffuse lighting for very large areas.

Hancock Flicker free soft light

Produces daylight soft light from a high frequency operated bank of fluorescents the Hancock Flicker Free remote control daylight source is used as a useful soft fill light matching daylight colour temperatures alongside low power H M I lanterns.

Flying Moon

A very large cube of scaffold construction about 5 metres square covered in white muslin, containing up to four 25,000 Watt H M I s, which is hoisted up by an industrial crane to 30 or 40 metres above ground, it provides the light to create a night scene with an artificial moonlight effect.

Scrim

A scrim is a fabric that reduces lighting intensity. Scrim is made from acetate, acrylic, wire-mesh or glass fibre. Glass fibre is provided in rolls of fine, medium, and course material. Scrim may be cut to various sizes in squares or circles and may be one third or two thirds of a circle fitted into the lower half of a round gel frame, this reduces the level of light in foreground or foreground and middle distance. With the luminaire set at approximately 30 degree to the horizontal and used as a key light, the idea is to provide a corridor of even light in front of the luminaire so allowing a distance to foreground area to be at the same illumination level. Thus an artiste could walk from the distant point to foreground without any exposure change to that person. The amount of scrim used to achieve this result will vary according to the distance required and the height and angle of the luminaire. Wire mesh is an alternative and traditionally wire gel has been used for this purpose, it may also be mounted diagonally by rotating the frame. It may also be used as a softener or blender as a full scrim fitted to soft light luminaires.

Diffusers

Glass fibre translucent cello-glass, gelatine wire, silk type fabric, or acrylic fabric these reduce the lighting intensity and provide a shadow-less source of light. These are fitted in the frames provided with the luminaires; to produce a very wide angle diffused soft light, always used for soft lighting. Diffusers may also be fitted into spotlights in order to provide a very directional source of controlled soft light.



Lighting Stencil Instrument

Lighting Stencil Instrument to draw outlines of standard luminaires

The Stencil is intended as an aid to speeding up, clarifying and standardising lighting plots, the scale drawings must match the scale of studio floor plans, which in most cases are based on feet and inches and metric equivalents. Floor plans are normally marked out in square feet and lamp outlines indicate the space they occupy, these come as a stencil to draw the outlines, immediately it becomes obvious how space is gobbled up by luminaires when plotting positions. Lighting stands are also outlined as a triangle of a size to represent small lightweight stand up to the very large stands for arc lights. Another type of stencil shows the recommended optimised overhead angles for backlight, key light, and fill light and with full flood angles for various luminaires. Much of this information is available inside the manufacturer's luminaire catalogs. Once acquired the stencils are normally the personal property of the lighting person.

How to use the Lighting Stencils 1 and 2

The stencil is intended as an aid to speed up, clarify and standardise Lighting plots it contains a set of standard cut out symbols each representing the actual space occupied by each type of lantern and also provides diagrammatic information regarding beam spread and incident angles for a number of lanterns in frequent use.

The cut out sections allow for the pencil thickness when marking a studio floor plan and the scaled section $\frac{1}{4}$ inch = 1 foot, the outline allows for fixings but the length is not important for there must always be clearance in front of the lantern.

The eight cut outs A to H as follows:-

- A = Effects spot pattern 93, B = 5 Kilowatt Fresnel spot, C = 2 Kilowatt Fresnel spot
- D = 500 Watt Fresnel spot, E = 2 Kilowatt double broad (MR).
- F = 5 Kilowatt "Four light" For Cyclorama.
- G = Bank of four Scoops close to each other on the same supporting barrel.
- H = the remaining cut out is used to draw a line in the direction of the lantern throw.

- With reference to stencil 1 the angle X O Y is 44 degrees, this is the coverage angle of a fully flooded 2K lantern fitted with barn doors and standard Fresnel lens.
- The angle W O Z is 60 degrees and is the spread of a fully flooded 5K
- The angle U O V is 90 degrees about the average spread of a soft light source.

In the studio most scenery has a height of 10 feet (because of stock timber and plywood) If lanterns are slung clear of the tops of these flats, their height will be about 12 feet (average height) and allowance and consideration for the boom microphone operator who has to work under the lights.

The 2K spot light is probably the most frequently used lantern apart from soft lights.

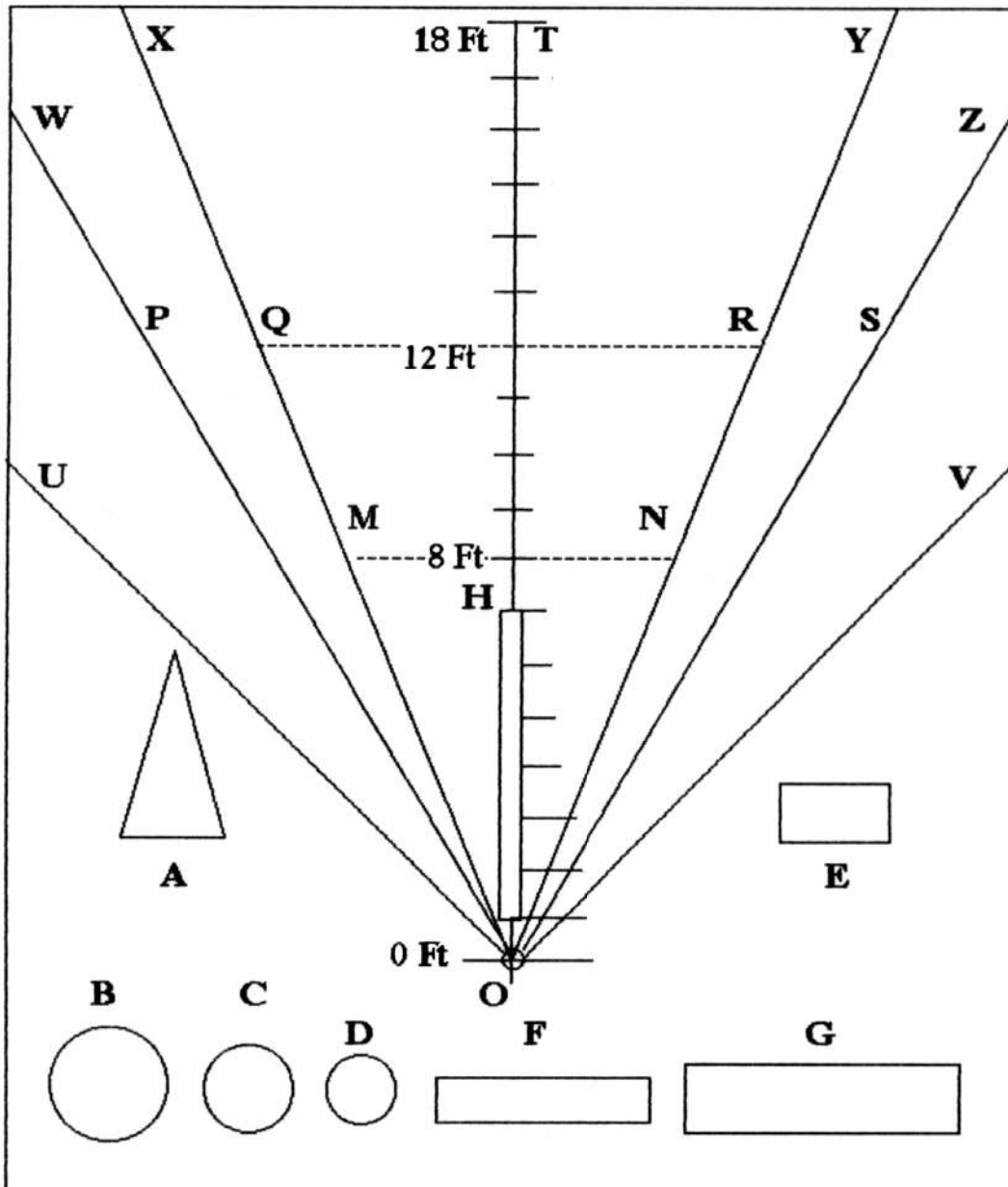

Lighting stencil 1 Imperial scale ¼ inch = 12 inches.

Therefore with a 2K slung at a clearance height of 12 feet the following conditions are desirable (but admittedly not always practical). Actors should not be nearer than 8 feet to the lantern (this distance measured along the studio floor) with an average height of the actor of 5 Ft nine inches the incident angle is at the maximum of 40 to 45 degrees, at a distance of 12 feet along the studio floor, from the lantern the incident light angle is about 30 degrees, at a distance of 18 feet the angle of incident light is too shallow and will cause shadows to be seen, this is called “dirty light”.

Hence these distances are marked on the stencil at 8, 12, and 18, feet by lines MN (8 Ft), PQRS (12 Ft), WXYZ (18Ft) intersecting lamp throw projection line OT.

From a series of measurements made on a “Strand Electric” 2K Fresnel lantern at full flood the average intensities are as follows (lantern height 12 Ft) and a light meter height of 5 Ft 9 inches.

At the 8 Ft mark on the studio floor) incident light = 160 Ft.c

At the 12 Ft mark -----= 120 Ft.c

At the 18 Ft mark-----= 70 Ft.c

By use of a “Window-light”(wire mesh set in clear gel) scrim material fitted to the scrim frame bottom two thirds and bottom third added, and by careful blending the intensity of the source can be made very even over the space length of 10 ft.

Walking the distance from 8 ft to 18 ft the average incident light level was consistently within 70 to 80 ft.c close enough not to see any significant variations of tonal face values, with a 1K Fresnel spot the level of light is about half the values given, this practice has been repeated with other types of wire scrims and lanterns with great success. The height may be increased to increase the distance of throw as required.

In practice the stencil is moved around the lighting plot until the area to be lit is covered and a line drawn in the slot “H” and the lantern outline drawn at the end “O”.

Example if a 2K spot is used at a height of 12 ft trapezium XMNY gives the area the lantern will cover. A line is then drawn along the slot “H” and the appropriate stencil outline drawn at “O” in this example use outline C for a 2K Fresnel spot.

Lighting Stencil 2

The second stencil shows elevations and cut outs for some other types of lanterns and has optimised key light and back light angles for given heights, and distances are in metres, it also allows for eye-line heights. The cut outs are as follows,

From left to right top to bottom:-

- 2K Broad, 5K follow spot, 2 K North light, 2K fresnel spot,
- 1K Broad, Pattern 93 f/spot, 5K Fresnel spot, 5K twister,
- 5K North light, or 5K four light (cyclorama), 2K follow spot, 10Kw Fresnel spot
- The bottom right square any 1 Kilowatt or lesser lantern.

- The dotted lines across stencil are the seated and standing average eye heights.
- Left hand side angular lines are set for 30 degrees key lights
- Right hand side for backlights optimised at 40 degrees. Always try to keep within the recommended angles for backlights and key-lights for consistent results.

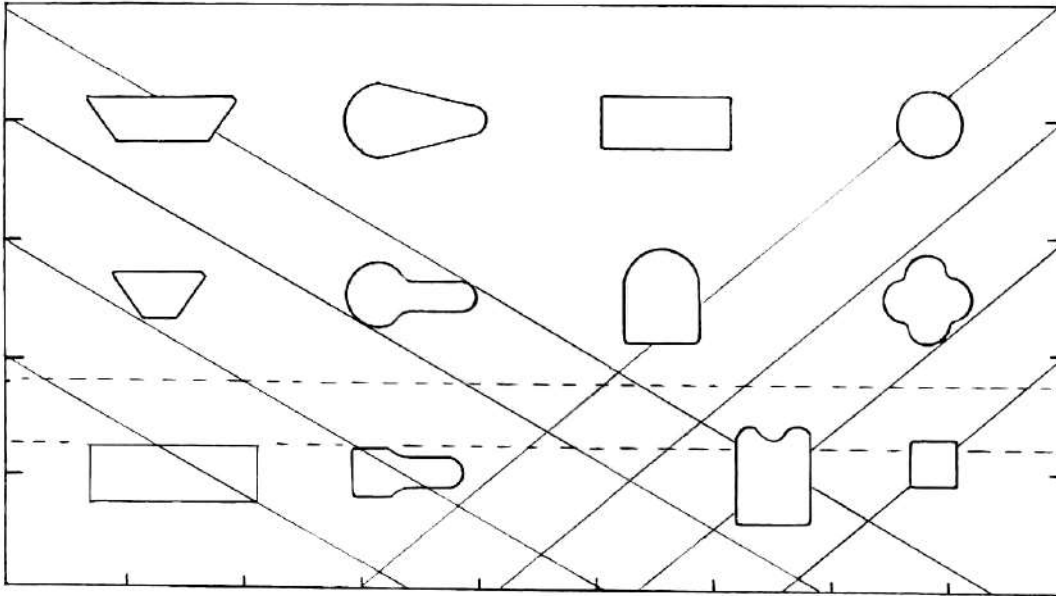

Lighting stencil 2 Metric full size, scale marked in metres at the edges

How much incident light is required?

For film this will depend entirely on the choice of film stock and a suitable “F” stop for the lens selection, a wide-angle lens at F 4.5 or a telephoto lens at F 8 allowance must be made for the required depth of field. The distance between the nearest focal point and the furthest away point this may or may not be infinity. A tape measure will be used by the “focus puller person” to establish these requirements and the lenses are selected to match. Incident light levels that may start at 100-ft.c and could range up to 500 ft.c depending on the individual requirements. Film speeds of 50 ASA up to 800 ASA may be used for motion film (grain size of the emulsion gets bigger as the film speed increases), the selection of film speeds also depends on what action is involved, Drama studio, Out-side location, Stunt action, etc. Stunt action often involves multi film camera positions.

For television studio productions a general figure of between 50 ft.c up to 250-ft.c would cover most situations, F 5.6 on a modern colour camera with a 10:1 zoom-lens could operate with 50 ft.c very well, a 16:1 zoom would require at least 75 ft.c at F 5.6. If the cameras are 10 years old or more they may need 50% more light. The current range of zoom lenses for TV, have a very large depth of focus and have better F-stops, which allow cameras to operate at lower light levels.

All broadcast colour television cameras have zoom lenses for studio operations and outside broadcast, only hand held cameras may have interchangeable zooms and fixed lens. Most hand held cameras use 16:1 zooms and with a switched electronic sensitivity control and are able to make pictures at approximately 1 ft.c incident light, which is suitable for Electronic news gathering, “ENG”.

For both mediums film and television the same lighting equipment is commonly used, there are some major differences with very high-powered lights used more on motion pictures than in television. It depends on the location and individual requirements as to the selection of lighting equipment.

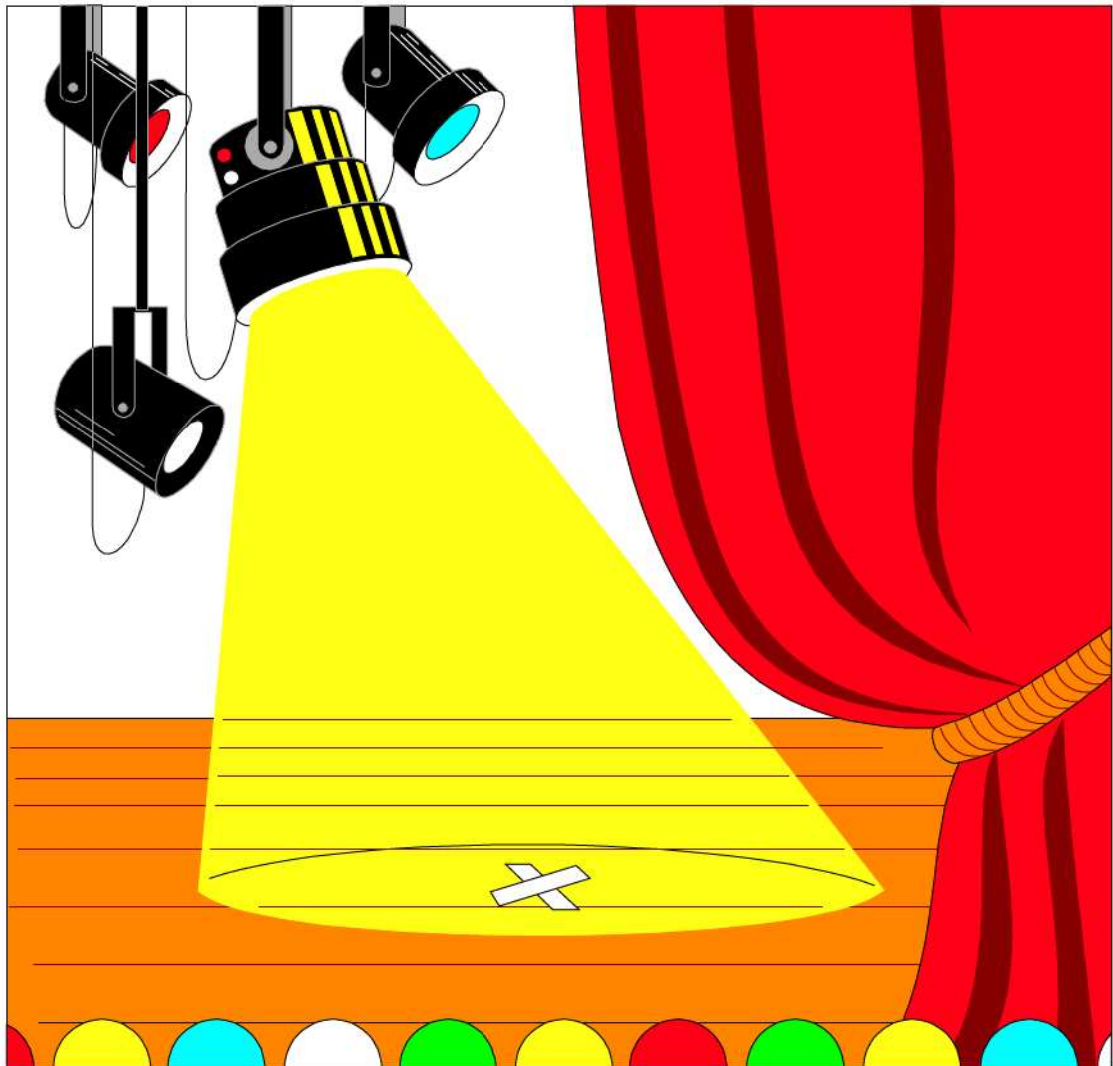

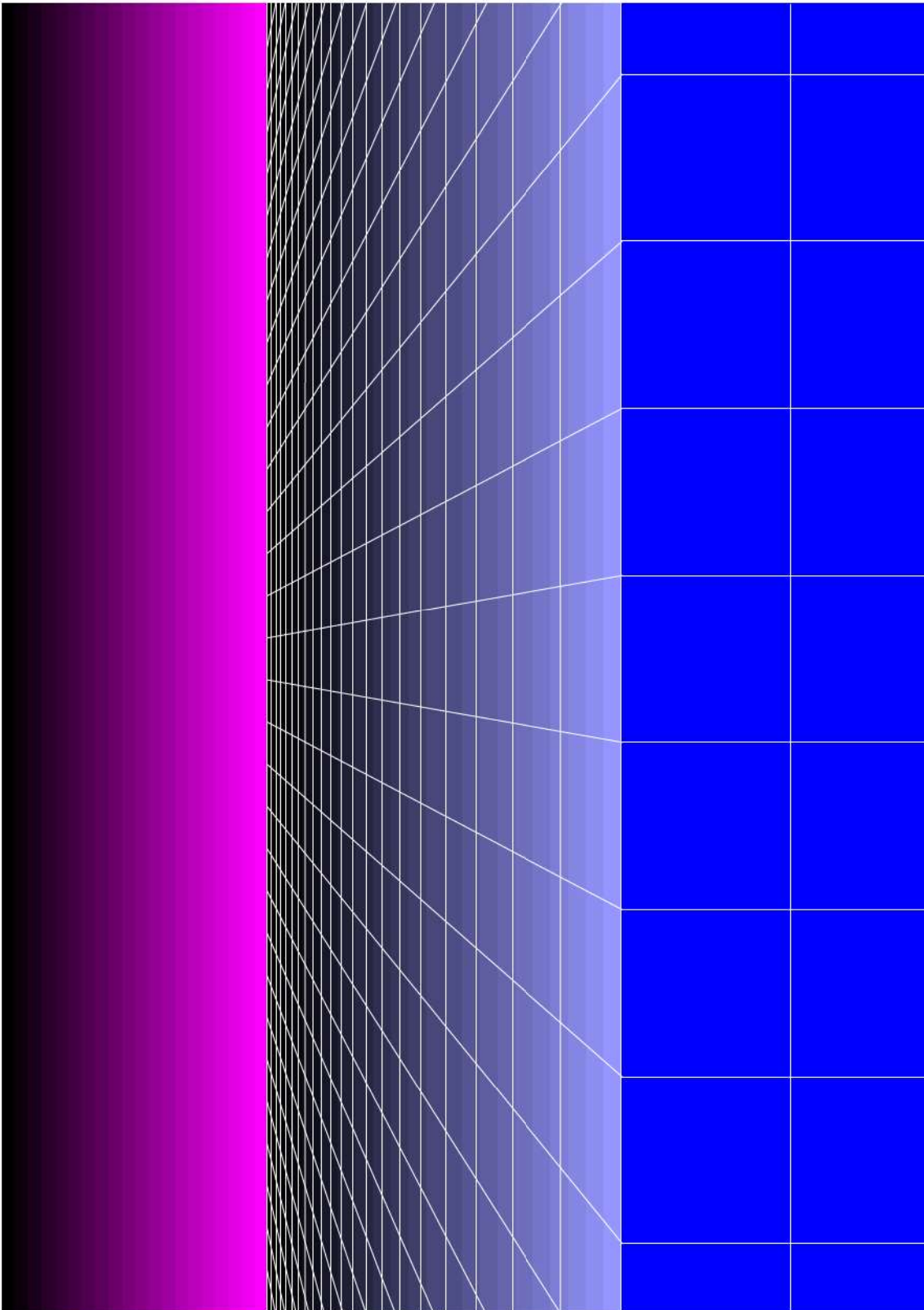

Introduction to lighting plots

The lighting plan uses the Set Designers floor plan with a sheet of tracing paper laid over the top; the lighting plan is then drawn using symbols from the stencil to indicate the various types of lighting equipment to be used and the area the lantern will cover. Scale stencils of various manufacturers Luminaires or Lantern shapes, Drawn on the plan would be noted for their control numbers, the colours, the type of scrims, and any special accessories needed along with the position of the lantern and the height. Cross Sectional drawings are very helpful and essential for theatre productions though not used much in television Studios. There are no standards to the colour codes used in each Individual lighting plot.

The lighting plot (basic three point lighting plot)

This is a plan view of the studio floor for the purpose of explaining the general relationships or positions of the luminaries the scale is not important in this example.

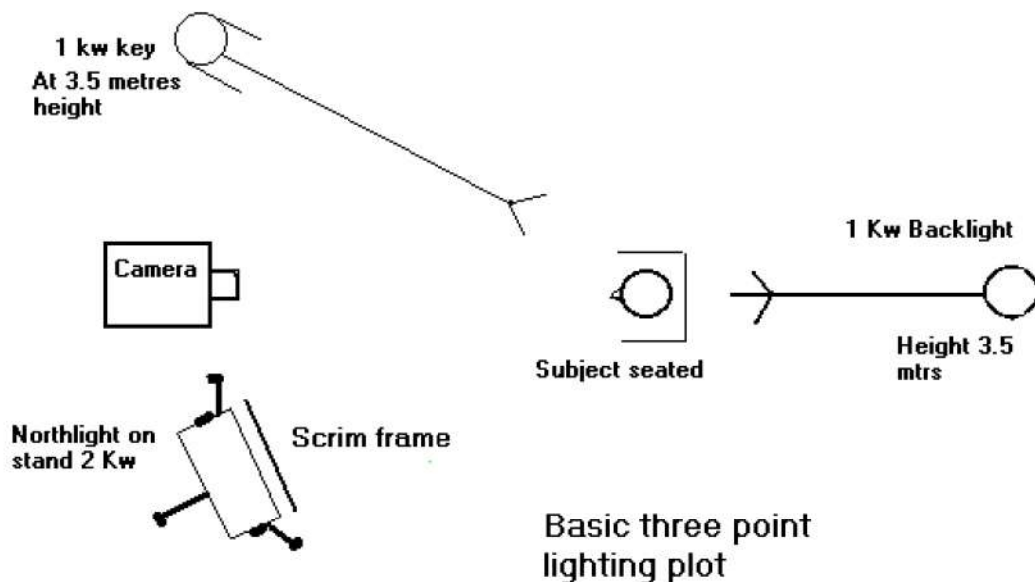

Basic three point lighting plot fig 1

The heights of the luminaries and the angles from the horizontal are very important, the angle between each luminaire has a special relationship to the facial shadows, the key-light is about 30 degrees to the right of the subject's eye-line to camera, and about 30 degrees above the eye-line to camera. The nose shadow should fall within the cheek/nose line and must not cross the mouth. The left hand side of the face is in shadow until the fill light is switched on.

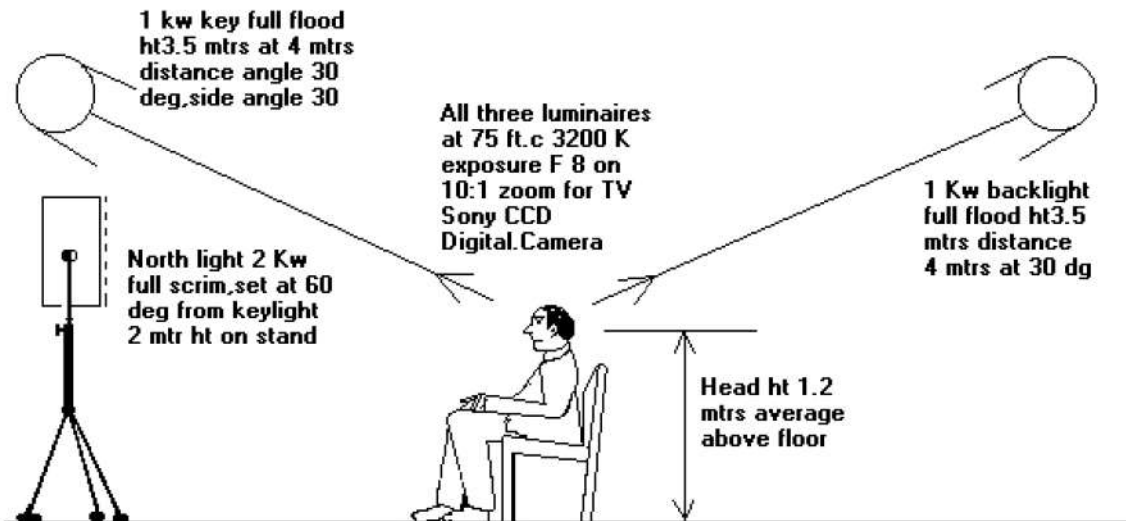

Lighting elevation 1

This refers to the basic lighting plot

Lighting elevation 1 of fig 1, Fig 2

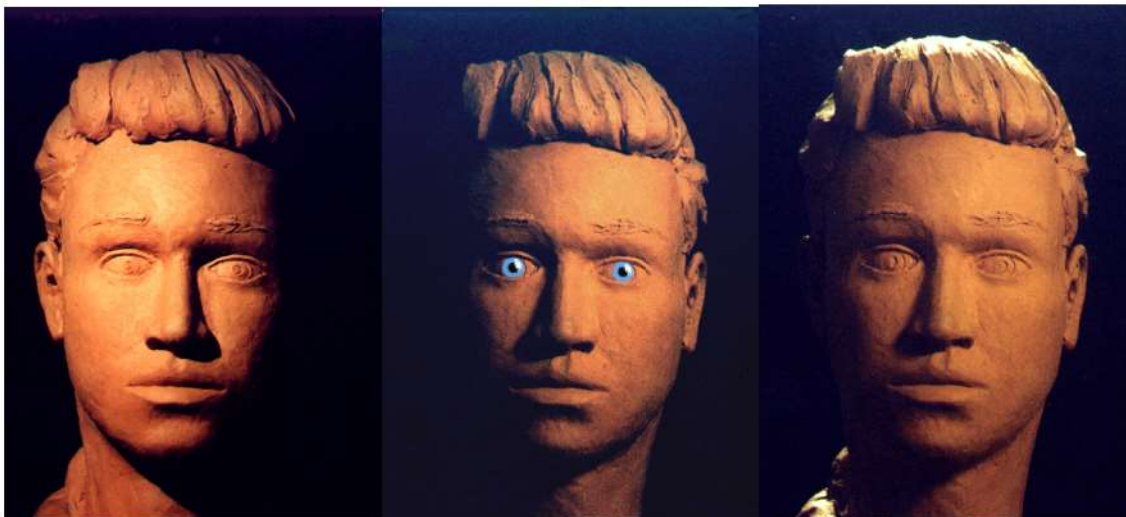

Key-light only

Fill light only

Fill light and backlight.



Key-light & backlight

Key-light & Fill light

Key, Fill & backlight

Use a light-meter to adjust the distance of the fill light for 50 ft.c on the face, the key light should be set to give 75 ft.c incident light on the RHS of the face this is done by changing the focus, from full flood towards the spot end of the focus control, until the level is obtained. The backlight should be on full flood and measure approximately 70 % of the combined key and fill-light. The backlight should be no more than 45 degrees to the horizontal the ideal is between 30 and 40 degrees to the horizontal. Barn doors should be set into a square trim box to avoid flares into the camera lens.



Lighting plot 3 fig 5, showing the results of crossed keys at 30° from the rear, providing both the key-light and the backlight for the seated positions at the left and right hand side. The fill light is off; note the texture and the deep shadows with little or no details.

Lighting plot 3 fig 5, In this view the fill light is on, note the shadows are reduced with the addition of the soft light whilst retaining the details on the surface.

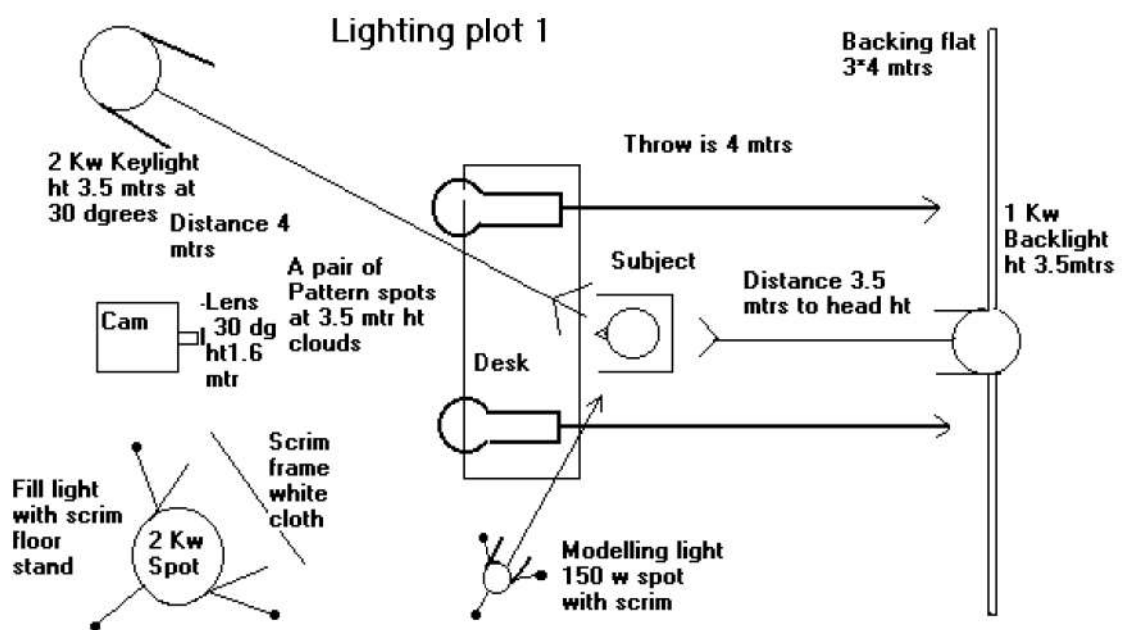

fig 3 lighting plot 1

Lighting Plot 1

Within this plot are added two pattern spots to project a bright cloud effect onto the white backing flat 3 metres high by 4 metres long. The spot width is 30 degrees by 20 degrees high governed by the slide format, the light level is 80 ft.c incident at the backing. A modelling luminaire on a stand has been added; the light level is adjustable from 20 ft.c - 80 ft.c.

Instead of a North light, a 2 K spot at full flood is positioned behind a 1.5 metre square fibreglass scrim frame the light level at the subject should be 150 ft.c of soft light.

The key light will produce 200 ft.c of incident at the subjects face, and the backlight may be adjusted to 150 ft.c. The camera lens will now be operating around F 16 and the depth of field will include the subject and the background in focus. There will be spill from the soft light on the backing. The key light should have the top barn door pulled down to miss the backing. The backlight confined to the head and shoulders to prevent a flare into the camera lens. This was a typical set up in many presentation studios both in monochrome and colour.

Two Person Interview (dramatic interesting faces -crossed keys)

The interview set up is extremely simple and makes use of each key light providing backlight for each and opposite person. Each key light is set to provide about 75 ft.c incident on each face, and about 50 ft.c as the backlight by the use of a half fibreglass scrim fitted in the lower half of the luminary's scrim frame. Without fill or soft light the results are dramatic. Lighting with varying amounts of fill light reveals interesting details in the faces and with care may be varied during the transmission or recording process.

In Lighting plot 3 Fig 5 a more sophisticated version of plot 2. The key lights are moved to an angle of 15-30 degrees to the subjects, the scrim frames are rotated to a diagonal position. Fill light is absolutely necessary as there would be no light for the wide shot on camera 3. With the key levels set for 75 ft.c the fill light should be 50 or 60 ft.c this may be set by use of double scrims or single scrims in the North-lights depending on the chosen position 2 to 3 metres away from the subjects. Both key-lights should be at full flood and focused to obtain

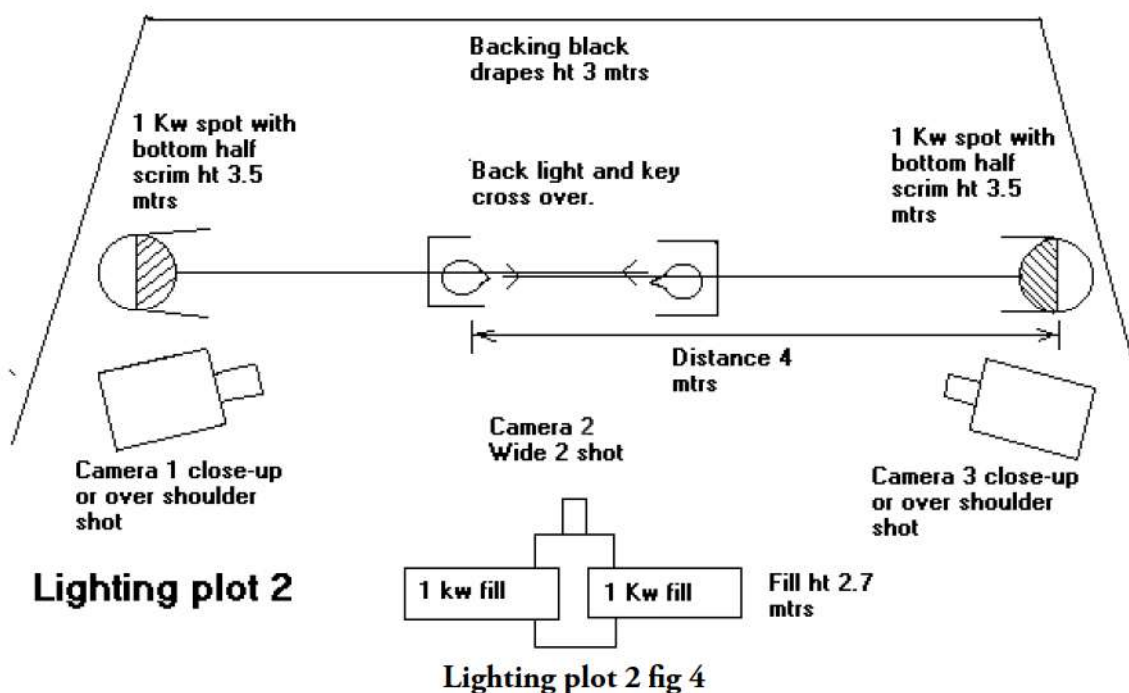

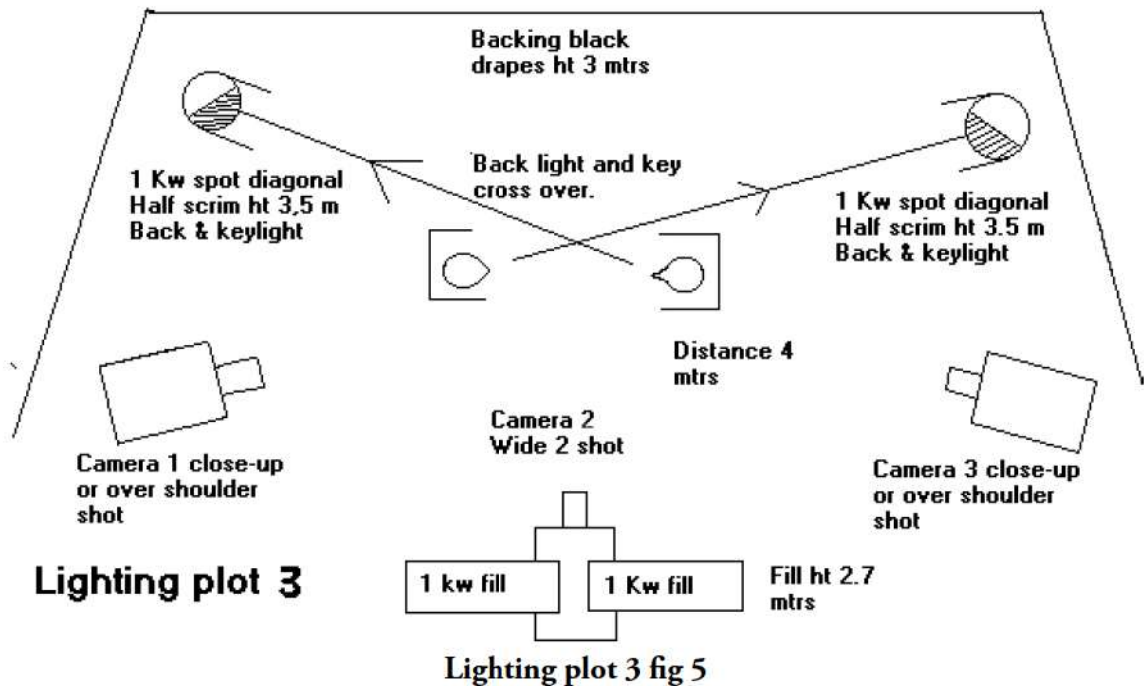

75 ft.c of incident light. As this all takes place against black drapes spill light will not be seen by the cameras as it will not be reflected back, but it is always good to be tidy with light so confine it as much as possible the electronics in the camera may provide some electronic black crushing if required to make the background totally black.

If this were to be shot on film you would need slightly more space between the black drapes, the subjects lifted up in height by the use of a rostrum, the film camera could be mounted on tracks, most likely the lighting levels would be quite different.

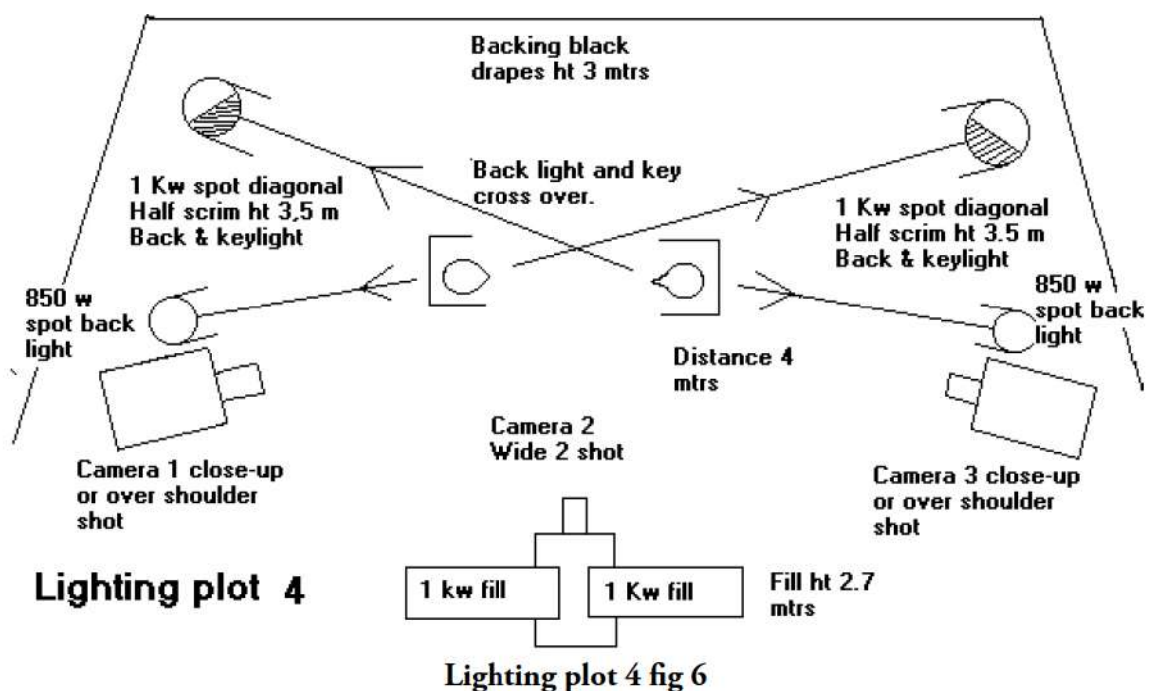

Lighting Plot 4

A further variation to improve the back lighting, every thing else is the same as plot 3 but for the addition of two back-lights, from camera 1 and camera 3 the close-ups would not have evenly distributed backlight so by introducing the extra luminaires this imbalance is corrected, the levels of the new backlights must be adjusted to the same incident levels as striking the shoulder from the cross key back lights.



One cross key-light only,

Key-light, backlight, & fill light

The floor plan, Fig 6, shows the two cross dual-purpose luminaires to the top of the plan and the addition of two backlights either side. The fill light (centre) is only 2 metres from the two subjects and is tilted down at 45 degrees, All the barn doors are tight boxes to reduce spill light, and this keeps most of the light concentrated on the subjects, which gives the area a feeling of close ness, the cameras are not as noticeable to the seated persons as they are moving in the surrounding darkness. Three camera angles are shown as examples for close-ups, over shoulder, and profiles or wide two shots.

Rear screen projection

As with all projection systems the screen is brightest when viewing on the central axis so the best place to put the camera is on this axis, the light levels to be expected are always disappointing, never the less there is enough latitude within both film and television cameras to cope with the low light output from the screen.

Back projection with a presenter or news reader standing in front of it requires careful lighting, the key light should never light the screen and the presenter must not be less than 2 metres from the screen and lighting a person this close is difficult enough, so we would always prefer more separation but we are seldom allowed it.

In Figure 7 the key light is arranged at a rather acute angle to avoid the screen, and very little fill light is allowable, in order to fill the shadow side of the face we introduce the side kicker at the extreme left by balancing the light levels of the kicker and key we get a reasonable feature face which is acceptable. Dressing lanterns need to be positioned to avoid lighting the screen with direct light or spill light. The choice of back projector decides the lighting level to be

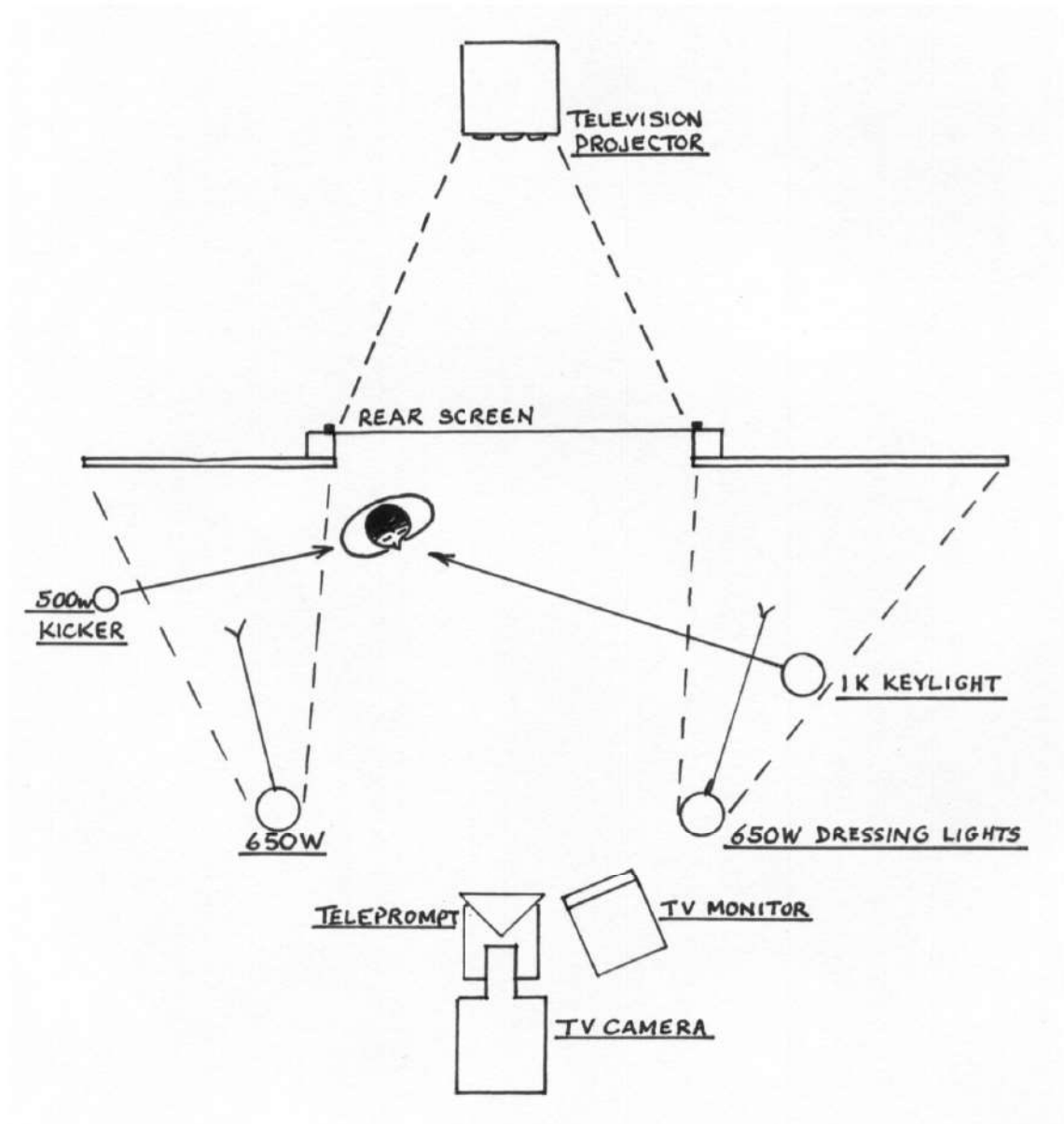

Fig 7 Rear projection lighting plot

used, as any highlight projected onto the screen would need to be about one stop above the face tone.

With 1000 Ft lamberts of highlight brightness the key light would need to be about 50 ft.c incident lighting, taking into consideration the transparency of the screen and a reasonable F stop for the camera. This situation requires a spot meter to assess the levels correctly.

Chroma key

When viewing Television and you see the weather person or news presenter on your screen you will more than likely be watching a Chroma key scene within the program.

Fig 8 Shows a typical Chroma key set up as a lighting plot, the presenter is standing about 1 metre from the scenery flats to the left hand side of picture frame, and the Chroma key painted background is behind the presenter.



Example of rear screen projection from a slide projector

The camera is fitted with a prompt reader system which is seen by the presenter when looking directly into the lens of the camera, positioned below the camera lens or suspended above the lens is a transmission monitor for the presenter to view the keyed picture to which references are made by the presenter during the transmission of the program. Chroma key is a method of electronically inserting a different picture behind the first picture layer by the use of a colour to separate the two layers. The presenter must not wear cloths of the same colour as the backing! Scan reversal left to right may be provided on the presenters monitor to orientate his or her movements.

A weather presentation is normally recorded to avoid any errors and does not go live to air. News programs are normally presented live on air with pre-recorded inserts.

The lighting is very simple; the basic three point lighting plot (fig 1) is repeated here in Fig 8 with the key light, backlight, and soft fill light plus the set dressing lights for the Chroma painted screen background. The two 2K/1K north lights provide an overall base light and fill light for the presenter and the setting, the light level is about 50 ft.c incident for the presenter, the 1K key light is focused to provide 75 ft.c incident onto the presenter and the side barn doors adjusted to keep light off the Chroma key backing, A 2K lantern to the right of the key light has a right hand side wire scrim to help even the light falling onto the Chroma key backing the focus adjusted to provide approximately 45 ft.c. This plus the spill from the soft light will be about 50 ft.c at the right hand side of the frame. The task is to get the Chroma key screen evenly lit and to keep the level of light low in relation to the presenter for this reduces the colour bounce back effect from the backing. There will be a double soft shadow of the presenter falling onto the Chroma key backing but this should not cause any major problems for the electronic picture switching effect, which inlays the background in place of the Chroma key screen backing.

The most frequently used colours for Chroma key backings are blue or green (sometimes yellow may be used) this paint is specially prepared and has a high reflective index.

With a blue backing the coloured light bounces back from the surface and lights the rear or side of the presenter's body, in attempting to control this I would gel the backlight with quarter CT orange which should counteract the blue and helps to make the electronic key work much better for the presenter's outline, much reducing the electronic ragged edges on the final picture.

Which ever way you choose to illuminate a Chroma key backing, it is most important to get the light levels as even as possible, the use of a spot meter is vital to this process. The camera must see a perfectly even surface of Chroma colour and by placing the spot meter at the camera lens position the evenness of the reflected light may be measured accurately and some adjustments to the lanterns are made to achieve this.

See photo 30F - the green background is not even! But the electronic key switching between the green background and the inserted picture still works with ease. As seen in the "Off Air" picture.

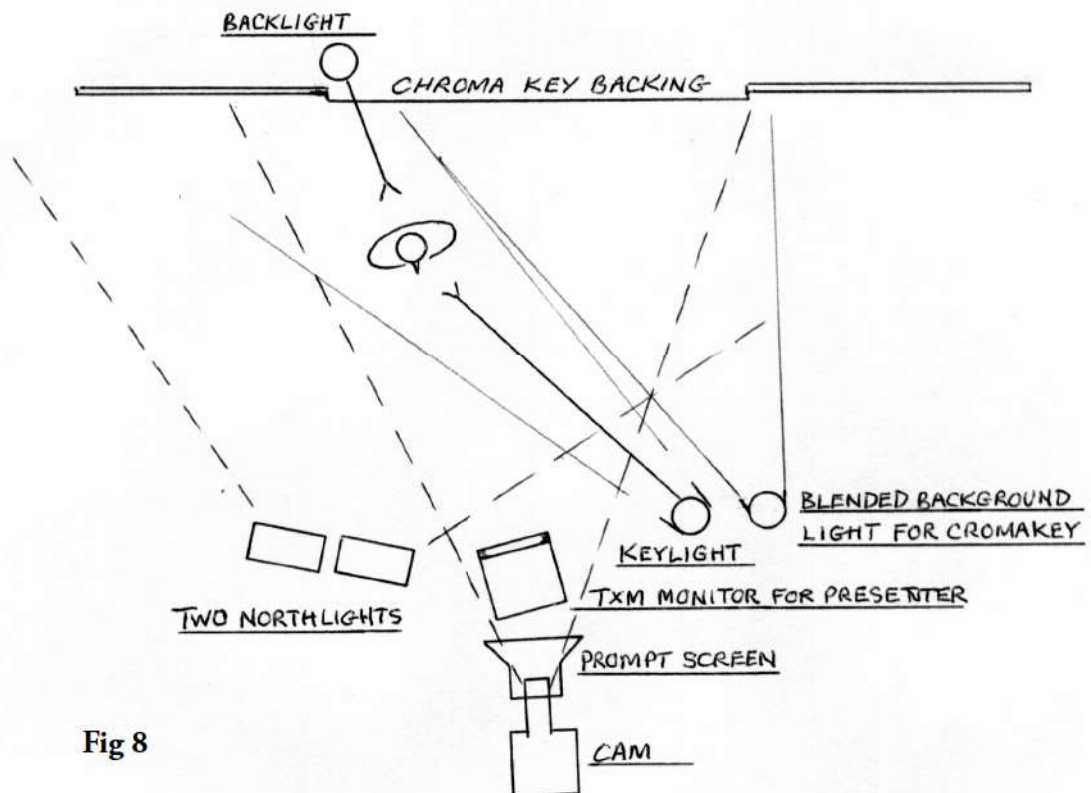
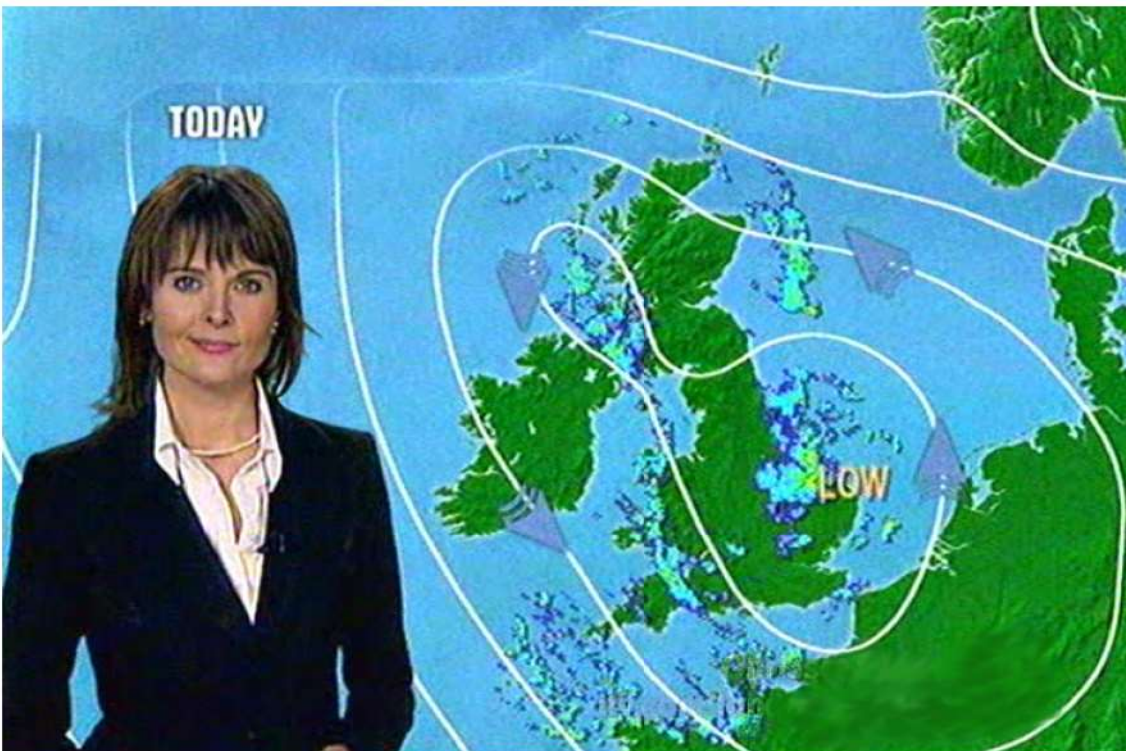

Fig 8

The LNN Studio set-up is slightly different to the plot shown here in fig 8 and achieves the required results. The background is not lit as evenly as I would like it to be because the key light is causing a lighter area in the middle of the picture.



Photo 30F - LNN Studio picture seen by the camera as a Chroma Key background with Chrissie Reidy standing in front of the green backing whilst she presents the weather report.



The off air monitor picture showing inserted weather map electronically replacing the green background of the Chroma key area



This picture is a digitised version of the studio camera picture showing the clean and even green background for inserting the background weather maps.



The London Studios, Upper Ground, London, SE1 9LT.

Lighting people against a bright window

Fig 9 shows a presenter standing against a bright window and we need to get our exposure on the face and balance the contrast ratio to within reasonable limits for our Daylight film, which is rated at 400 ASA, at 24 fps, so for a lens aperture of F16 we need 250 ft.c incident light level on the face, if we go to the window and measure the level of day light penetrating into the room and find it is 500 ft.c then this is the equivalent to f 22, so the light from the window is one F stop higher than the light on the face the maximum comfortable exposure for our film without bleaching out in the whites. The quantity of light on the face should not be less than 3.5 F stops below the brightest area of the window for a comfortable exposure.

Next we measure the darker area of the lower wall behind the presenter and find the light level is 62 ft.c this is over three stops below the level on the face, this will look quite dark in the picture and if there is some interesting detail to be seen I would give this area additional lighting to a level 125 ft.c about 1 stop below the face tone.

Should you find the window is very much brighter there is a need to provide some neutral density gels over the entire window and perhaps some colour correction gels?

Raising the light level inside with H M I lighting begins to cost money so neutral density becomes the more obvious choice. But if you are inside a Cathedral you may not be able to get to the windows, so the alternatives are avoid putting people in front of windows or spend the money and light the place with H M I lanterns to what ever level you need. In fig 9 the dotted circles are areas to measure light levels.

A spot meter is ideal to assess the contrast ratio and the exposure range for the above situation because you may not be able to get to the inside of the windows, the spot meter can view them at a long distance because of the very narrow angle.

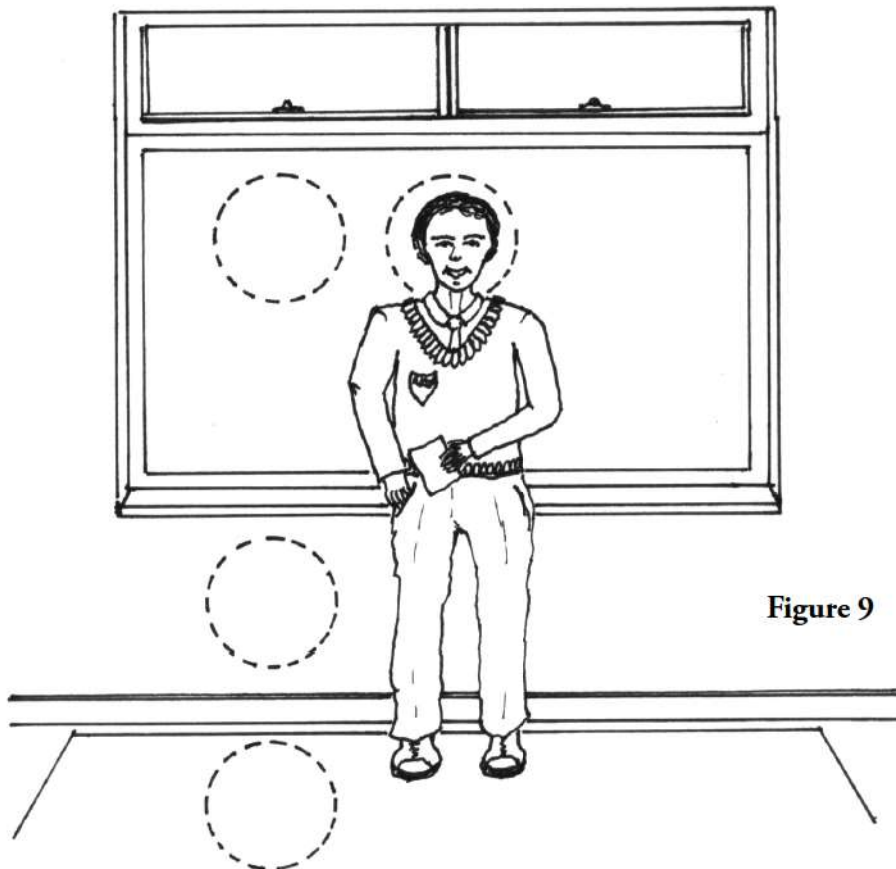



Example of “Man against window”, 250 ft.c incident key-light level at 5400 K, the outside light level 500 ft.c Day light at 5400 K. Film stock Fuji 400 ASA F16 at 1/30 A CCD digital television camera at F16 at 25 FPS produces the same picture.



Example of “Man against window” This time the key lighting is tungsten at 3200 K, daylight film is used at the same exposure, the mismatch of face tones are very obvious and the previous white window frame is now red tinted due to the mismatch in colour temperature. Correcting the film to get the face to look normal would make the outside daylight scene look extremely blue.

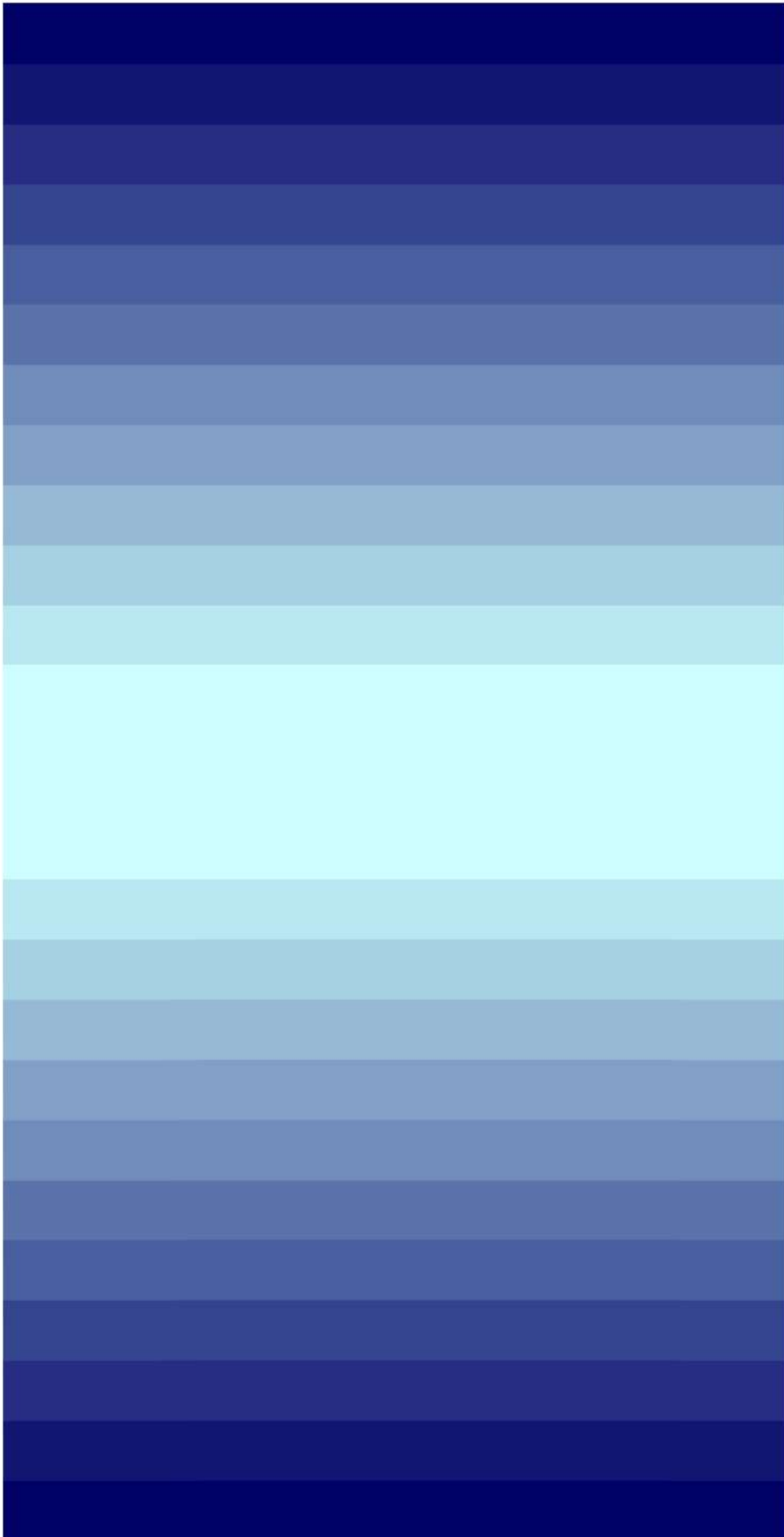

Gobos and flags

Solid shaped pieces of plywood or black card or shapes cut out from material, sometimes supported in a frame hung or supported a short distance in front of the dressing lights or key luminaires to MASK OFF some area of the stage or object being illuminated, or to prevent casting shadows of the boom micro-phone onto the setting or artistes in the acting areas. A ball on a piece of string could cover one annoying highlight by carefully positioning it in front of the offending luminaire.

Cucolories or cukes or cut-outs

Cut out patterns and shapes in a solid material shield hung or supported a short distance in front of a fresnel luminaire permitting a shaped pattern of light to pass through the openings and to project onto the cyclorama or scenery. Projecting alphabet letters, or Venetian blinds, or any design of your choice. The average distance in front with a 2 KW lamp is 1 metre, a snoot or top hat fitted to the luminaire or a set of barn doors to stop spill around the edges of the Cuke. To reduce splash back light from the surface of the cuke it should be made of matt black material.

High Hats or funnels

Metal tubes the same diameter as the fresnel lens of the luminaire to fit the second slot away from the lens. They are provided in various lengths and tapers reducing the field of light. And are used to stop spill light from the lens illuminating nearby areas where such light is undesirable.

Colour filters or gels (Heatproof and flame retardant)

Colour gels fitted to luminaries provides the studio production with colour changes to backings and scenery, cyclorama, audiences, and objects. Select from hundred's of colours available, gelatine or heatproof Acetate "Lee Filters" or "Rosco Filters". Match your artiste's gowns with complementary colours for light entertainment. Gel frames are provided on all fresnel luminaries, and should be kept in place in the first slot next to the lens.

Umbrella soft lights used as main light source

Dealing with eye lights brings us to the use of umbrella lights used by photographers who use both to produce fashion pictures, when lighting for "Pop" promos many variations of this type of lighting have been used to great success for film and television. Umbrellas work as huge circular sources of light and are used as the key light and often the only single source of light, as the backings are often a large roll of plain or coloured paper the spill from the

single light is enough to light the backing. Another way to use umbrellas is to shoot against a Chroma key or travelling matt background which is lit separately to get the background as even as possible, and separated by some distance so that colour spill does not effect the artiste or the lady model in foreground. Eye lights and modelling lights may also be used. The umbrella light will be just above the camera lens and the reflection from the eyes will be the dominant umbrella if the artiste is looking directly to camera. This kind of lighting is very flattering to the human body or nude model.

White sheet Gobo lighting

This form of soft lighting is for very large areas and could cover a whole scene setting or stage area. It consists of a huge linen sheet hung from a horizontal bar suspended so the bottom edge is about 2 or 3 metres above head height, the cloth could measure 2 metres drop

by 10 metres in length and behind it could be placed Fresnel luminaries of power values to provide the level of light required. Barn doors adjusted to keep the light only on that side of the sheet. What comes through the sheet is an extremely soft light and is often used in advertising motor vehicles and very shining or glossy objects.

Reflectors and reflected soft light

A form of very soft light source to be used as fill light could consist of a sheet of white paper, canvas, or polystyrene. A luminaire is focused onto the sheet and the reflected light is used to provide the fill light, which is by nature a very soft form of illumination.

The reflectors used for outside location filming, may consist of many different types of materials, Use your Lee reflectors, Filters, and gel Samples to select an appropriate reflector material as there are quite a lot to choose from. There are special circular fold up frames with plain white cloth and they may be hand held under the face of a presenter or to one side as required, assuming the sun is behind the person directly in front will do. Some reflectors are large frames with options on reflecting surface and may be used to reflect sunlight note the warning.

“Hazard Warning” never use plain mirrors or polished aluminium surfaces as reflectors with sunlight, it can blind people’s eyes. Common reflectors recommended are white matt, crinkled aluminium, Silver cloth with various sized surface holes to allow for differing reflective quality.

Projectors displaying patterns or pictures onto plain backgrounds

Slide projectors for 35mm positive printed slides, generally used in semi darkness for people to see them, not bright enough for large areas and any stray light reduces the contrast. Cinema projectors cover very large area screens but must be viewed in darkness, increasing the lamp power in the projector produces additional heat, which would melt the slide, air blown across the surface of the slide plus heat proof glass used to isolate the slide stops the slide from melting, but the limit is soon reached when no more brightness of the image is possible.

Effects lights

There are many types of effects luminaires available, a brochures from the lighting hire companies will supply the details and hire prices as requested.

However for effects lighting there are special slide projectors with MSD bulbs such as the MAC 500, rated at 575 watts or others with QH bulbs rated from 100 watts to 5000 watts and have various slide adaptors and colour wheels which may be fitted as required, these are often used to paint white backgrounds and as example to create moving beams of coloured light or a cloudy sky behind a window either moving or stationary.

Miscellaneous light sources

Solenoid controlled dc arc lightning flasher to create lightning effects. Puts clicks on live sound so be aware. Used in film studios seldom used in television.

Flame light silk cloth and vertical fan with a light source in the base.

Flame-projectors, Cloud-projectors, and Patten projectors.

Hand torches, Coach-lamps, Headlight sets hand held in the distance for effects at night, Rotating lights for lighthouse or police vehicle.

Flashing or lit neon signs with special R F transformers that do not cause interference to the sound system. Pin-ball machines, Game-machines and Christmas tree lights. Curtain Star effects, uses glass fibre bundle from a special light box and each strand provides an individual star light in the black drape or curtain to which it is attached.

MAC 500 Moving head projector

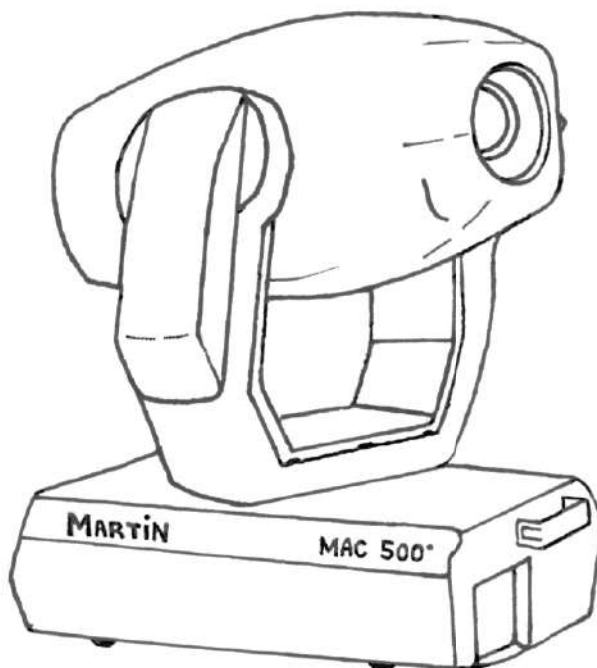

One of the most popular and useful lanterns for light entertainment, it may be flown overhead or floor mounted, with its unique properties such as;- Bright 575 Watt MSD bulb, fixed and rotating Gobos, 2 colour wheels, motorised iris, Prism, and remote focus.

17 degree beam angle, 440 degrees panning, 306 degrees tilting. The units are supplied in pairs from "Martin Professional"

Lasers

Lasers are in a class of there own, never allow cameras to look at lasers as fatal damage to the CCD pickup devices may occur and may cause permanent damage to

people's eyes. Lasers may only be used under licence and permission of the local councils or governments. Various classifications are given to different types of lasers, treat them as a special area of investigation; get the correct facts before hire.

LED's

Light Emitting Diodes, a new range of white light sources for low voltage applications which are very energy efficient and are now widely available from sources such as "Luxeon", they are provided as singles or in a ring of six LEDs in series for operation on 12 volts at 0.7 amps DC, or a 12 Led ring 140 mm diameter for 24 volts at 0.7 amps DC, they cost about £200 plus to make LED camera bashers a reality at low light levels. At present the colour temperature of the white light source is 8000K but future possibilities may provide a closer match to daylight perhaps by mixing other colour LED's. Inside vehicle illumination could also be made much easier with these devices. They are current fed in series with a small value resistor from a suitable voltage supply, a single high brightness narrow angle Led will provide one ft.c at 1 metre. Six will provide 6 ft.c at 1 metre, this is enough light to illuminate a face using a CCD colour camera. The more focused versions with a narrow angle will provide 5 ft.c at 1 metre; therefore six should be able to achieve 20 ft.c at one metre. I fully expect to see these introduced for Electronic News-gathering crews now or in the very near future. A hand torch is already available with a very bright beam and provides enough light for my CCD colour camera to produce acceptable pictures, the colour balance looks good at 8000K but night backgrounds look very red by comparison to the source key-light. Replacements for 35-40 watt halogen bashers are now available as white LED clusters mounted in a ring formation around the lens or as a separate camera basher, one advantage over halogen bulbs they may be dimmed without colour change, obviously they are very rugged compared to filament bulbs and have a very long life span of 30,000 hrs or more, 10 watts of LED light = 40 watts of halogen light. New to the range of LED encapsulations are the GU-10 Diotronic LED lamps containing 15 white LEDs sealed inside the standard GU-10 package rated at 1.5 watts at 240volts AC. Intended for domestic use in GU-10 type lighting fittings, 5 different colour versions are now available. The future looks very bright indeed as very high power versions are now available producing hundred of FTC at distances up to 10 metres or more.

Studio Cyclorama lighting

The drawing, Fig 10, is a cross section of a studio lighting grid, floor, and cyclorama made from special white cotton in the form of a continuous curtain. In front of the cyclorama curtain is a very fine net muslin or Sharks tooth gauze diffuser spaced about 40 cm in front of the cyclorama cloth, this gives the effect of depth to the cyclorama cloth and helps to diffuse the mixture of light from the Four-lights used to illuminate the cyclorama. As previously mentioned the Four-lights may be fitted with colour gels, the luminaries are hung on telescopes from the lighting grid and may be placed in any position. The mirrors inside the Four-lights are ear shape and the bulbs horizontal as shown in the detail of the drawings. This provides an even amount of light from the top to the bottom and from the bottom to the top.

The curved section on the studio floor is called a Cove, this hides the lights on the floor from the cameras view and when lighted it merges into the painted floor.

In this drawing of the studio cross section, Fig 11, the luminaries shown are an alternative way of lighting a cyclorama using Sky-pans at the top and ground-row lighting units at floor level. This method of lighting the cyclorama is rather out of date

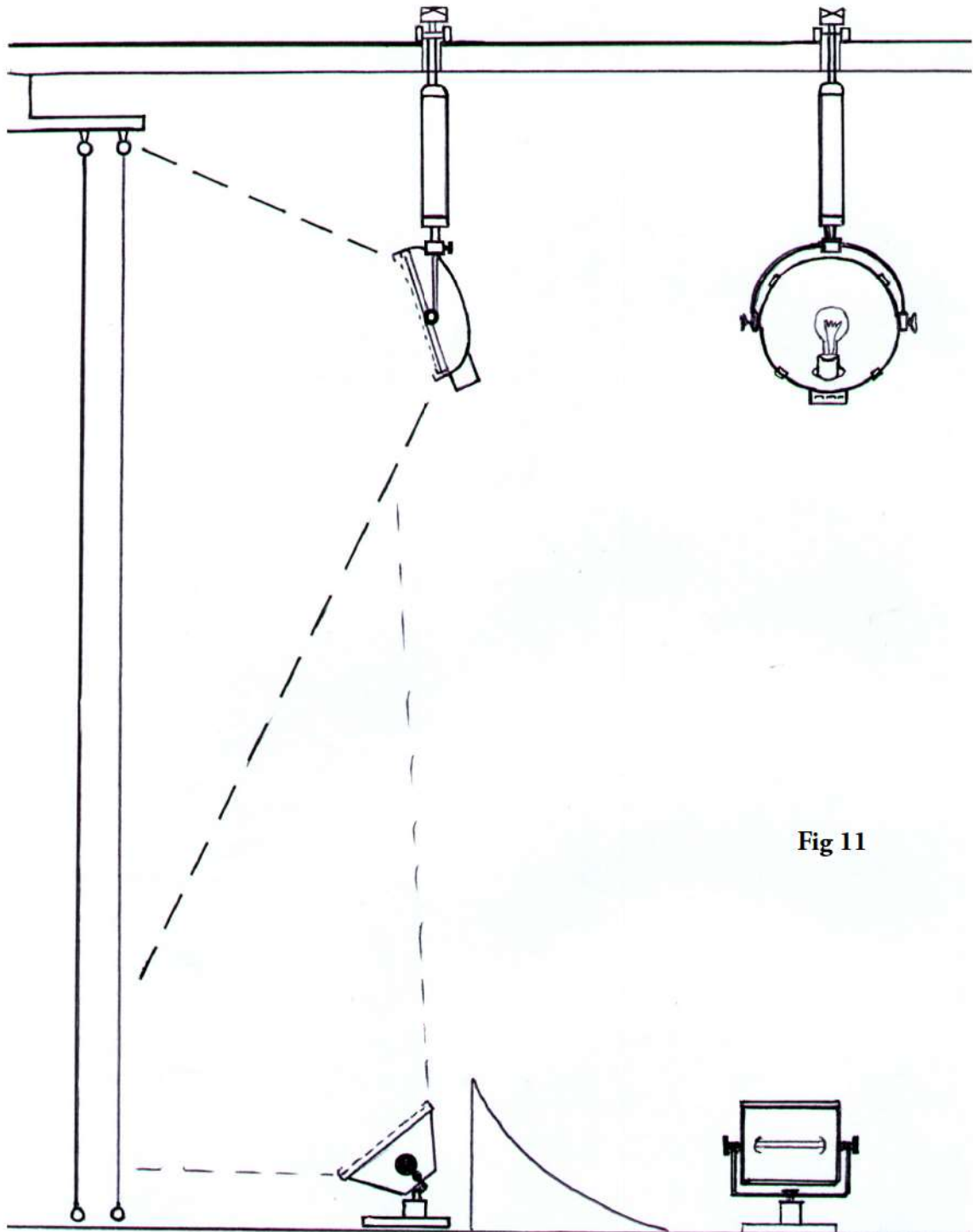

Fig 11

Ground row or top row lighting of backcloth or cyclorama

Special long boxes containing four compartments with 1000-watt or 1500 watt QH horizontal filament bulbs with a “special curved mirror,” they come with filter frames to take as example red, green, blue colour filters fitted to three sections with one section remaining as white light. The gels are made from heatproof materials; the sections are connected to four individual dimmer circuits to provide full colour control of the back cloth. These units are normally close spaced end to end along the top and bottom of the back cloth or cyclorama.

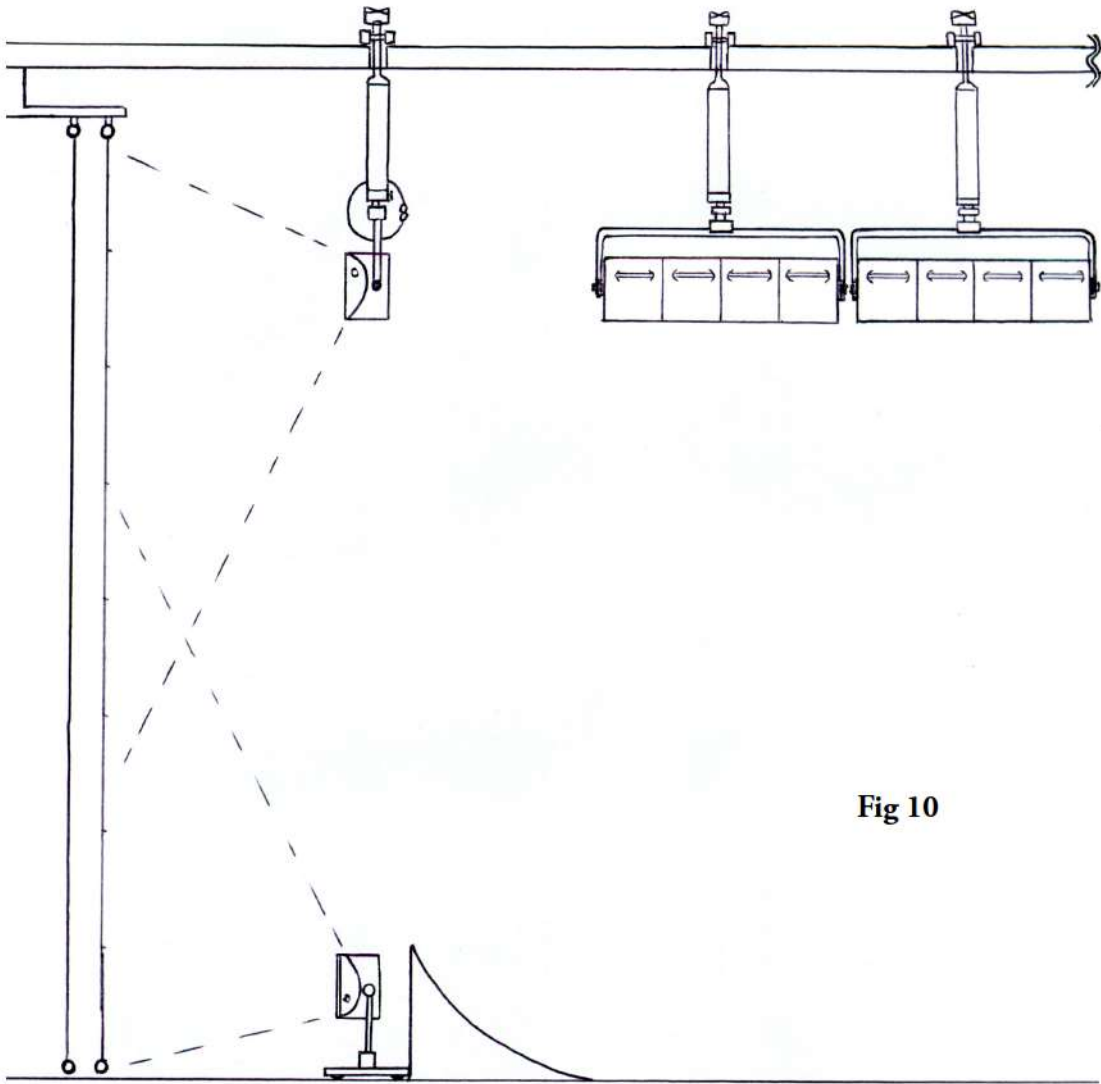

Fig 10



Special raised opaque cove

Used for lighting special objects such as diamond rings, gold, silver, watches, glassware, jewels, kitchen items tools and any specula objects. A specially constructed table in the form of a cove made from a sheet of opaque Perspex formed into a right angle in a very gentle curve so as to provide a flat surface about 2 metres wide with a depth of about 1 metre before the curve slopes to an upright vertical background. The Perspex is fitted to a shaped trestle consisting of two sides only joined top rear and floor front and rear, also joined across the front edge of the Perspex. This is made especially so that soft light may be placed at the rear and underneath the opaque Perspex tabletop and cove. It should present a completely white (3200 degrees K) and completely evenly lighted surface onto which is placed the objects mentioned above. If colour is introduced this is an open door for problems great skill and patience is required. This kind of lighting requires time to satisfy the client.

Some white sheets of linen cloth is arranged on a freestanding wooden frame to form a vertical three sided tent including the top, the whole thing is set around the cove so as to completely enclose it. Luminaires placed on stands and on the studio floor to evenly light all four surfaces. A hole is made for the camera to see into the tent, at a level to view the object. As the lighting is completely diffused there should not be any specula's visible. This method of lighting is used a great deal in advertising for stills, and television. In extreme close-ups the camera lens may be seen as a reflection.

It has been known, for the picture of a gold watch to take a whole day's shoot to satisfy the advertiser.



Photo 16

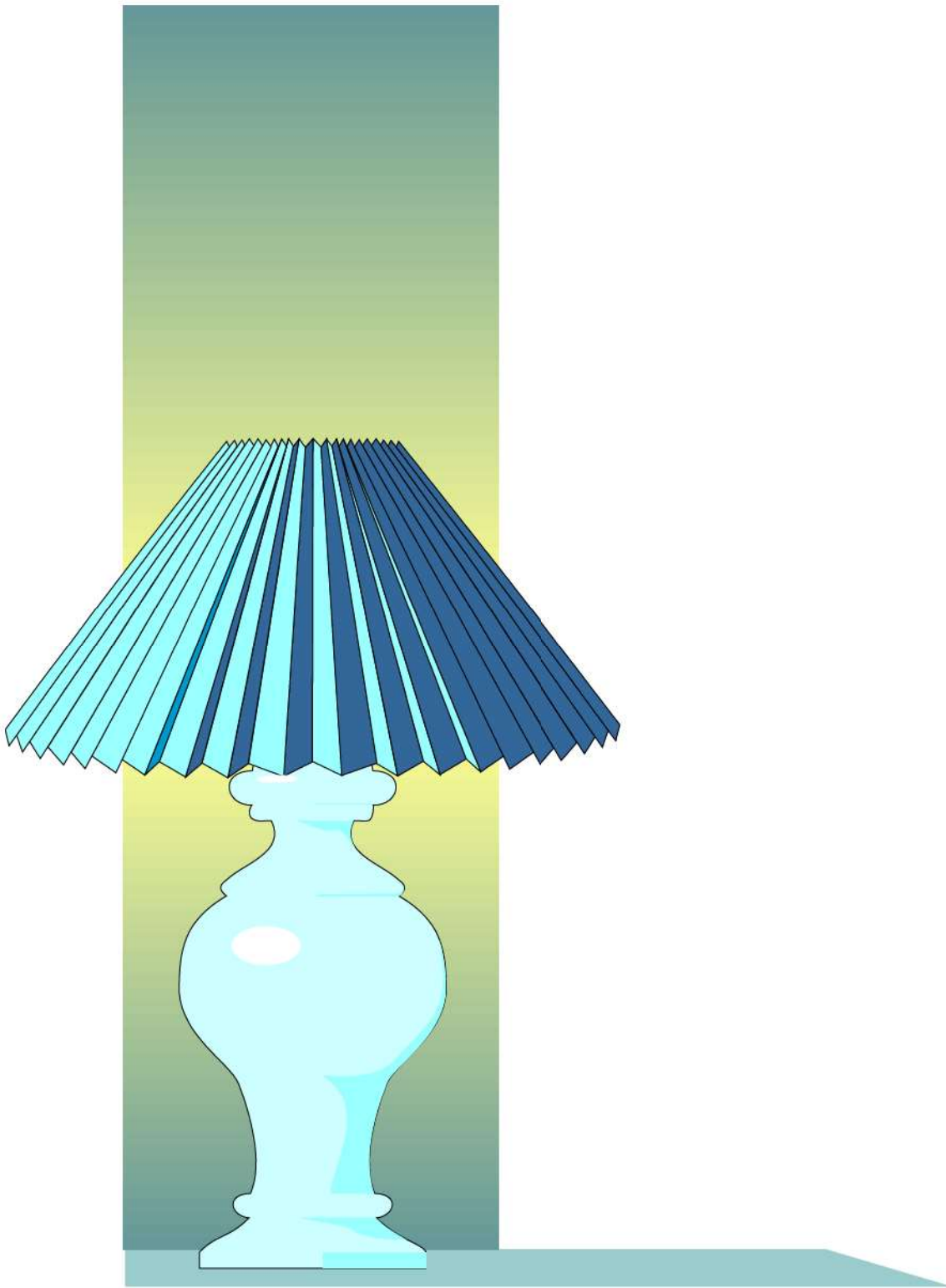

Typical lighting plots

The plot shown in Fig 12 was used on many occasions at The Royal Albert Hall London England.

The luminaries are suspended from the roof by trapeze wires attached to a short barrel, setting the focus and the barn-doors is carried out from a Tall extending self supporting ladder from 5 and up to 15 metres maximum height. The four outside corner ring lights are set at full flood with barn doors trimmed to confine the light to the play area, they are set at an angle of about 40 degrees in order not to throw a shadow of the suspended nest lights in the centre of the ring onto the opposite corner, the height of these four luminaries is judged to be around 12 metres at a distance of 8 or 9 metres from the corner post, with bottom half wire scrims in all four luminaries. The lighting level is maintained at quite a high level

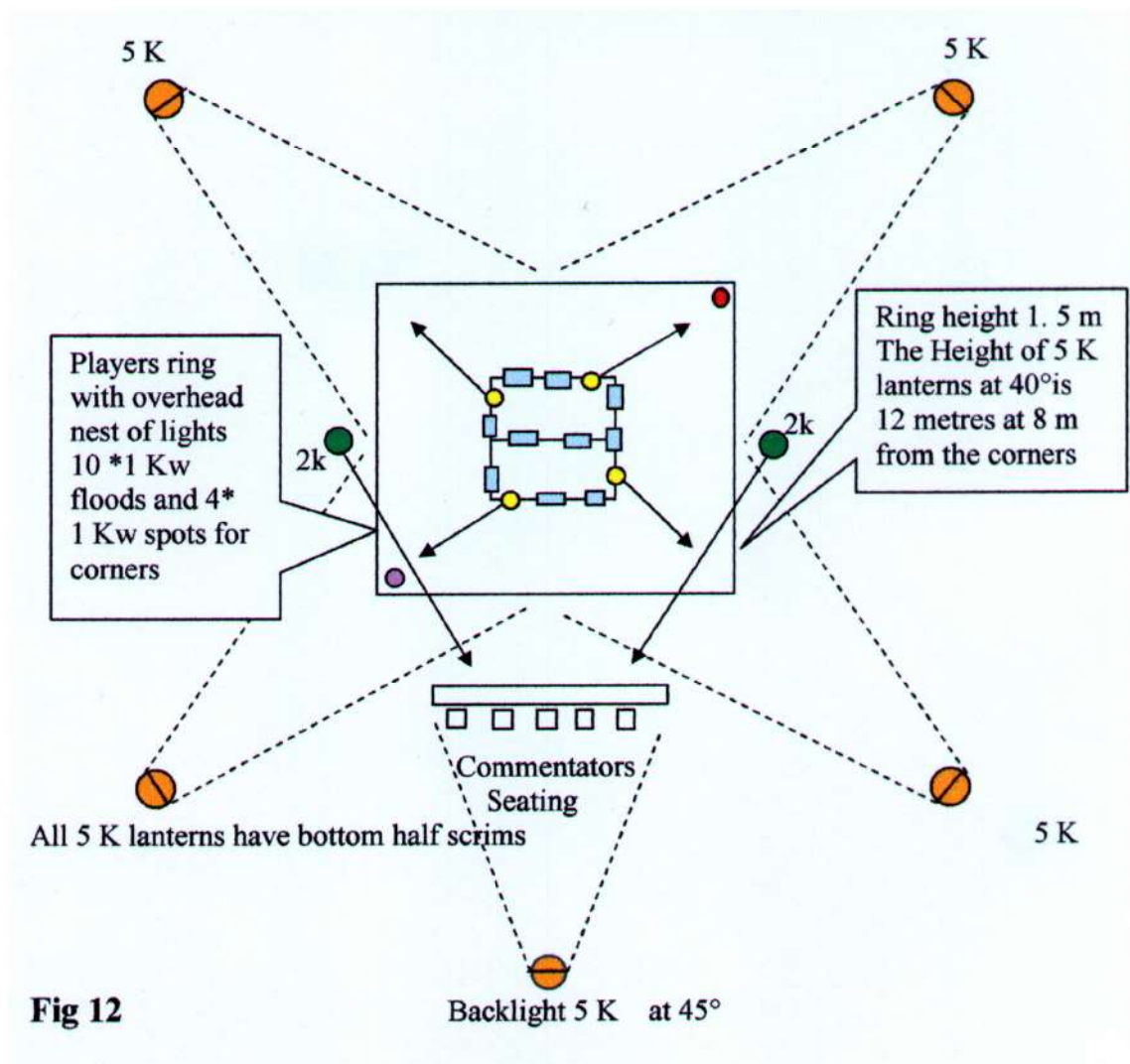

between 150 to 200 ft.c incidents, this is because the cameras are often placed far from the ring and rely on zoom lens operating at a practical focal length and F-stop.

Lighting plot for boxing or wrestling ring

This arrangement of lanterns should satisfy all camera positions.

The lighting levels at each corner must be at least 150 ft.c incident allowing for the use of zoom lenses on all cameras, the overhead lighting nest must provide the same amount of light measured at head height above the canvas and evenly distributed with no hot spot areas.

The lanterns coloured yellow are 1 K Fresnel spots focused to give the same incident level in the corners. The height of the nest lights must be more than 4 metres from the canvas; my preference is at least 5 metres. It is possible with this rig to increase the incident light level to 200 ft.c by adjustment of the lanterns focus controls.

For the entrance and exit of the contestants a couple of follow spots will be required the positions being dependent on the local arrangements, the dressing rooms and walk ways may also need to be lit for any handheld cameras.

The nest lights above the centre of the ring may contain lights supplied by the boxing association, this has to be negotiated as four essential key lights are required to light the corners from the inside ring view, and some of the QH lamps provided may need to be switched off or supplemented with more luminaries. A 5 K spot is normally required at some position outside the ring to backlight the commentators, they are usually near enough to the ringside to be illuminated by the spill from the ring lighting but this plot allows for two 2K Fresnel spots as key lighting.

For an international event at least two hand held cameras would be used for the promotional hype and dressing room interviews, these would all need to be pre-lit.



All the cables must go up to the roof for their connections to the control room dimmers and switches, close co-operation with the house staff electricians is essential at this location.

Of course events at different locations will require a different approach these examples are only for guidance and understanding of what is involved. In the Boxing ring off air photo please note the rear pair of 5K corner key-lights and the overhead nest box of floods at 5 to 6 metres in height above the ring similar to the plot fig 12.

A five person discussion format for a television show

Fig13 Shows a semi circle scene set with a semi circle desk, the centre position on the desk would be for the host and to the left and right the guests are seated.

With this type of scene setting there would be an audience seating area to over view the set. Four cameras on gas filled pedestals able to move anywhere around the front of the set and also able to take reverse shots of the lighted audience.

For simplicity I have not included the audience lighting, the set is a perfect half circle 3.3 metres high with colour painted panels showing slogans appertaining to the show, with High frequency neon's spelling out the name of the show repeated six times. These panels are illuminated with frontal dressing Fresnel lanterns 1 to 6 fitted with top half wire scrims and barn doors, the light from these lanterns must not spill onto the seated people so they are hung from the lighting grid at a height of five metres.

The desk would be fitted with high frequency neon's to avoid interference to the audio system and would appear in various colours to decorate the out-line, desk microphones would be fitted for each seated person.

Backlights 12 to 16 are Fresnel lanterns fitted with barn doors confining the light to each individual person. These lanterns are placed at a height of four metres clearing the top of the set and placed behind it to avoid any shadows falling down the face of the set from the dressing lanterns 1 to 6.

Individual key lights 7 to 11 are set to a height of four and a half metres, with an angle to the horizontal of 30 degrees.

Fill light from four North lights fitted with diffuser frames individually adjusted to provide a comfortable level of fill light on the faces, lanterns 18 and 19 switched to 2K watts, and 17 and 20 switched to 1K watts, adjusted to a clearance height of three and a half metres from underneath the lantern housing.

As all five people will be looking at each other and the audience the three nose objects drawn on the plot are meant to show the directions that each person could be looking and I have used this method for plotting the direction that any artiste adopts in rehearsals for all kinds of productions. If it is drawn on the plot in the final dress rehearsal it provides a guide to placing lanterns on the lighting plot for the final production.

To run this show from start to finish a sequence of events will take place in this order: Make sure the studio house lights are switched off.

When the studio floor production rehearsal is in progress and the lighting is completed to your satisfaction your consol operator will have set up the groups of lights as you have requested.

The neon's are practical lights, which have a major impact along with the set design and will be directly switched circuits. Before the start of the show and before the audience is allowed in to there seats the neon's must be switched on, Backlights 12 to 16 also switched on. The audience lighting should now be on and the audience is allowed into the studio, a warm up funny man is in the spotlight to get the audience comfortable and ready for the show, this also gives a leisurely start for the introduction to the host and the guests who now take their seats within the set. The production starts the countdown for transmission and recording, on a cue the lights 17 to 20, and 7 to 11 fade up on the host and guests, Cam 2 takes the first shot a mid shot of the host presenter who introduces the show and the guests, Cam 1 and Cam 3 cover the guests in wide three shots relating the presenter with them left and right. Cameras 4 and 5 which are were in position to provide opening captions and names now join the main set and by the use of a carefully worked out camera sequence Cam 2 moves alongside Cam 1, Cam 5 replaces the centre cam position by swinging around 180 degrees and Cam 4 moves to the right alongside Cam 3.

The production Director may now see the faces of all five persons on five separate camera shots, as the show progresses the audience lighting may be required for reaction shots and your consol operator will need to be cued to raise and lower the audience lighting as required by production control. Alternately the audience may have permanent subdued coloured lighting

Towards the one minuet countdown to the end of the show your consol operator will be waiting for the cue to dim out all key and fill lights leaving only the set dressing lights 1 to 6 and the backlights 12 to 16 on, and also the neon practical lights.

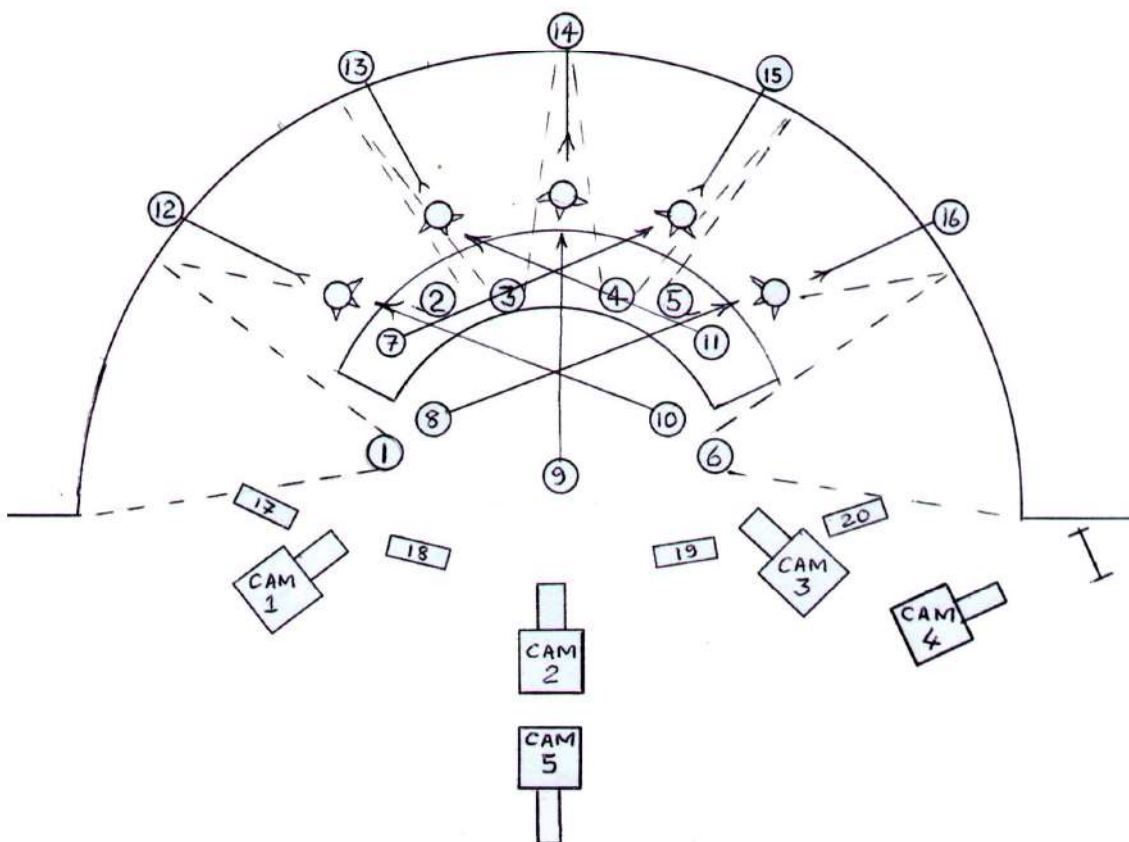

Fig 13 Lighting Plot for the five people in a discussion program suitable for television only.

Captions will appear over the final wide angle shot from camera 5 and when the end caption appears on cue a picture fade to black will be the final action of the production control crew. You may now switch the studio house lights back on and switch off all the other studio lighting.

Lighting a grand piano in the television studio

Fig 14 The composite plot includes the pianist and solo singer, the singer would be the star performer accompanied by the pianist, or alternately the pianist would be the star.

In the studio plot shown camera 1 has a view of the right hand side of the keyboard with the ability to obtain CU (close up) of hands and keys, MCU (medium close up), MS (mid shot) of the pianist, keyboard and hands. All achieved by the use of the zoom lens.

Camera 1 has the ability to track in and out with the mobile pedestal, and also position left or right, in this way the composition of the various shots may be adjusted.

Camera 2 will be able to see a CU of the pianists face and is able to widen out to include the pianist at the piano including foreground and backgrounds, for the wide shots available.

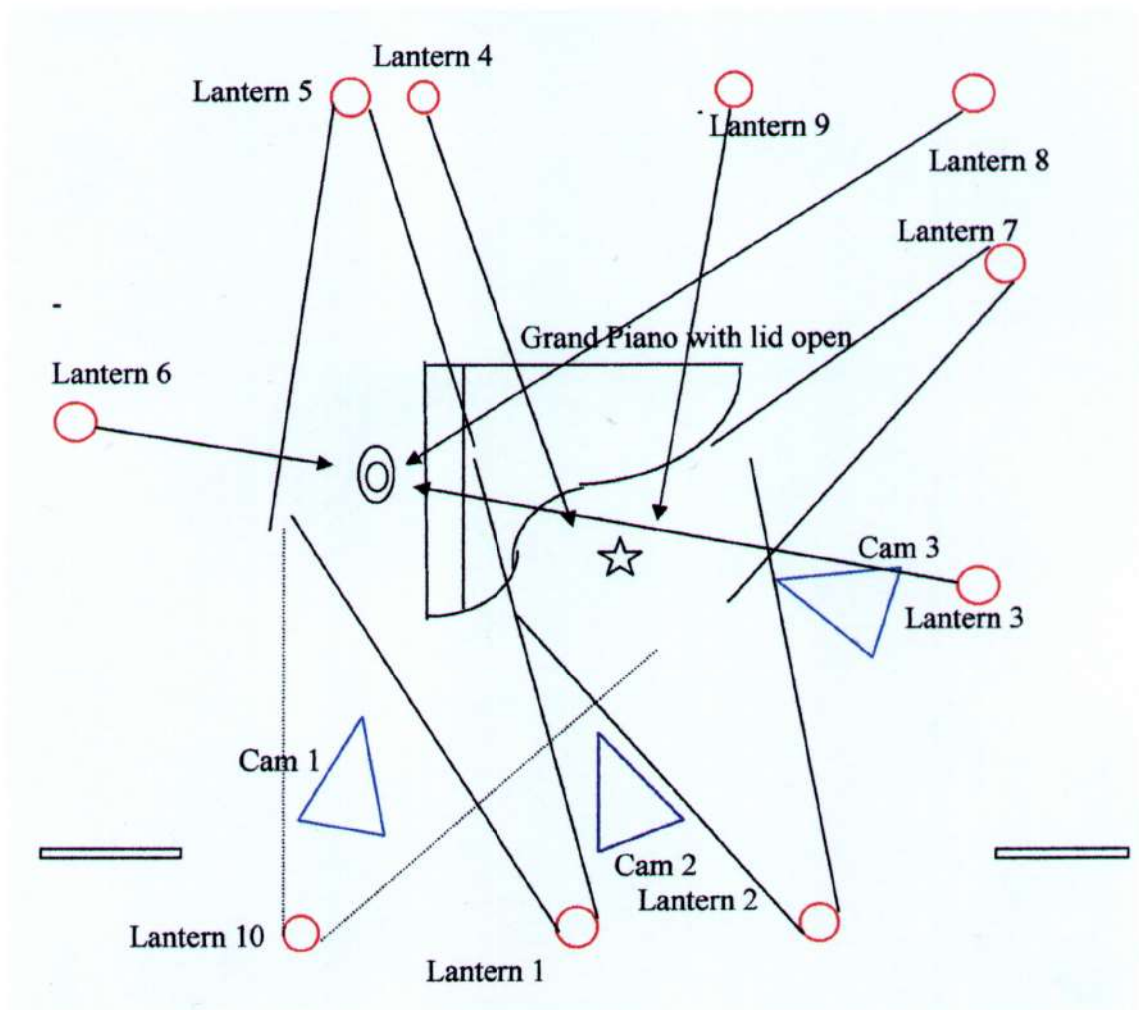

Fig 14 Lighting plot for, Grand Piano, the pianist, and a Star artiste,

Camera 3 may also get tight close ups (CU) of the pianist whilst the other cameras move to new positions, this camera may also get high enough to look down inside the piano for effects mixing shots and different wide angles of both piano and artistes

By careful plotting of camera angles every aspect of the scene may be covered in a continuous recording of the event. As this is a studio production for television the studio floor noise has to be kept to a minimum so as not to distract the artistes and an invited audience would be possible but not essential.

The lighting plot shows 10 luminaires or lanterns hung from the lighting grid, lantern 1 is the key light in combination with lantern 5 as a backlight and would satisfy camera's 1 & 2. Camera 3 would need lantern 8 or lantern 3 to dominate as a key light and lantern 6 as a backlight, if lantern 8 is used as the key light, lantern 1 would be the hard fill light or cross key.

Lantern 2 is used either to light the well of the piano or to key light the star artiste, lantern 10 would provide a cross key for the artiste. Lanterns 4 & 9 are used as backlights for a close-up of the artist or a wide shot on camera 2. From camera 1 viewpoint, lantern 10 is the key light and lantern 7 is the backlight. Camera 3 is able to see the star artiste in profile with the pianist in background.

The whole lighting situation discussed is a guide to lighting a grand piano in a studio situation and will in practice have many variations, please note there are no soft lights used as this would tend to wash out any foreground or background lighting which is related to the design of the setting.

Lighting a grand piano in the theatre

For theatre stage the piano may be rotated anti clock 10 or 20 degrees to help the audience to see the keyboard and right hand, the same basic plot rotated could be used on stage if one considers that lanterns 10, 1 and 2 are in proximity to the proscenium arch but equally could be follow spots from the balcony. The rest of the lights may be hung conveniently on the stage lighting "Pipes" (suspended lighting barrels) or from vertical stacks at stage left and stage right.

Fixed Camera positions within the theatre would most likely occupy the dress circle and some of the boxes at either side. On stage is more suited to hand held cameras on tripods in fixed positions as any tracking shots on a pedestal would be very poor unless a special floor was provided. The audience would not like to see evidence of cameras on stage any way and they should be hidden behind the bleaches (side masking wings or flats).

The type of grand piano is of some importance is it black or white? If it is black you may rely on reflections for special camera angles, if it is white, lighting can be quite a problem controlling the hi-lights. All pianos come highly polished. And anti glare spray is required to cope with the high light flares.

It is worth noting that Jazz pianists are very unconventional and permit virtually any camera shot from any direction. Concert pianists do not like cameras looking at the left hand from that side, nor do they like key lights in there eyes, so cross keying is often the only acceptable way to light them. It is very important that the music rack is well lit if sheet music is being used.

In an orchestra setting three-point lighting is often used, lanterns 5, 10, and lantern 3 all on full flood focus with barn doors trimmed into the playing area. The piano lid should either be removed or closed down to be able to key light over the top of it

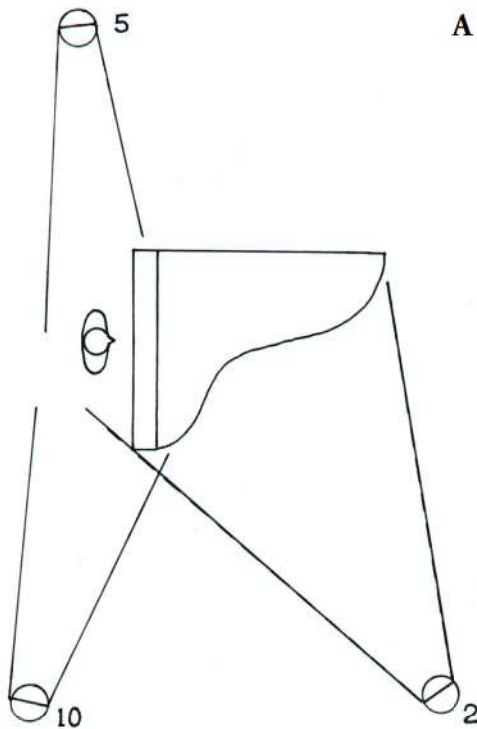

A The Basic three Camera positions are Cam 1, Shot of the piano keys and right hand,

Cam 2 a wide shot of star artiste with piano and Pianist, Cam 3 a close up of Pianist.

Lighting plot "A" uses three point lighting as part of an orchestra set up the lanterns are numbered as in Fig 14. Lantern 5 is used to light the keyboard the pianist including his left hand side, a bottom half scrim is fitted and the light beam should be confined with the barn doors. Lantern 10 lights the keyboard and the pianists right hand side, lantern 10 may be fitted with a full scrim to soften the light Lantern 2 is the main key-light for the Pianist and piano, Lid or no lid on the piano but not as to cause a lid shadow on the pianist.

Lighting plot B is suitable for any studio or stage presentation of the pianist and his piano lantern 1 is used as the main key-light for the piano, lantern 8 may only be used as a key-light when there is no lid on the grand piano. Lantern 6 is a small kicker high angle top or overhead backlight to be used with caution. Lantern 5 is used the same as in "A".

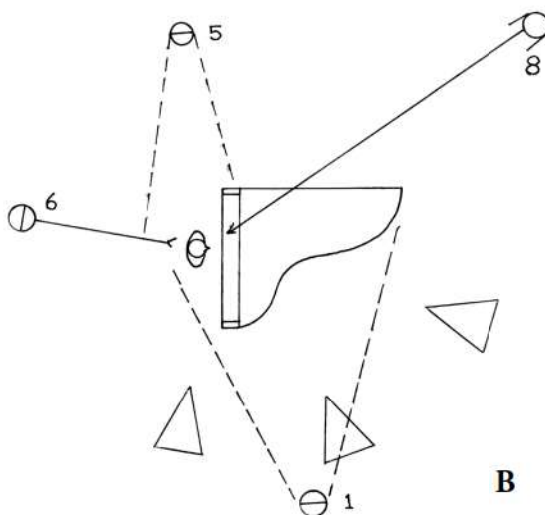

B

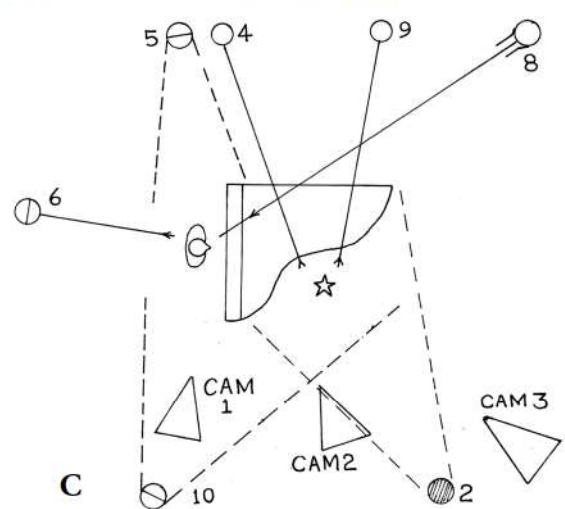

C

A more complete lighting plot for a guest artiste and the pianist

Lighting plot C, Lantern 10 with full scrim provides the fill light for the artist and pianist, lantern 2 becomes the main key-light for the star singer, lanterns 4 and 9 are the stars backlights, A follow spot could be used as the stars key light in place of lantern 2 and lantern 10 may be re directed to the pianist only. Camera 3 could be on stage right behind a flat

hidden from the audience view and provide the close-up shots, cameras 1 & 2 could be on the main balcony with long range zoom lenses. Lantern 4 & 9 artist backlights.

Lantern 8 may only be used as the pianists key light if the piano lid is removed.

Lantern 6 pianists top light, Lantern 5 used as left hand keyboard light. Note that the pianist is also key lit from lantern 2, lantern 10 lights the pianists right hand side, it is not possible to light him any other way if the lid is fitted to the piano at 45 degrees. Lantern 3 in Fig 14 could be used as the pianist key light but because of its position on the studio floor with an vertical angle of less than 30 degrees it might cause problems do include it in the rig even if it proves not to be used. Scrims to be used as required and all the plotted angles for lanterns are subject to individual choice as dictated by the studio or stage setting.

Cooking program

In the later days of my lighting career cooking programs became very popular and some of the formats I have seen on television have prompted me to include a cooking lighting plot and an explanation of the principles involved. The whole thing is a fiction but this setting is totally practical.

Fig 15 is the lighting plot and Fig 16 is the front elevation, the gas rings are centre stage with a continuous working top counter for presenting the ingredients and doing the cooking in front of the cameras, Behind and central is the two eye level ovens and microwave fan assisted cookers with work surfaces, shelves, and cupboards along the back wall of the kitchen setting.

Offstage there are duplicate ovens and microwaves used to pre-cook examples and a wash and clean station to provide a continuous supply of clean dishes, pots and pans.

To camera left on the set is a practical sink with running hot and cold water, and on the set camera right is a table and chairs to lay out the completed food for tasting by the Chef and any invited guests.

Essentially a presenter, Chef, and assistants work to produce the dishes of the day within a supposed 30-minute program time, but as it is an edited show it obviously takes longer. These programs are usually part of a series to be recorded within a working week for later transmission. Four to six programs a day for three or four days.

Once the lighting has been set up very little alterations would be required, an audience may be in attendance for each recording and may need to be lit for reaction shots but there is normally not much time for any such shots.

Five Studio floor cameras are recommended with two overhead cameras suspended about 4 metres above the central working area the studio should be well ventilated so that the lenses do not steam up. The overhead cameras must be carefully positioned to view into the pots and pans and will be remotely controlled. Some times a large mirror is suspended at 45 degrees above the working area but the camera scanning has to be reversed to get the shots orientated correctly.

The lighting for the this show assumes a “High Key” lighting set up and the persons have complete freedom within the setting to adopt any position for cameras.

As we have no place for a proper key light at any position the whole setting is illuminated

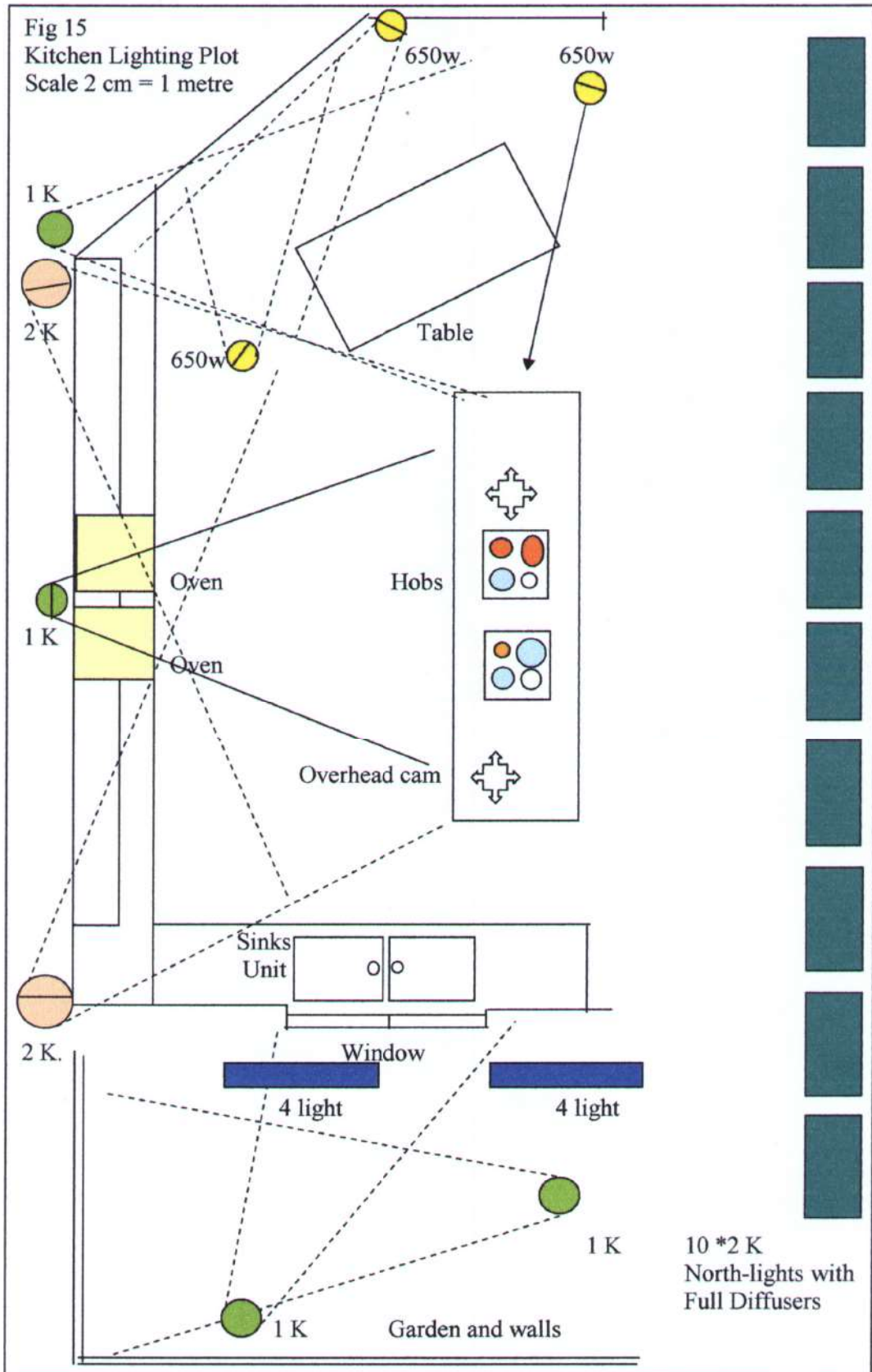

with a line of soft and shadow-less fill light. Dressing lights at various places and backlights will be needed to give depth to the setting. Some practical lights give authenticity to the setting.

The high key lighting allows for a continuous shoot without major lighting problems and provides boom operators with easy access to the various areas of the set, normally radio tie-clip microphones are used as this avoids the turning away from the boom microphone to face the opposite direction and momentary low sound level. When the cooking is near completion the show moves quite fast and so do the Chef's.

The 2 K rear cross backlights have diagonal scrims to maintain an evenly lit area between the ovens and the hobs, the central 1 K backlight is only for the people standing at the hobs, the garden wall is only seen through the window in a cross shot.

There should be practical lighting under the wall cupboards either side of the ovens to illuminate the work surfaces.

Practical lights would be fitted under the cupboards to the left and right of the two ovens centre, the garden to the left would have brickwork walls with shrubbery and flower baskets to be seen through the kitchen window when someone is washing vegetables at the sink. The table would be laid to camera right for the chef and guests to sample the results of the programs cooked examples.

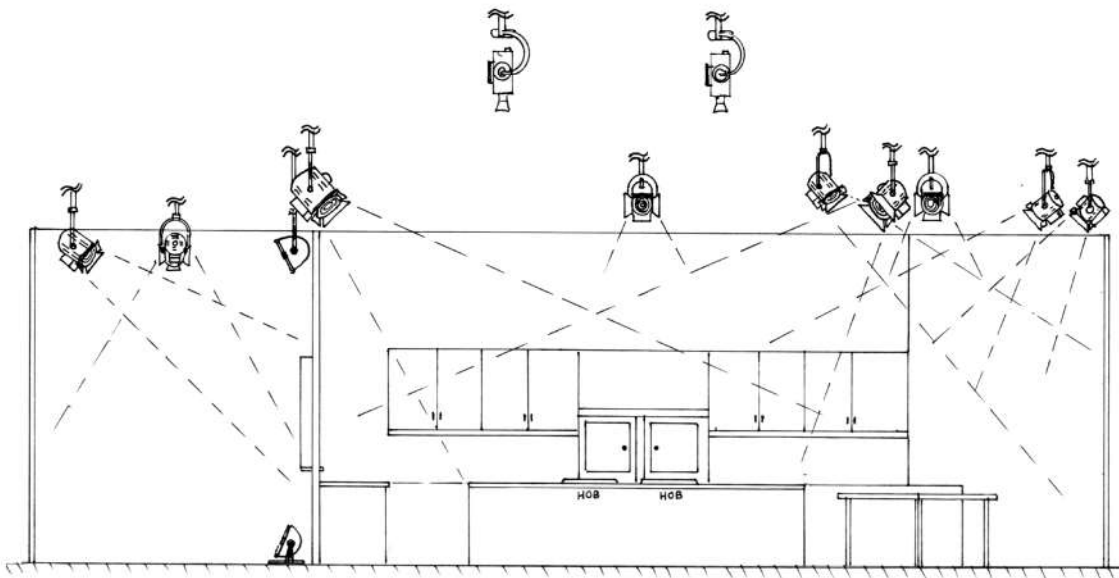
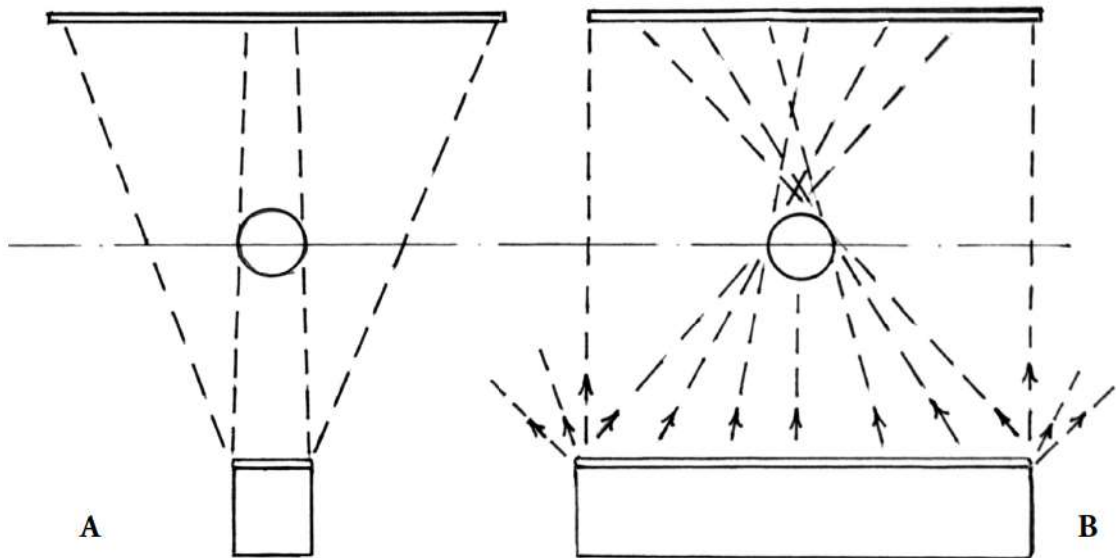

Fig 16 stage view of kitchen set as seen by the cameras and audience, showing the lanterns and two overhead cameras suspended from the lighting grid.

Soft and hard shadows

In the sketches shown on the next page, it should be abundantly clear a small source of light "A" will produce a hard shadow and a large area light source "B", a very soft shadow or non-existent shadow. Sunlight produces a hard shadow and a grey sky produces very soft shadows.



A typical small studio

Fig 17, The sort of studio you may find anywhere in a well-developed country around the world, the size is average 14 metres by 24 metres with a lighting grid height of 10 metres, and simple telescope or pantographs for lantern supports giving the maximum lantern clearance height of 7 metres. A pullback area for storage of lanterns and supports with associated electricians workshop for maintenance Fitted with a double Cyclorama curtain track at a height of 7 metres to provide a black drape on the inside track next to wall, and a pure white cyclorama cloth facing to the studio floor area.

The studio may have full control room services it will have a large scene dock door and separate entrance and exit doorways. A lighting control room fully fitted with television and lighting control system, I will assume in this case the three phase lighting supply is 400 amps per phase, and all lighting circuits are on dimmers.

That should provide 46 circuits for 2K's, 25 circuits for 5K's and 2 circuits for 10 Kilowatt's, plus a 5 Kilowatt supply for practical mains within the studio for non-technical use. House lights fluorescents or working lights use another 2 kilowatts.

The Television systems would be working from a separate AC supply called the technical mains and is effectively isolated from the lighting supply at the Power company sub station by the use of a U P S system (uninterrupted supply system). As lighting power supplies are considered to be industrial and dirty. If we use the studio to full lighting capacity of 250,000 Watts the ventilation system will need to consider the heating factor of say 50 persons as audience, 10 Studio crew, and about 125 Kilowatts of heat from the lamps!

The air conditioning must clearly maintain a working temperature that conforms to the law, and should never exceed 22 –25 centigrade. The air conditioning plant will normally occupy the total roof area of the Studio 14 by 24 metres and it needs to wash and refrigerate the incoming air. In winter it will need to heat the incoming air. The system expels the hot air and replaces the studio air at a low temperature to balance the conditions within the Studio at the set temperature.

It is by nature a low velocity system in order to keep the noise of the airflow to a minimum for sound recording.

The Studio must also be sound proof from ground vibrations Traffic noise, Aircraft noise and any industrial machinery located nearby. Normally the studio floor is isolated from the main building structure to avoid these problems, and the walls are covered with sound proofing materials. A good practical test is to place a hammer drill against the main building structure and see if you can hear it in the studio; from this test you will be able to judge the quality of construction of the Studio. The Studio should be acoustically dead, that means no echoes when you clap your hands.

The Television Studio floor should be flat and without bumps or undulations so that television cameras mounted on pedestals are able to track smoothly across the surface (Special floors are laid for this purpose) Most film studios have wooden floors and film cameras are used in fixed positions, or mounted on dollies supported by rails or tracks specially laid for each scene. Sound proofing of film studios is well below the standards of Television studios as live sound has not been a criteria, sound is only taken for guide tracks and much of the sound recording is done in the sound dubbing studios once the film has been cut or is in the process of editing. Film studios are often shed like in construction and aircraft noise is often much too high a level for live recording of final track sound. I have experienced this problem when working with live television productions in various film studios in the UK and Europe.



Emerson Lake and Palmer “Pictures at an Exhibition” A Crown International Production 27/04/1972 (picture from monitor).

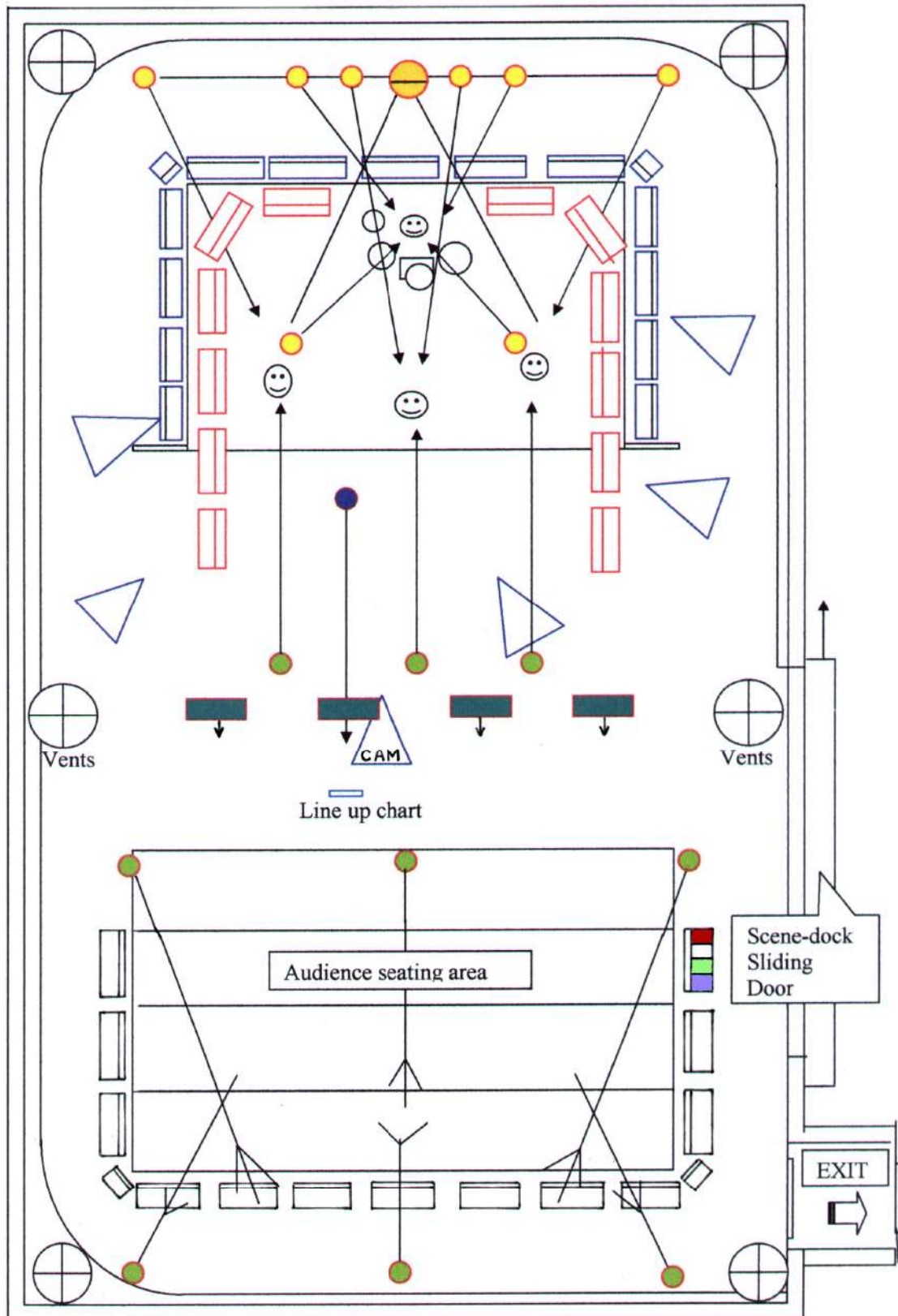

Fig 17 Studio lighting plot for POP group (Studio size 14 x 24 metres)

Pop group lighting in a small studio

Have a look at the floor plan fig 17 and the elevation drawing fig 18, this is a basic studio set-up for a small audience to appear in reaction cut-a-ways during the performance of the

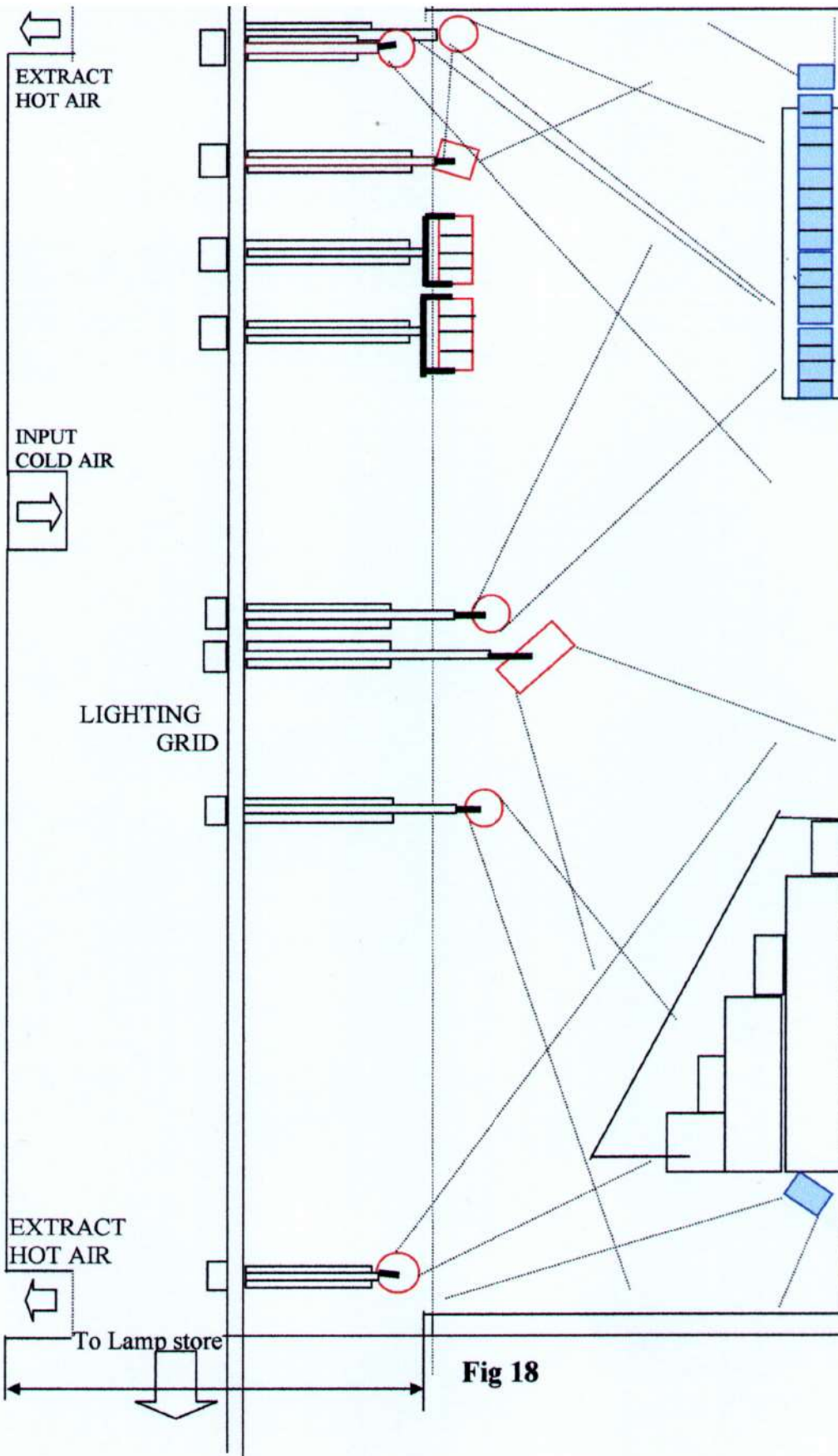

Fig 18

Fig 18 Elevation of POP studio showing the general arrangements of lighting grid above studio and positions of telescopes, lights and rostrums for the pop group and the audience seating arrangement

four-piece group consisting of lead singer with guitar, backing electronic Keyboard, Base guitar, and drums.

Note, all luminaries are on dimmers. The cyclorama is lit with four-lights White is 3000 K, and colours in the ground row are white, red, green, and blue. At the top of the cyclorama the four-lights have white, amber, yellow, and red gels, all Eight cyclorama lighting circuits are combined in groups of one colour each at top and bottom, All reds, all yellows, etc each group is on a sub master control circuit.

By blending the colours from each set of four lights many combinations of colours may be achieved on the cyclorama to suite the mood of the music.

The drummer is lit by cross backlights and cross key lights shadows are predominant but perfect in this situation. The other three persons in the group have individual straight in key-lights, and share three general backlights. The audience lighting is also on a prime control circuit, each luminaire is on a single dimmer but is combined to a sub master group dimmer control, and then to a master dimmer control, this is all done electronically within the lighting control consol.

What makes the show for the audience is to see their picture on the studio television monitors as part of the television recording or live transmission as most of the shots of them will be close ups, the cameras are able to move about the studio floor and obtain a great variety of shots of the show band from extreme close ups to wide shots.

Knebworth - A rock concert

Example

An up to date list of lighting and visual equipment to set up a large stage 100 feet across by 60 feet deep with a proscenium arch and gantry at 60 feet high and a stage floor height of 10 feet above ground level with a front of house pit height of 6 feet by 8 feet wide and 120 feet in length for a tracking camera on rails and several hand held cameras for close ups and crowd shots At either side of the stage are loudspeaker stacks to handle 10,000 watts RMS peak sound. The stage is entirely made from Scaffold and special lighting supporting structures with boarding and sheets of plywood to make even the working stage areas, with on stage rostrums and scenery including three giant digital television display screens as a background. The whole structure is covered and weather proof.

Hired in facilities such as the outside broadcast colour television system for 11 cameras with digital video tape machines one for each camera, complete with all the up to date electronic visual effects. Analogue sound mixing and digital recording and playback facilities. Plus the special video display control mobile unit with the local sound control recording and playback system for the pop group.

Three lighting towers at 30-40 feet high providing for cameras and follow spots at the top and audience lighting, the centre tower providing space under it at plus 20 feet providing a platform for lighting and sound control room, situated about 50 yards from centre stage. Access by ladders and controlled by security guards with immediate access to fire extinguishers.

The lighting rig and associated equipment is an example and may consist of the following list of equipment:

List of Lanterns

- 5 Pairs of MAC 500's front stage dressing foot lights (5Kw)
- 10 Pairs of MAC 500's upstage backlights for band (10Kw)
- 10 Pairs of Mac 500's from proscenium arch at 45 ft height facing band upstage (10Kw)
- 30 times 1kw Par lanterns arranged in pairs stage left (30Kw)
- 30 times 1kw Par lanterns arranged in pairs stage right (30Kw)
- 40 times 1kw Par lanterns arranged in pairs for audience (40Kw)
- Par lanterns use (Narrow, Medium, & wide bulbs)
- 40 times 1kw Par lanterns for stage dressing lights (40Kw)
- 40 times 1kw Par lanterns for colour stage Washes (40Kw)
- 8 Follow spots 5Kw each with long range lens (40Kw)
- Fog machines, Dry ice machines, Fireworks (10Kw)
- 240 volt AC supply's for all services. Load total=255 KW.
- With a total of 120-2KW Dimmers, and 10-5KW Dimmers, the max load is 290 KW.
- Silent generator to provide 300KW at 240 volts AC dedicated to lighting only.
- A separate 200KW Silent Generator to provide services such as, work-lights, Sound system, TV systems, Communications systems, and emergency lighting systems.
- Two lighting consoles, one DMX consol for MAC 500's for effects lighting, the main consol with chase and sound modulation special effects, digital memory and control of individual dimming of all circuits other than 10 KW-feeds. Lighting files are stored on floppy discs or CD ROMs.
- Talk-back systems for all operators of lighting equipment and a two-way personal radio system for all the associated crews and security personal plus Strategic national telephones.
- A large assortment of colour acetate heatproof gels and frames, spare lanterns with all types of spare bulbs, plus narrow, wide, and medium Par bulbs. Spare lighting power cables and dimmer units.

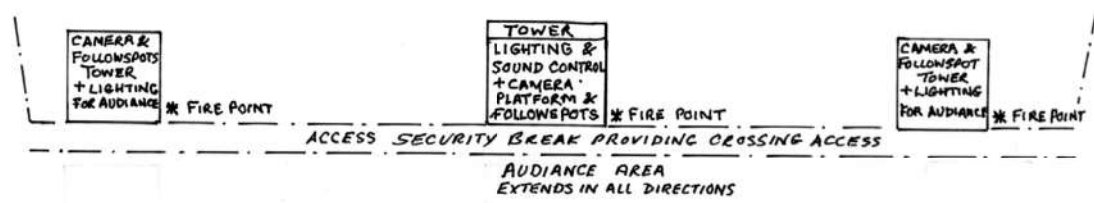
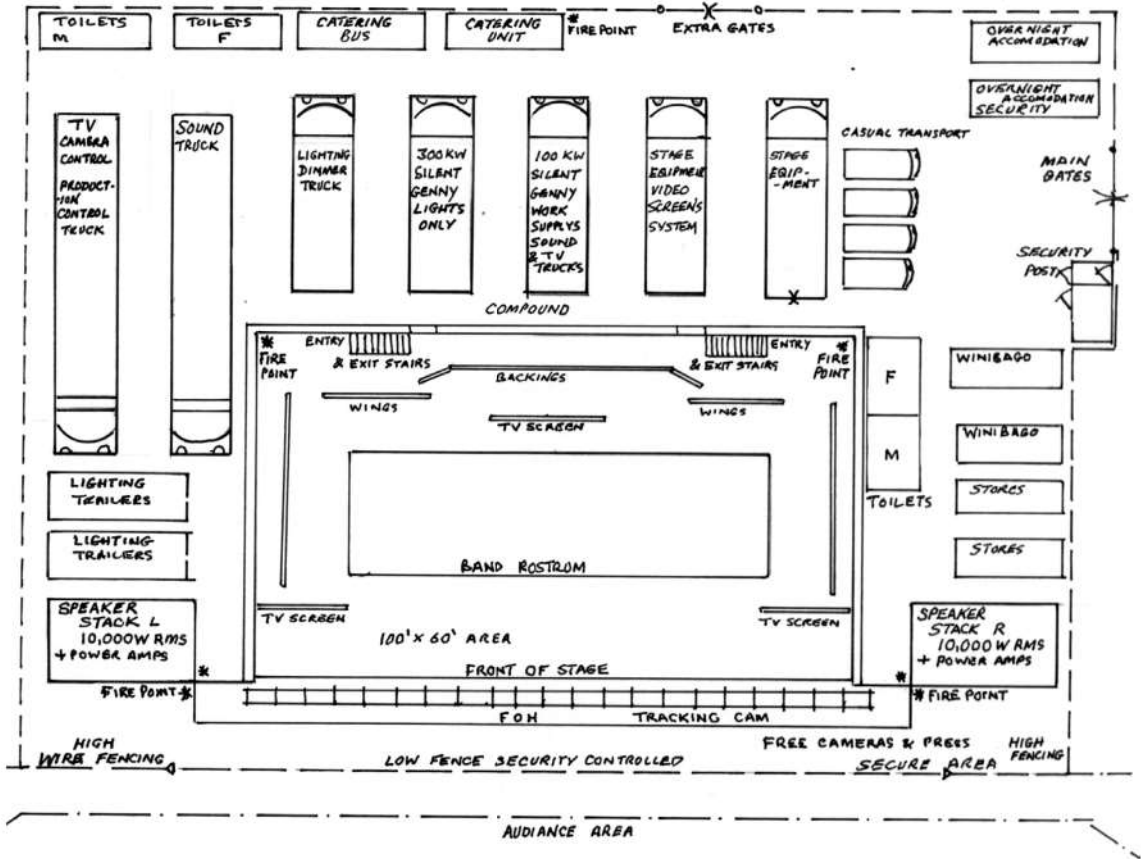

“Knebworth” an example plan view of the staging layout and facilities.



Drama lighting plot with script for kitchen sink drama

In order to explain the reasons behind the placement of our lanterns in the lounge set a script is necessary in order to provide an explanation of the rehearsal preceding the shoot. There are four characters: -

- John Conrad as the husband
- Lisa Conrad as the wife
- Tom Conrad as the son
- Vanessa as the daughter in law

Scene 1, a family enjoying the evening watching television

There are two Camera positions for this scene for coverage by two television cameras or two film cameras.

The opening shot is on Cam 2, it is a wide two shot establishing a cosy lounge setting with a warm glow flickering over the occupants from the open fire.

Tom and Vanessa sitting on a settee watching television (a practical television receiver with a program of light entertainment) the sound is to be heard on playback speakers positioned within the studio set, the volume level controlled by the sound supervisor. A boom microphone positioned just above camera picture frame and central to the wide two shot, some laughter comes from them both as they are watching.

The father John comes into the room from camera right

John speaking his lines, "Hallo you two, is it good?" He walks into shot from cam right and crosses the wide shot

Vanessa, "Yes it's very funny"

John, "Oh good I was hoping not to miss the show" John proceeds to the armchair and sits down, camera two pans left as he does this to see him sitting,

John, "Lisa has put the kettle on"

Cut to Cam 1 for MCU of Vanessa,

Vanessa- “Does she need any help”

Cut back to MCU on Cam 2 on John

John, “No I don’t think so” and John laughs at the show obviously enjoying it.

Now Cut to Cam 1, showing a CU of Tom with a grin on his face

Cut to a wide two shot on Cam 2 of Tom and Vanessa seated and on cue Lisa enters from cam right-and stands with her back to camera and places a tray of teas and biscuits onto the table in front of Tom and Vanessa

Lisa, “I have been listening in the kitchen and it sounds really funny” she picks up a cup and saucer from the tray and takes it over to John,

Lisa, “here is your tea John I have put one sugar in it for you”

Cam 2 pans with her as she does this, she pauses to look at the television, whilst John gets a hold of his tea cup and saucer, she then turns to walk out of the room,

Cut to MS of John on Cam 1 the camera stays on John for a moment as he is holding his tea and reacting to the television.

Cut to Cam 2, showing a wide shot as Lisa leaves the room, Lisa leaves to camera right following the dotted line on the lighting plot.

Cam 2 gently zooms in to Tom and Vanessa holding them in a two shot.

At this point we may continue or stop for an edit, for the explanation of the lighting plot we stop here.

From the script we now have a reason for the action within the lounge, the lighting plot shows the positions of the actors standing or seated or walking (dotted lines) the scene has been rehearsed right up to the final rehearsal so now we have some defined positions to light for the camera angles agreed by the production director and cameraperson. Following the basic rules of three point lighting with a Key light, backlight, and a fill light, you may judge my positioning of these luminaries as shown on the lighting plot.

For the two film cameras I have chosen to use 200 ASA daylight (5500 K) colour negative stock with an aperture of F 4. 5 on a fast 10:1 zoom lens, the cameras are fitted with “Tokina” 80B blue colour correction filters converting from 3400 K to 5500 K. and for correct exposure the incident light level of 125 ft.c. The practical wall lights are fitted with 60 watt candle opaque bulbs and small plain white shades, the standard lamp is fitted with a 150 watt tungsten opaque bayonet domestic bulb and the shade is semi transparent most of the light falling on the ceiling and floor, the light from this lamp is about 2800 K as are the practical wall lights.

Four dressing lanterns D1 to D4 are 650 watt MR Fresnel spots (marked yellow on the plot) are provided to illuminate the curtains of the window areas and the bookcase camera right and the display cabinet cam left of the setting. These lanterns are at full flood and are fitted with various wire scrims to even out the light as artistically required.

For the backlight on the sofa a 1 Kilowatt Fresnel spot is chosen to provide about 60 ft.c of backlight and is fitted with a bottom half wire scrim, and its direction is from the practical

wall light, the barn-doors are trimmed to remove any flares into both cameras positions. The single armchairs both have backlights which come from the positions of the practical wall light and the standard lamp the barn-doors are confined to a seated position in each armchair these two back-lights are fitted with full wire scrims and the light level set about 60 ft.c, the key light is adjusted with the focus control to provide 100 ft.c incident light level on the seated position and the barn doors are set allow for a standing position immediately in front of the armchair, with a bottom half wire scrim fitted to the lantern.

The standing positions in the middle of the room are cross keyed from left and right rear with 1 Kilowatt Fresnel spots, the left hand cross key must not backlight the armchair in the seated position but may do so in the standing position in front of the armchair, a three quarter side scrim is fitted to the left side of the lantern to even the light level across the room. The incident light level is set slightly higher at 125 ft.c for both cross keys, the right hand cross key has a diagonal wire scrim on its left hand side of the fresnel lens.

The way out of the room is lit by the 650-watt Fresnel spot on full flood from the extreme right of the setting and assimilates the light from the nearest practical lamp.

The television set on its own, will provide enough light to show variant illumination.

As the highlight brightness will be on average about 80 ft.c, and if this is not enough turn the brightness control towards the maximum, as we do not see the picture in shot, all we need is the effect. The light it gives will appear blue because the white screen is about 5000 K. As we have very little fill light on our setting we rely upon this to give some atmosphere to the room, plus a practical fireplace assimilated by a flag of rags hanging in front of lantern fitted with a warm pale red selected gel that looks to the eye like a flame from a real fire and a low velocity fan to action the movement of the rags to get a flicker effect. Some times a props special effects fire run from a gas bottle may provide quite enough light; some times both are used to get the effect.

The 2 Kilowatt North lights used as fill lights are switched to 1 kilowatt and may be adjusted by dimming and fitting diffusers to obtain a balance of light required for artistic reasons rather than actual light levels as this is a matter of individual choice.

The outside scenic backdrops are created from real photographs by projecting the photos onto the backing flats in the scenic workshops and drawing over the projected picture and finely painting the scene. These flats are then erected in the studio at a suitable distance from the setting windows (at a minimum distance of 2 metres for lighting) these flats may be fully lit for any part of the day and colour gels will be required to make the backing flats look authentic for night or day, in our setting a winters evening with cold blue light and not very brightly lit, the level set between 30 ft.c and 50 ft.c as judged by eye or on a Polaroid snapshot or by use of the colour television camera assist system. The ground row lights may be at different light levels to the overhead lights and may have different colour gels fitted to provide a graduated change of the colour from top to bottom.

In the lounge there are two windows and a pair of French doors centre rear, on the plot is marked the true north and this may be indicated by the designer for use with other scenes and would be used to provide direction of sunlight through the windows at different times of day, morning sun would come through the left hand window and mid day through the right hand window, and at sun set through the French doors and right hand window.

This provides the lighting person reasons to place the lighting lanterns in positions to obtain a directional quality to the various scenes. Light should not come from two opposite directions

unless there is a valid reason. By changing the colour of the opposite source this may validate the different directions.

The live sound pick up from the artistes is done entirely on a boom microphone and placed as shown on the plot, the boom operator must have a clearance head height of 4 metres minimum under any lanterns and the boom must work above the light beams to avoid shadows if there are any boom shadows they should be well out of shot. The lighting person must give consideration for the live sound pick up and co-operate with the operators in order for them to get the best sound. The camera positions are shown for simplicity but in a real situation would be positioned to get the best picture composition possible.

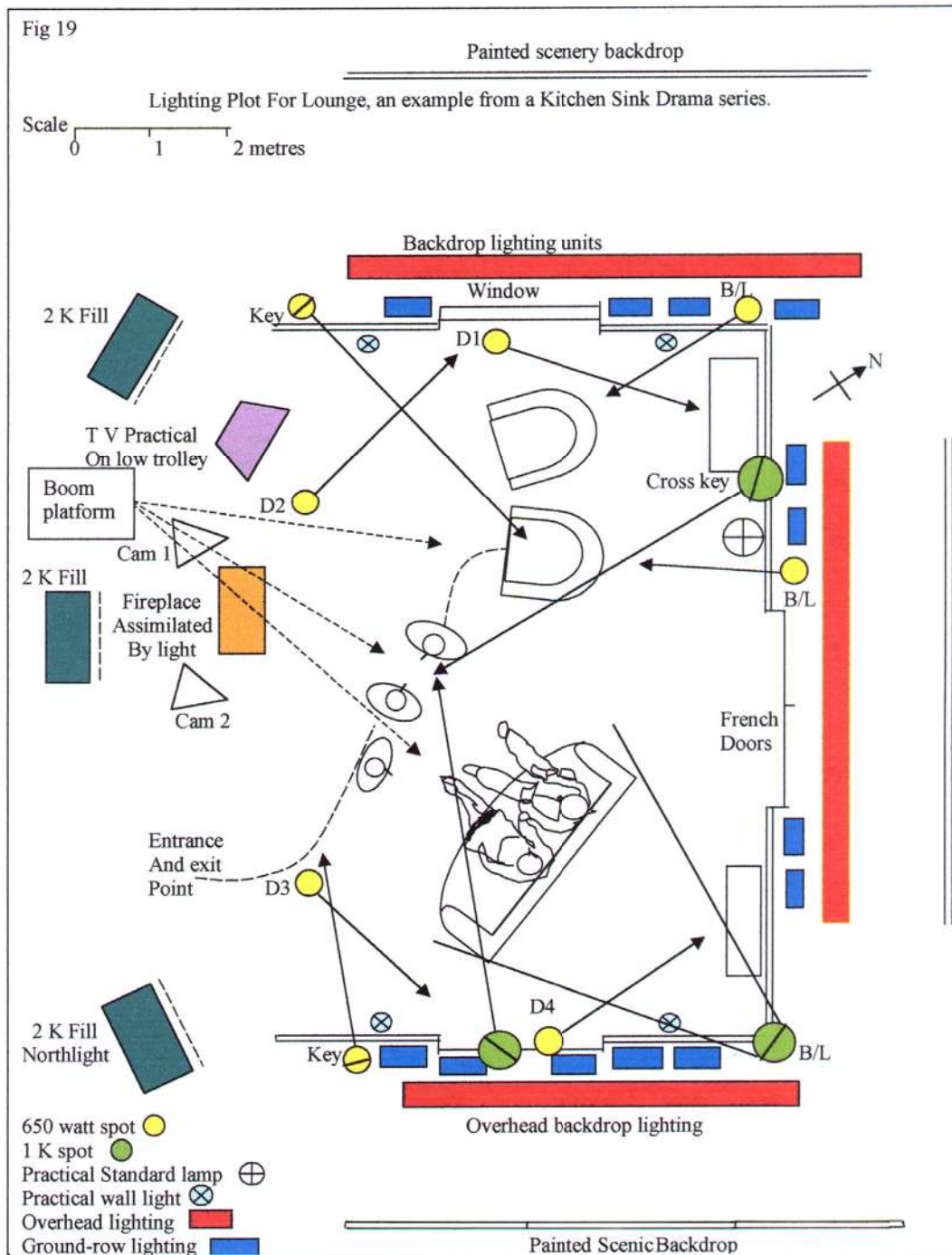

Lighting plot fig 19 is based on a real location and the photos of it.

The mood of lighting I have tried to create is reality with the time of day as a winters evening with a warm friendly glow from the fireplace. The people settling to enjoy a comedy television show sharing their laughter. The lighting set up favours continuous television direction but is just as valid for filming in a non-continuous way.

In this example the lighting levels are as valid for filming as they are for television cameras.



Photo 90

The location photos 90, 91, 92 taken during the day are used as examples for the drama setting in the studio scenes both for the designer and the lighting crew. If this were to be used as the real location for filming or televising the windows would be covered with CT Orange gels to convert the blue light from outside to match the quartz halogen lighting inside at 3200 Kelvin. The other choice is to use daylight colour HMI lanterns inside for the lighting, in order to match the day-light outside coming through the windows.



Photo 91

If a window is too bright due to sunlight coming through, it would be covered with neutral density filter gels of a suitable grade to balance the light levels inside.



Photo 92



Photo 93

Location photos at night time 93, 94, 95 using tungsten light at 2300 K which allows the practical lights to be used effectively.



Photo 94



Photo 95

The close relationship of the lighting person to that of the director

From the first concept of the script to the actual reading of it the director of the proposed production will require his or her lighting person to read the script and to form ideas of the scenes and how they may look, are the directors concepts similar to that of the lighting person and how much experience does he have in motion pictures. The directors choice is fundamental to his views, having seen some of the previous work of the person he has chosen, how much experience has the director anyway? What if? It is his first film or production, getting together is the first step, views and opinions must never be in conflict as this would be a recipe for disaster. Working together on the script is essential before agreeing to the scene-by-scene details and concepts. An experienced Lighting person will know how to interoperate

the intentions of the director and should always try to keep to the directors ideas, to only prompt changes when things are not practical or out of bounds to common sense. The designer is also in a similar position with the director and must set the scenes in keeping with the story line, to satisfy him and to be practical for lighting.

Annoyingly as it may seem, some directors insist on controlling the picture frames to such a degree that the lighting cameraperson or camera operator is controlled totally by the director. This happens a lot in television. Only close co-operation of the production team will produce the best results and one should always be willing to accept other people's ideas, you must be strong in defence of your experience and judgment.

Basic drama lighting plot

Fig. 20. The approach is always the same, attend the outside rehearsals and note every move and position of the players onto your lighting plan of the studio settings and use this copy underneath a sheet of tracing paper to plot the positions of the lanterns to be used for this production.

The setting I have shown is typical for a living room set and could be part of any kitchen sink drama situation, the positions of the lanterns are such that all practical positions of the players within the set is covered by the standard positions of the lanterns shown assuming a continuous shooting sequence. The lighting plot is almost universal for this type of production and will provide good results in almost any situation within a setting similar to this one.

With four cameras and two booms to contend with there should be no problems with shadows from the boom microphones, the two side keys at left and right on the set are dispensable but may be quite handy. The seven frontal soft lights may be selected as required as the convenience of having them in position saves any loss of production time. Night or day is easily portrayed by the combination of the lanterns provided, the addition of practical lights always help to establish night or day and the outside seen through the window also dictates that situation.

If one applies this lighting plot to any similar box shaped setting it will provide the basic lighting, which may be updated with the addition of extra lanterns for specific scenes. The dressing lanterns are fundamental and will remain an option, which may be added to as the requirements dictate. Play it safe and have all the lanterns in position that you may or may not need is always seems sensible and saves production time but there is always a limit to space and a limit to rigging time as well.

This is live television with live sound and yes it is recorded because mistakes are made and need to be corrected, live on air drama is a thing of the past.

To a film lighting person this method of lighting for continuous action may seem alien and not acceptable in pure photographic terms; I make no apologies because it is always a compromise to produce continuous non stop action in quick turn around serials for the medium of television in comedy, soap and kitchen sink dramas.

When more time is available to produce a box office television drama then the stop start shoots are in keeping with the resulting improvements in lighting and production quality, this goes for all aspects of the final results. Then and only then may real film lighting techniques are applied to the production.

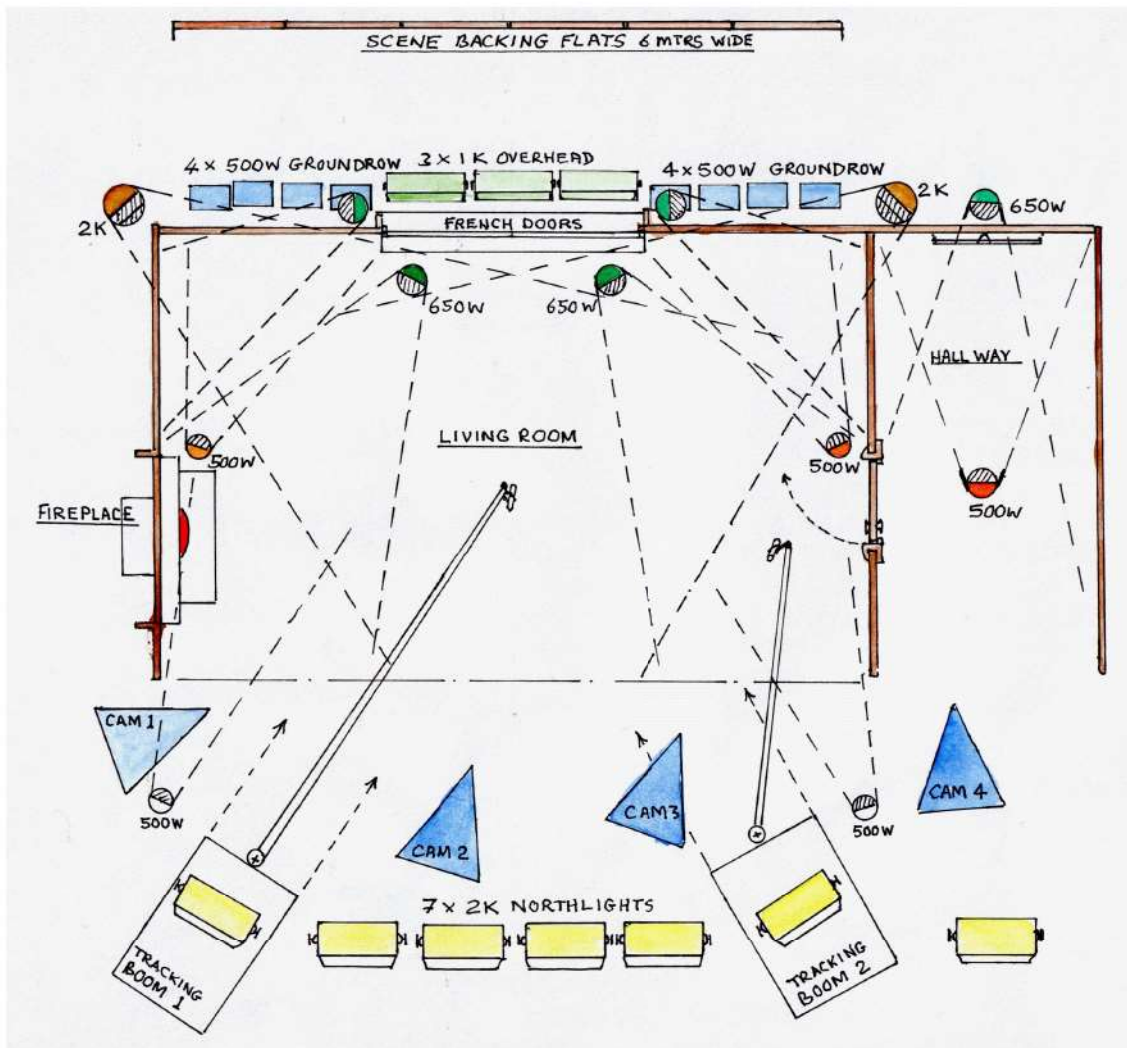

Fig. 20 Typical Television Soap or Kitchen sink Drama setting

Getting the overall balance of light

Balance is one of the final processes of lighting a production and summarises the preceding steps. Film lighting camerapersons and Television lighting directors are well aware that the mere placement of luminaries in relation to the artistes, the scenery and the camera positions does not result in either an artistic or well lighted show. It is the preliminary work, which really makes the show, excellence is achieved by good will and relationships to every one on the production, a lighting persons input has to be artistic as well as practical.

Luminaires must be properly placed and focused, must be most carefully adjusted in relation to each other. The lighting person must know every actor and actress in the production and all their positions on the floor for the completed production. Only by attending all the rehearsals will this be possible. It is most important that the lighting person stands in every artiste's position to adjust the luminaries with the light meters, spot meters, and monacle etc to use as required to maintain the lighting balance.

Generally the starting point is always the key lights they represent the 100 % intensity level and through setting skin tone of the faces controls camera exposure. The fill and modelling lights are balanced in intensity to the key light performing their functions in accordance with the intent of the scene. The greatest importance of the fill light and key light combination is to provide good illumination of the faces. As a general rule, the actor's faces are the most

important part of the production. In night scenes the facial expression must be visible if a meaning is to be conveyed.

Backlight is a critical balance item, Too much intensity may cause a wide variety of problems, flares into lens requires adjustment to barn doors or vertical height or the introduction of yet another gobo or flag, bad shadows, halos, badly lit faces, wrong accents, etc. Backlight should only be used to do its job of separating the person or object from the background with just enough intensity to provide this rim light.

Under cross key situations from the rear of the scene as often happens in television bottom scrims in the cross rear keys must be adjusted with great care to create an evenly lit area for the actors, in this instance the rear cross keys are also acting as backlights as seen by the cameras either side of the set, the rules are broken as both cross keys will be at the same intensity and therefore the effective back light is at the same intensity. This situation is only tolerated in television, because of rapid action soaps and serials with low budgets and fast turn around. It would not be used in motion film unless the same budget restrictions were applied.

Set and effects lights are usually easier to deal with as they are lighting the features of the scene and may be considered as secondary to the action and should not dominate the scene unless they are lighting features required to dominate.

Having completed the preliminary balance its time to re-examine the scenes during the rehearsal paying attention to the shadows, if there are no details in the shadows or they look very black its time to find out why, go and look on set, is there something missing does it need an extra luminaire perhaps or has a lamp blown.

For television ask the vision engineer to check black levels as electronically it is quite easy to loose details in the blacks. Ask if the camera angle has been changed before jumping in and changing things.

Adding light to the shadow areas must be cautiously applied, is soft light or hard light required? Check artiste's positions add the light, look carefully to ensure the problem is solved and has not created further problems.

For television balancing requires careful coordination with the vision engineer operating the camera controls, after the cameras have been technically lined up on the test chart, the camera exposures are set to match very closely each other, for rehearsals do not change these settings let the lighting person balancing the lighting get the best pictorial results on the television screens after all the camera is the best light-meter.

The use of the waveform oscilloscope by the engineer/operator provides a detailed display of the pictorial black, the facial tones, and the peak whites in the scene in terms of percentage above black, black is 0%-100% is peak white. Excessive highlights caused by specula objects such as glass, silver, or jewellery, and white table cloths or drapes, paintings hung on the walls with gold frames, brass work, all of these items will show on the picture and waveform monitors as spikes from black to white, which must be controlled, as they mar the picture as they lack details and just appear white. The items causing these unsightly blobs of white must be treated individually. Removing a pure white tablecloth and replacing it with a darker grey one is recommended, highlights on metal objects may be dealt with by use of dulling sprays. Glassware may also be sprayed if it's not a practical item, otherwise not much can be done about it other than changing the lighting or accepting the specula's.

For colour filming or photography, great care in balancing the light levels is needed due to the dimmers changing the colour temperature, if the fill level is too high put more neutral

density filter material in the front of the luminaire do not dim it. The same goes for the key lights, an extra wire scrim is better than dimming.

Always have spare scrim frames ready made for changing discoloured or burnt ones on any luminaire in the production, also have spare bulbs close to hand so delays to production are as short as possible.

Throughout the camera rehearsal the lighting person must concentrate on skin tones.

The expert Film Lighting Cameraperson pays very close attention to even very small shadows. Properly used, shadows create an artistic lighting mood; the whole image is produced by light and shadow on the screen. Unwanted shadows are most harmful especially the many small moving ones resulting from action passing through too many overlapping or improperly blended light sources, this is called “dirty light” a very apt description. To make the foreground seem closer than the background the foreground usually consist of well lit objects and the middle background relatively darker with the background picked out in highlights the colours used within the set often help to obtain this depth. Every situation is fresh and different and may only be treated by adjustment of the various sources of light for each given situation.

Good television and film lighting may only be achieved through creative application of sound principles.

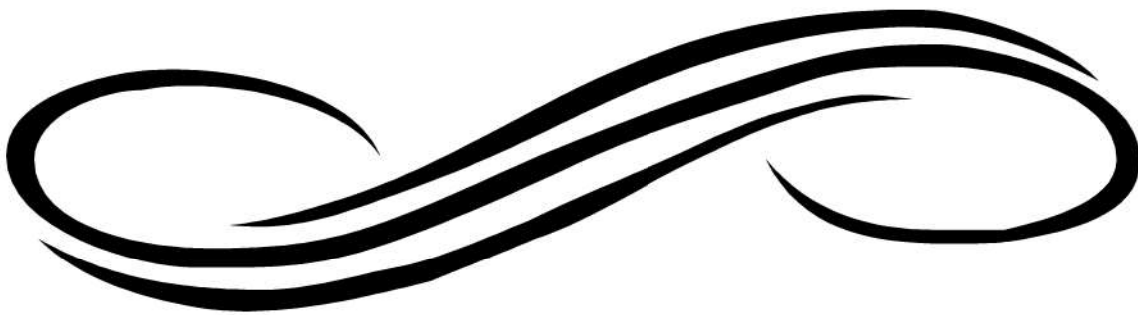

How to paint with light

This is a tough subject to explain because of the difficulty between the colours as in paints and colours as in light mixing. Two sources of light with two different colours will produce a third colour if they illuminate the same object, Two primary colours mixed together produce a secondary colour and the shadows will be directly related to the sources colour. This leads to some very interesting effects when a host of colours are mixed or blended on say a cyclorama. If done with care some very beautiful results may be achieved. Lighting a white square box on a white studio floor with three lamps, one with red, one with green, and the other with blue, will produce a white surface on one side of the box, and differing colours on the other sides also the shadows will be mixed but will include parts of the original primary colours.



Lighting by “John James” for “Time Travellers” at the Maidstone Studios. Key light levels 75 ft.c, Film camera F4.5 at 1/30th with a 400 ASA Fujifilm. Sony Broadcast digital CCD Television cameras F 6.3 at 25 frames per second.

When viewed through a television camera system the colour version may look great but the monochrome picture may be very disappointing.

My choice for primary colours “Permanent Rose” for Red. “Cadmium Lemon” for yellow and “Windsor blue” for blue. To create depth within the scene by the use of colours, my choice would be graded dark to light blue for distant background, medium or mid blue and greens for middle distance, golden to light browns and yellows or reds foreground. The picture below confirms my opinion on the colours used to create depth in a two dimensional system.

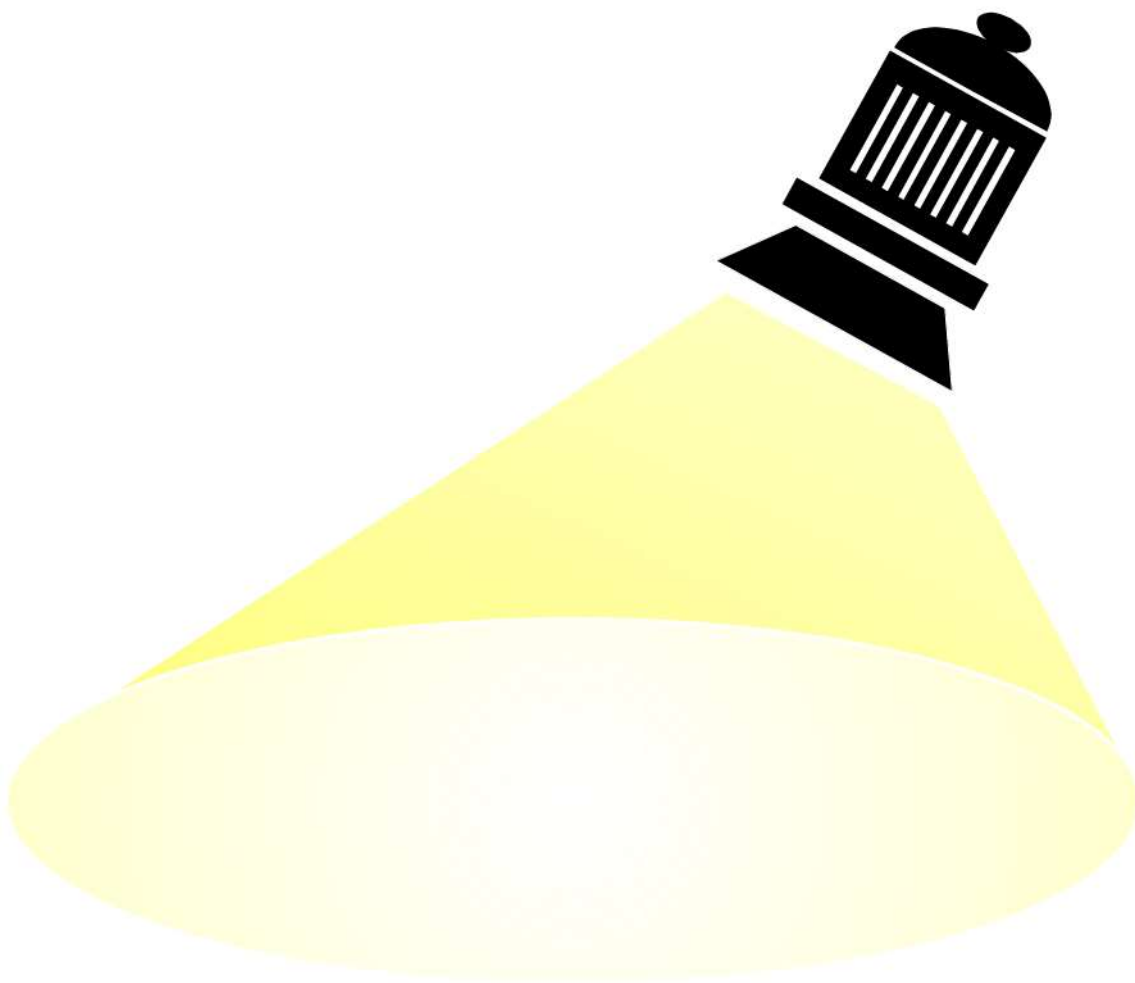

Orchestral lighting for television

What I would consider to be the safe way to light an orchestra as I have used this method at many orchestral concerts around Europe on locations such as-

The R.T.E Television Studios Dublin, The National Theatre Dublin, The Royal Albert Hall, The Royal Festival Concert Hall, The Vienna state opera house, The Berlin State concert hall, A Christmas concert from Bethlehem, These are just a few of many places.

Conduct a survey of the concert hall, opera house, or theatre and find out first and foremost the orchestral seating plan and the numbers of players. Find out who sits and who stands and where the action takes place. You will need a plan of the building because without this it is extremely difficult or next to impossible to even approach building a lighting rig. Find out the suspension points within the hall for additional lighting and which Boxes on the wings or balcony areas that may be designated for lighting and the required scaffolding or towers to be constructed to support the lanterns. Access is very important for all this heavy equipment. Suspension of lanterns from trapeze wire supports in the roof must be found and related to the floor plan of the building. For if you are to use these supports research must be done to find out the working loads at these points. Mark on your copy plan all supporting positions available, then you are able to position the barrel supports for placement of the lanterns near where you desire them to be.

My advice is not to get bogged down by the apparent complexity break it down into section, plan the lighting of each section and use the basic rules of lighting.

“Keep It Simple”

Use the lighting stencil Fig 21 as the basis for lighting each group of musicians; you may need four 2K or 5K lanterns depending on the distance from the musicians and how many persons are in the row and how much light level is required.

This could include two rows one behind the other for economic lighting but it takes away the ability to control the lighting on individual groups of musicians, Violins, Violas, Brass, percussion etc.

The angle of each lantern used as a key light should not exceed 45 degrees to the horizontal and the angle to the side of the faces of each musician is also about 45 degrees as used with cross keying. The reason to use this method of cross keying is based on the fact that musicians need to see their music clearly and also see the maestro (conductor) without being blinded by a low angle straight in key light, you can bet they will complain with very loud voices and go on strike as they are in general very temperamental and this is not a good start to your day. That is why I called this a safe way to light an orchestra.

The backlights are just as important because you must never get hard black shadows all over their music; by crossing over the backlights at 90 degrees to each other this avoids any problems with shadows. The lights on the music stands are quite effective and blend with the backlights.

As you work from the front rows to the back rows the backlights become very steep due to lack of distance between the last row of musicians and the rear walls so they actually are more like top lights, in this situation the very back row would be 2K lanterns or even 1K lanterns as top light, the light level required is much less than with backlights.

Lighting the grand piano has already been discussed, for lighting the solo artistes apply the three point lighting plan and use a hard source as a supplementary soft light by fitting a scrim to soften it and a snoot to confine it.

You will not be able to use any form of fill light as a general source without huge objections from the musicians and the audience because it kills the atmosphere.

Lighting the audience separately is often required and is best done with some wide-angle PAR lanterns as the most economic method, 9 lights 'minibrutes' positioned at strategic places around the hall or on the upper balcony or in private boxes, and also at high camera

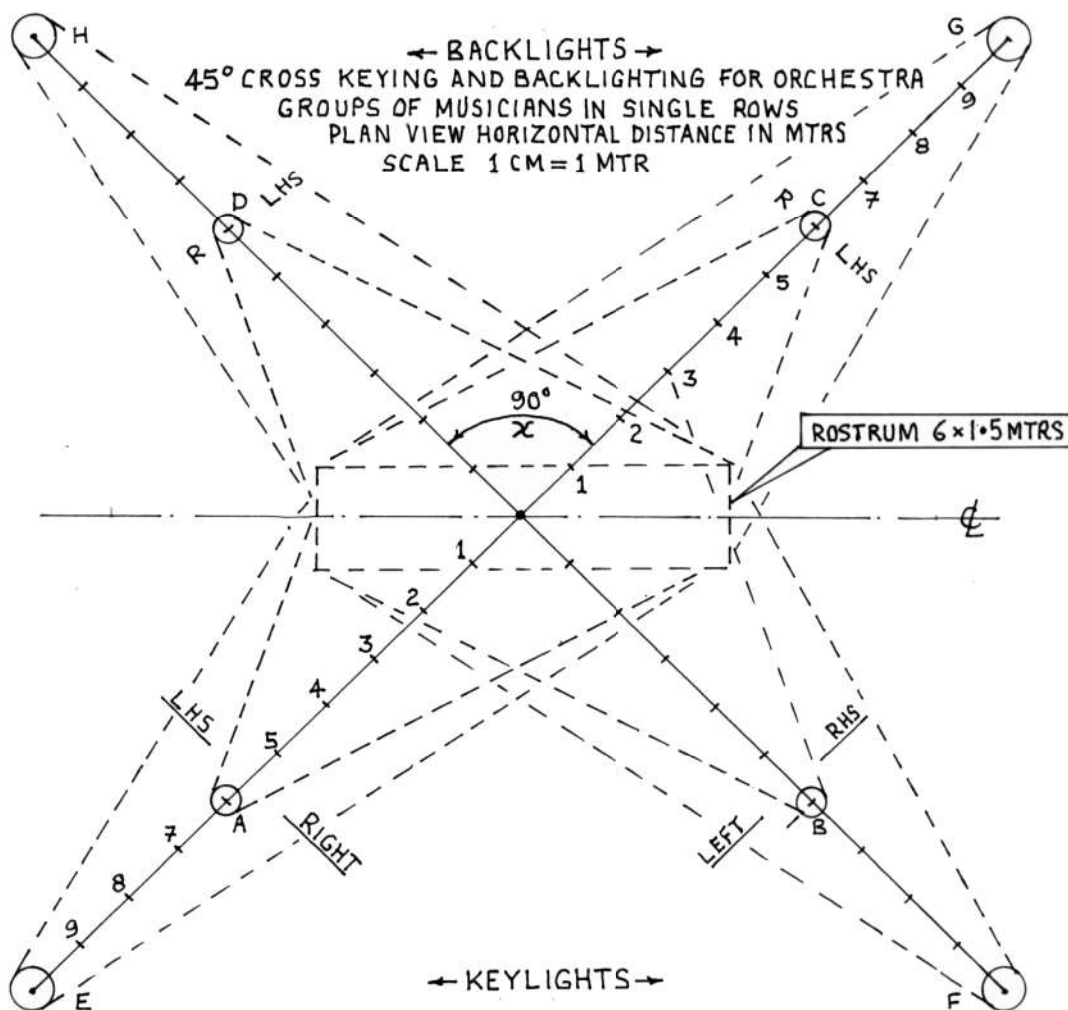

Fig. 21 A special Lighting Stencil for lighting the rows of musicians on the Orchestra plan. The Key & back Lights are at 45 degrees

positions, will generally do the job very well colours may be added for mood control. The audience lighting would never be left on during a performance.

Lighting the Maestros (conductor) grand entrance and exit is normally done on a follow-spot but during the performance the spot must close the iris and fade to black whilst a separate four point backlight and key light combination must be brought on to light the conductor's rostrum, quite steep angles are used with these lanterns as they must light only the Maestro. The four lanterns should not be visible in the eye line of the musicians when looking at the maestro. The same applies to the maestro when he looks at any of the musicians. If you transpose Fig 21 onto a piece of tracing paper and scale it to the building drawing this will provide a stencil for getting the positions of the lanterns accurately placed on the lighting plot. Try to avoid very long focus paths from the key lights, as the distance increases the edges of the lit area become less distinct and the barn doors less effective. Lighting levels are governed by the camera lenses and if the cameras are a long way from the action the use of long range zoom lenses will require a reasonable working depth of field subsequently the F stop will need to be at a minimum of F 5.6 or better. 100 Ft.c is a good incident light level to aim for.

The following stencils may be made at home using some clear gel or acrylic sheet materials to be marked out with a type F STABILO-OHPen 842 universal permanent waterproof indelible pen available from any art shop.

- Lanterns ABCD = 2 K @ Full flood. Lens angle 45'. Ht chosen 8.25 metres.
- Lanterns EFGH = 5 K @ Full flood. Lens angle 27 – 55' max, set 27', Ht = 11metre.
- 2 K RHS beam length = 11 metres, incident light falling on centreline = 25 ft.c.
- 2 K LHS beam length = 5.5 metres, incident light falling on centreline = 150 ft.c.
- SUM of A+B & C+D = Centre of beams 75+75 = 150 ft.c.
- SUM of A on RHS + B on RHS = 25+150 = 175 ft.c.
- SUM of A on LHS + B on LHS = 25+150 = 175 ft.c.
- Check out the scale factor of any drawing so that distances are related
- Thus a single diagonal half wire scrim placed in the LHS of 2 K "A" and the RHS of the 2 K "B" which will even out the light level all along the centreline to 150 ft.c.
- The 5 K Lanterns EFGH will provide 150 ft.c with focus set at 55 degrees, or 200 ft.c for a 27 degrees beam width along the whole of the occupied centreline.

The backlighting pattern is identical to the key lighting as a mirror image and you may use 5 K lanterns as keys with 2 K lanterns as backlights.

Use this stencil in relation to the following graphs of light levels versus distance along the horizontal, do not confuse with the beam length of the lanterns.

Lanterns 10 K, 5 K, 2 K, 1 K, will vary in light output depending on the manufacturer and the type of fresnel lens fitted to the lantern. Take into account the difference between tungsten bulbs and the higher output of quartz halogen bulbs. There are three graphs shown for the 2K lanterns as there are some measurable differences between the manufacturers.

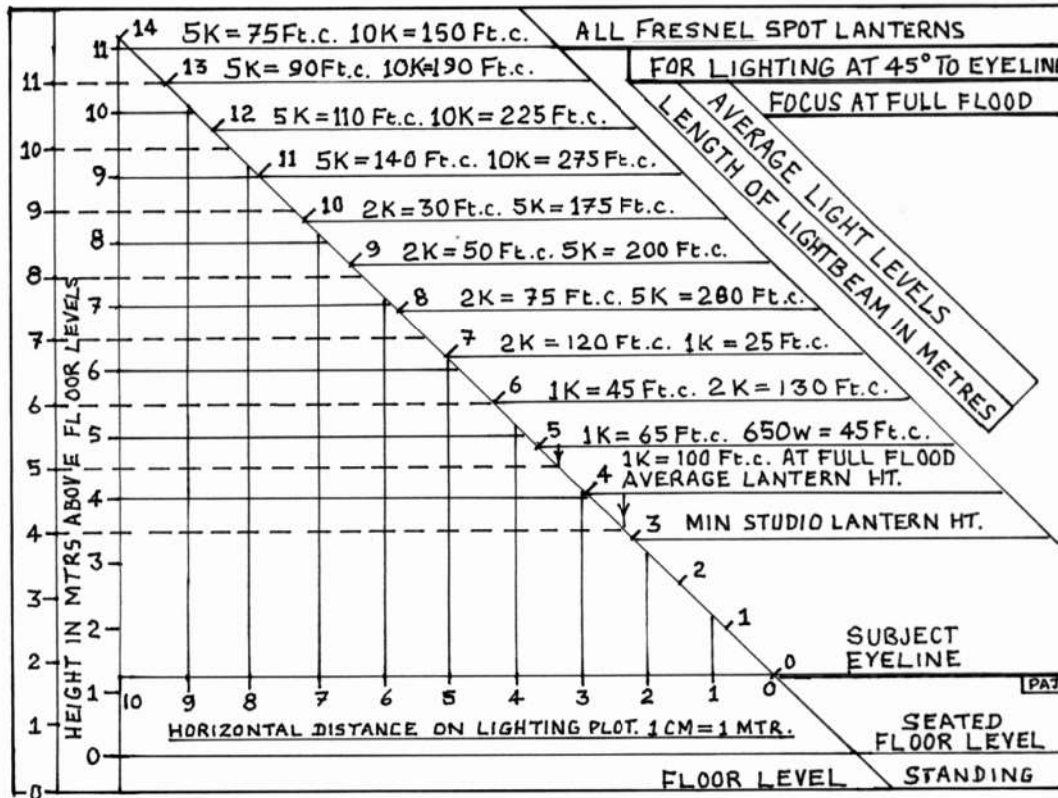

Fig. 22 Graph for various lanterns relating beam length at 45 degrees to the horizontal distance.

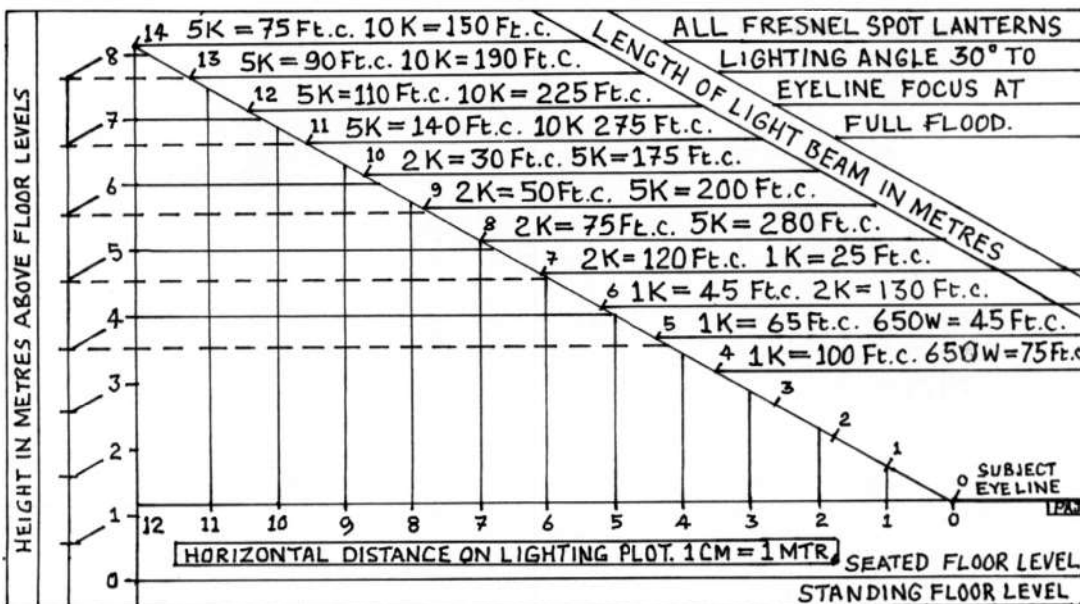
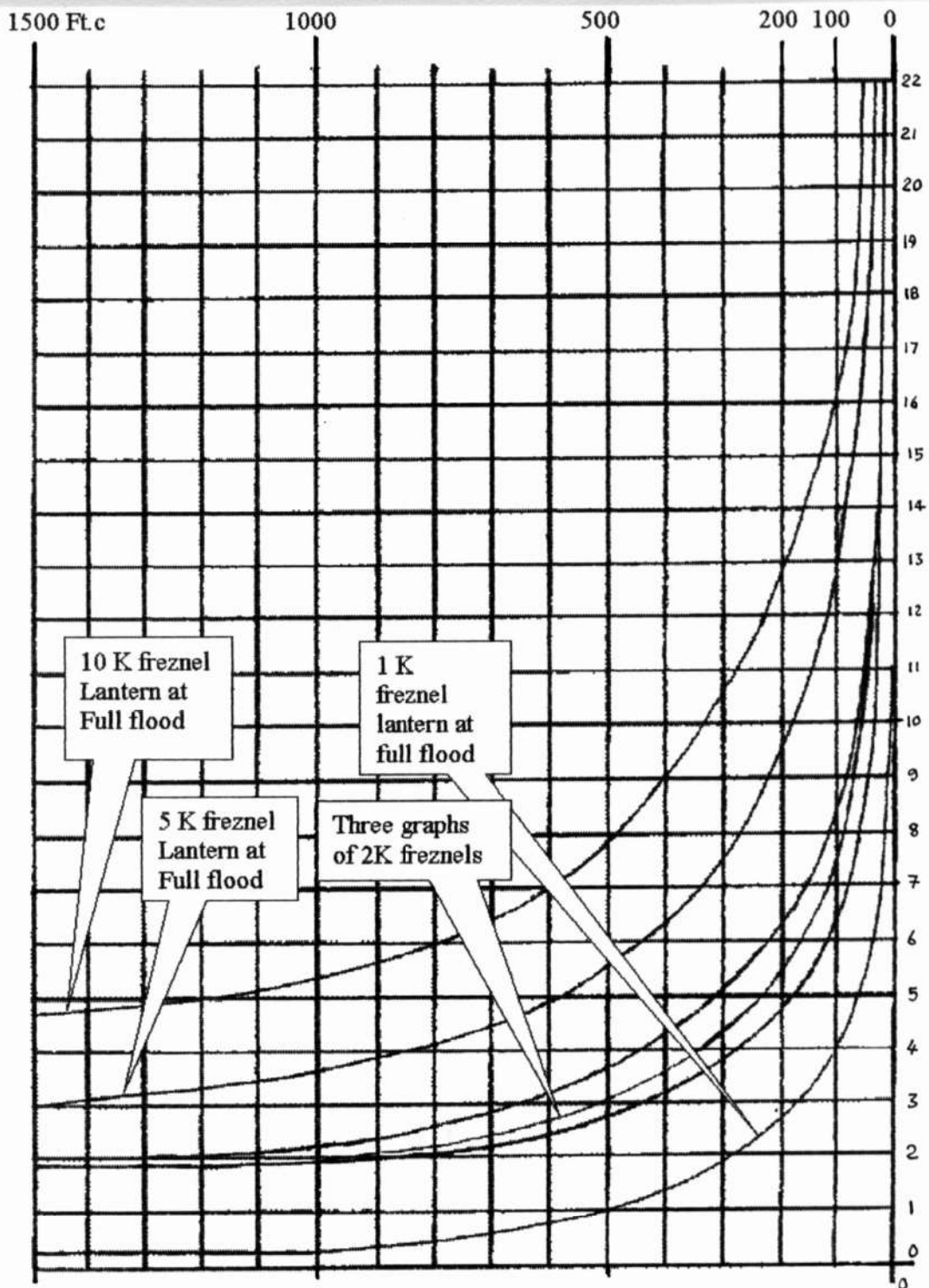

Fig. 23 Graph of various lanterns plotting beam length at 30 degrees to the horizontal distance

Fig. 24 Graphs of average light levels in ft.c for lanterns measured at full flood versus the distance in metres.



Scale, 1 metre equals one square on the base line

BASE

Base line 0-22 metres, each square = 1 metre.

Vertical 0-1500 ft.c (each square = 100 ft.c increments in 15 squares.)

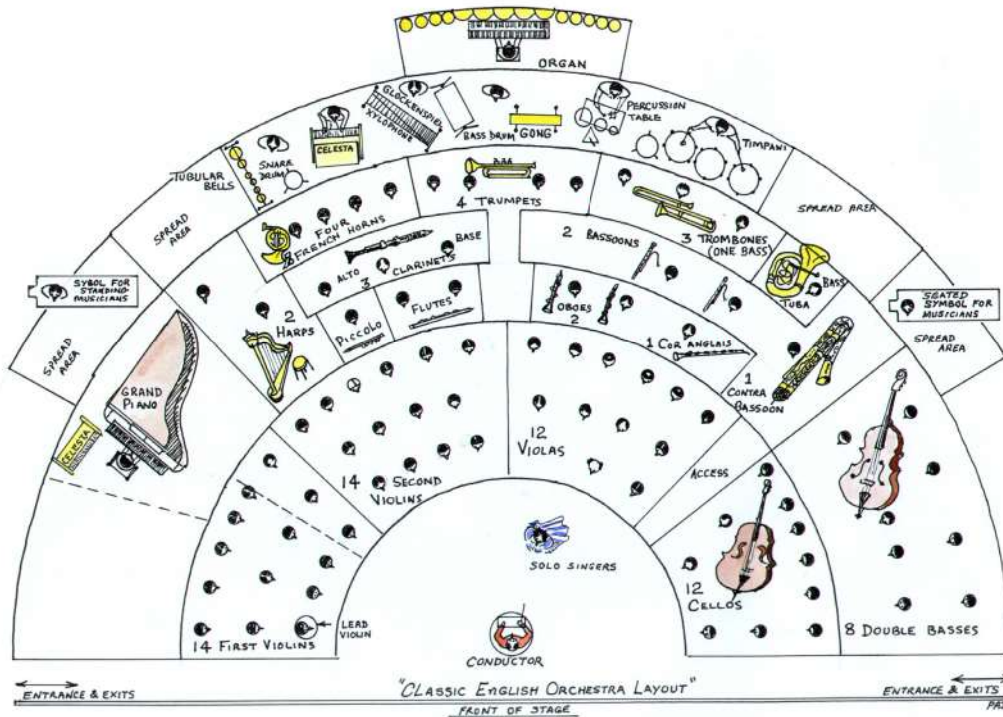

Fig 25 typical layout of an English Orchestra. The drawing portrays the English orchestral layout often used at the Royal Albert Hall for this and many other venues elsewhere.

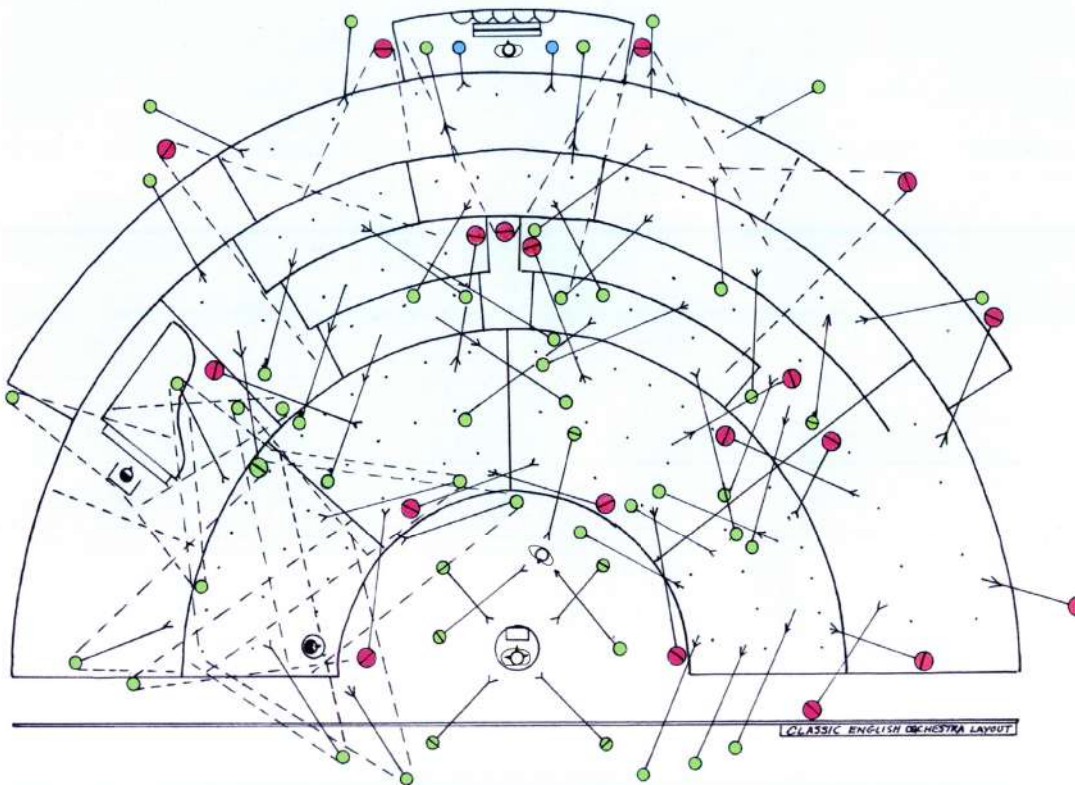

Fig. 26 The lighting plot for an English Orchestra. Shows the lighting plot in its most complex form as plotted and used by myself, it is not exactly to scale as this has been recalled from historic hand drawings and notes made at the Royal Albert Hall.

The red circular dots are 2 K lanterns the green and blue circular dots are 1 K lanterns for a lighting load of 100 Kilowatts and for an approximate lighting level of 50 ft.c incident light level. For a lighting level of 100 ft.c, change the 2 K lanterns for 5 Kw lanterns and the 1 K to 2 K lanterns. Please note that this decision, will double the power load to 200 Kilowatts.

In the example drawing for an English orchestra layout the setting is typical of the Royal Albert Hall and at first glance it appears extremely complex.

The lighting plot is even more complex and contains all the lanterns needed to light each row of each group of musicians. I have used the four point marking system to position the lanterns by the use of tracing paper marked out as shown in Fig 21.

As the height and distance at 45 degrees are equal you must establish the height for all the lanterns in order to mark the horizontal distance to the subjects on the plot.

This all depends upon the building in which this takes place and the levels at which the musicians are placed. The rostrums rise towards the back in a grand sweeping steps of 70- 80 cm's for each rostrum.

It is not required to place as many backlights when some areas may be covered with less lanterns, when some backlights will cover two or more rows quite well there is no point in putting up more lanterns than is needed this does apply to key lights as well.

The next major problem with this plot is hanging the lanterns from the roof and as I have said before a plan of the building must be obtained to ascertain all of the suspension points, then and only then build your lighting plot so it will become obvious that some of the plotted positions will need to be moved. Sometimes it is extremely difficult to get the exact positions, do not despair as many other solutions may always be found, compromise is sometimes an asset.

Lighting an orchestra with diffuse soft light

Another way to light an orchestra is to use overhead Chinese lanterns with a 3 or 4.8 Kilowatt rating for each one. Some 20 or more are required to be hung to produce a large area of soft light all over the orchestra. These lanterns may be very colourful and pretty in appearance, about 1 metre in diameter with a drop of 2 metres, six 500 or 800 watt linear bulbs on wheel shaped frame inside a white linen bucket shape bag as shown in sketch below, the bottom may be covered as well but is normally left open for ventilation. Add to the lighting rig a ring of backlights and set dressing lights of various colours to make quite an attractive and enchanting scene for a light entertainment night out with orchestral music in concert.

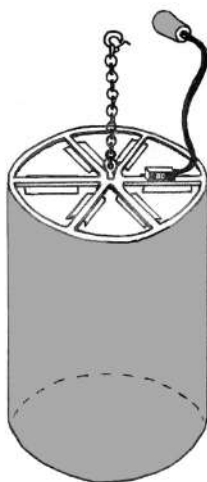

The Chinese Lantern is made from a metal hoop about 1 metre in diameter with six radials supported in the centre by a chain or wire lanyard, each radial is fitted with a downward facing linear reflector and bulb holder. The skirt is attached to the rim of the hoop and could be made of fibreglass cloth with decorations painted on it.



Television lighting

One of the main problems faced by the film lighting cameraperson trying to film a stage production is the total lack of light level of any significance. There for it is very seldom that a stage production would be filmed. Rather a film adaptation might be considered and carried out in a film studio. However for television it is quite a different story, there is often enough light to work with and supplementing it with additional lighting is quite rewarding. Placement of the additional lighting is very difficult as the theatre barrel suspension system is often full of lanterns used in the stage presentation.

Arrangements have to be made to provide additional barrels or “pipes” to be suspended as specials and any space within the wings to be taken up by the use of vertical pipes with suspending arms for the additional lanterns. The proscenium arch may have lighting above it and if there is room, base-light needed to lift the low level light scenes and may be placed there. It is very important that clearance is given to any scenery that is flown in or out. F O H front of house lighting for the television production may mounted on balconies and in side boxes and in some circumstances within the band box or “Pit” below the stage, Some theatres have suspension systems above the auditorium for F O H spot lamps and projectors. For television this is most useful for audience lighting and front of stage lighting when covering a stage production the audience would be specially invited and many seating areas reserved for television cameras and lighting. An additional A C generator of the silent type may often be required to power the television production vehicle and the additional lighting if the theatre cannot provide the power.

Lighting designers of theatre and stage

Much of what has been said is of use to stage lighting, but the artistic licence of stage lighting is very different and quite a different medium. The lighting designer is allowed to do any thing with light, there are no limitations, no colour temp to bother with no contrast range to worry about and any colours may be used from dark purple to blackness, with glow paints! The reason for this the light show is to please only the public EYES and to create illusions, So when a show is to be seen on television a whole new approach to the lighting has to be found and many things cannot be recreated exactly as in the stage version, much to the horror of the theatre lighting designer.

Lighting for the theatre is one art form, lighting for television is another

This problem often arises at pop concerts and often becomes a battle of will power between the pop band lighting designer and the poor relation in the guise of a television lighting director who is responsible for the television coverage, but is not responsible for the content. One thing the television industry has learned from these types of coverage is to record separately the output of every camera for the whole event.

After the event the various recordings may be edited and pieced together thus avoiding the unforgiving lighting effects and poor shots that may have occurred during the live performance and a neatly packaged show for transmission on the television network or transfer to Digital Versatile Disc for public sales should be the result.

Television studios

Life is more relaxed in television studios because the method of lighting is quite advanced over that of most film studios, some Hollywood film studios have comparable lighting systems to television studios because they use TV cameras as well as film cameras. Inside most television studios the whole roof of the studio is fitted with a grid which supports tracks in which telescopes or pantographs are positioned for individual luminaries and may be suspended at any height above the studio floor, there is also a cable within the telescope to raise and lower it by winding a ratchet drum to take up the slack these telescopes may be positioned anywhere above the scenery and this is usually done after the setting of the scenery. Some studios are fitted with a boat system and this works in a similar way and they may be raised or lowered by remote controlled motorisation, each boat may have six or eight luminaires permanently attached and may be remotely switched on or off or dimmed by the lighting control console. This method has been in use quite a long time and has proven to be the better system by reducing the turn around time between productions. It does lack a bit of flexibility at times in getting the ideal position for the luminaries. This is often overcome by fixing luminaries to the scenery they may be mounted directly onto the top of the scenery flats by the use of female spigot clamp which is a vice like attachment able to support the cradle spigot of the luminaire. A gaffer clamp does the same thing but does not support large luminaries. The luminaires are powered from floor distribution boxes mounted on the studio walls at convenient places. Some luminaries are mounted on stands on the studio floor for special production reasons.

Within a television studio the lighting rig might consume up to 100 or 200 KW's of energy 50 % of this will be heat so there are limits to the amount of energy that may be used, the limits are due to power supplies and to air conditioning requirements, some times all lights need to be switched off to cool the studio and equipment and to provide a break for all the people working in the studio.

Lighting levels in television studios

The light levels required at different studios will vary quite a bit, for example the Maidstone television studios now work quite happily at 25 ft.c incident measurement of the key-lights, and subsequently the studio temperatures are very much better controlled over the long shoot periods and subsequently much more comfortable to work in.

The low light levels used are entirely due to the choice of the very latest CCD colour cameras and a combination of very fast zoom lenses providing a good depth of field at very wide apertures. A CCD Camera working at F 5.6 may only require about 10 ft.c of incident light to produce a perfectly acceptable broadcast colour picture. However the camera crews prefer more light for better depth of field and 50 - 75 ft.c is more normal.

Film cameras also benefit from the fast lenses available with a true f 1.4, when for a very long time low F-stops such as this were not possible on a zoom lens. This is due to complex computer design and advancement in the science of lens manufacturing.

As the lighting director has the choice of lanterns for any production within a studio the lighting itself becomes so much more flexible, lighting can be achieved with real practical fittings which provides more realism to the scenes.

The Maidstone studios

Once owned by TVS to provide a television service to the south and east of England. The Studios became independent after the loss of the broadcasting franchise and are now owned and run by “Dovedale Associates” with Geoff Miles former BBC producer as managing director.

The studios are very well equipped for both television and film productions with plenty of space inside and outside. Studios 1 and 2 use a motorized lighting boat system for lighting and carry a large stock of different types of lanterns.

The control rooms are well fitted out for any type of television production and have the very latest digital systems for sound and vision in all aspects of editing and production.



“Time Travellers” for “Red Door Productions” at Maidstone studio 2. The Presenter Lawrence Leyton on the left with guest. Lighting by John James, Design by Val Jones.



Maidstone Studio 2 Production Gallery



Maidstone Studio 2 Lighting and vision control



Maidstone Studio 1 Production Gallery



Maidstone studio 1 Lighting and vision control



Strand Galaxy lighting control consol



Electrician's set-up control panel and pin patch for checking out installed lanterns during the rigging time.

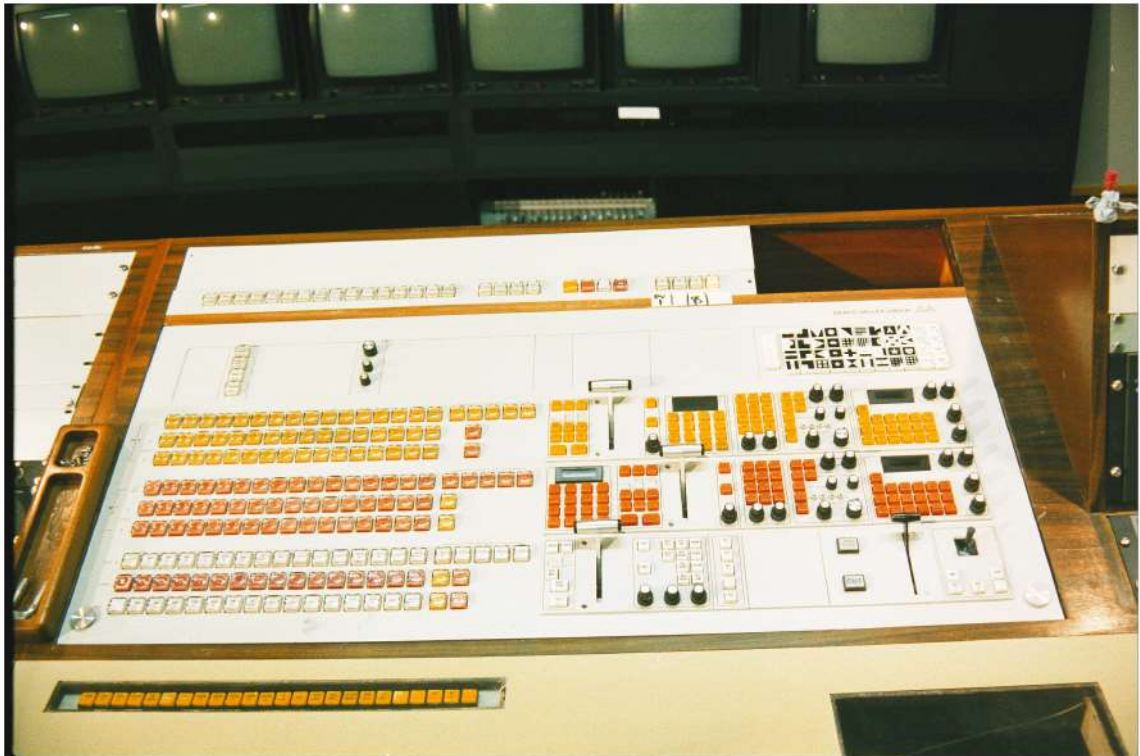

Grass valley vision mixer in studio 1, Maidstone studios. This type of vision mixer has now been superseded with a digital vision mixer, which offers a range of visual effects, which do not suffer see able edge effects on inlay transitions and now provides seamless transitions and merges of visual content.



The Maidstone studios, Vinters Park, Maidstone, Kent.



A Television production control room showing the colour monitors, electronic vision mixing desk, with the operator Ross Story demonstrating some of the special effects, Pictures made at the Television International studios Whitfield Street London in 1983 the last year of the studios existence.

London News Network “London Tonight”

The London Studios

The LNN Television Studio is quite unique for its panoramic view of the city of London, the whole of the north and east side of the studio was built with large plate glass windows to provide a live and moving backdrop for the news presenters sitting at their desks. Much activity may be seen along the river Thames and along the Victoria embankment. Blackfriars Bridge and further, northeast St Paul’s Cathedral and the city skyscrapers.

This sets quite a challenge for lighting as during the summer months and in the early mornings, sunlight streams into the studio. It was decided not to colour correct the windows but to colour correct the lighting, special mesh curtains are installed which are drawn across the windows to reduce the daylight by 50%. A further reduction of 50 % is achieved by adding another mesh curtain when required. It is quite important that the mesh is not too close to the windows as this helps to reduce reflections. On a very bright day the background seen through the windows may be anything from 500 to 1000 ft.c incident light level, this coupled with endless variations of weather conditions over the year often may bring the light level at midday well below 50 ft.c. At night time the mesh curtains may be removed to provide a view of the city lights as the backdrop. The ability to obtain these views, night and day all the year around is a prime directive for the lighting and camera systems installed. Another obvious problem with the glass panels at night time are the reflections from within the studio of other lighting equipment that may be seen superimposed in the various camera shots, a selection of large black screens are placed into various positions to avoid the reflections being seen, quite large black gobo’s are hung in front of lanterns suspended from the lighting grid to avoid seeing the key-lights and soft-lights as reflections above and behind the presenters.

For ease of control of the complicated lighting, a switch panel is also installed within the studio to select the remote controlled dimmers which route power to the power sockets for each lantern installed on the lighting grid overhead. All the lanterns are pole operated for adjustment of focus pan and tilt, a person is still required to climb a ladder to set barn-doors or to replace or change gel frames and bulbs.

The lighting equipment consists of 5K, and 2K, Fresnel spot lanterns as key lights and backlights with Strand quartzcolor 5K soft lights, an assortment of dressing lanterns for ground-rows Cycloramas and Chroma key backings.

In order to cope with the huge variations in light level coming through the windows behind the presenters and the changes in colour temperature, camera ND filters and colour correction filters are selected remotely or locally at the camera.

A horizontal line of lanterns used as key-lights and soft-lights facing the presenters are set with quarter blue, half blue and full blue gels, the key and soft lights to be selected individually

by the lighting operator's in the studio or by the duty vision-lighting control engineer via the remote controlled dimmer system.

At night the lanterns with blue gels are either switched off or reused without blues, or alternatively preset lanterns without gels are used to provide tungsten light at 2000-3000 K to match the outside building illumination and street lighting in the background.

The camera colour balance is adjusted routinely to match the scene, with frequent use of a grey-scale test chart placed to be lit by the key lights is used to maintain the camera colour balance. The cameras have remotely controlled iris and black level for the vision-lighting engineer to adjust the picture quality.



“London News Network, LNN” Studios for the London News. Presenters Lucy Alexander and Alastair Stewart

The studio is fully equipped to cater for musical events such as pop groups and bands, discussion groups, and interviews etc. “The London Weather presenters” use Chroma Key video inserts and green seems to be the favourite background colour for the Chroma key. The News and Sports broadcasts use special desks which contain hidden transmission display monitors and computer monitors under the transparent surface of the desks, communications are also built into the desks for production talkback and news room updates.

All the presenters are fitted with radio earpieces and radio microphones for two-way conversations on live transmission and with live hook-ups or outside broadcasts, visual Teleprompters are fitted over the camera lenses providing a running script of the events being presented.

Note the colour balance is decided on the face tones consequently the outside scene is predominantly blue and so are the reflections on the glass top desk. The key lights and fill lights are fitted with blue gels to match the colour temperature of the outside scene but

fall short of the 5400 K temperature required this is a compromise as the daylight changes throughout the various program times.

At night the lights with blue gels are dimmed off and a second set of lights without gels are faded up, this may take place as daylight dwindles to dusk and as the street lights and tungsten flood lights in the background outside are the only source of illumination for the outside scene, the studio operates at night with a colour temperature of around 3000K. The 50% mesh curtain would be pulled back to clear the windows for the night programs.

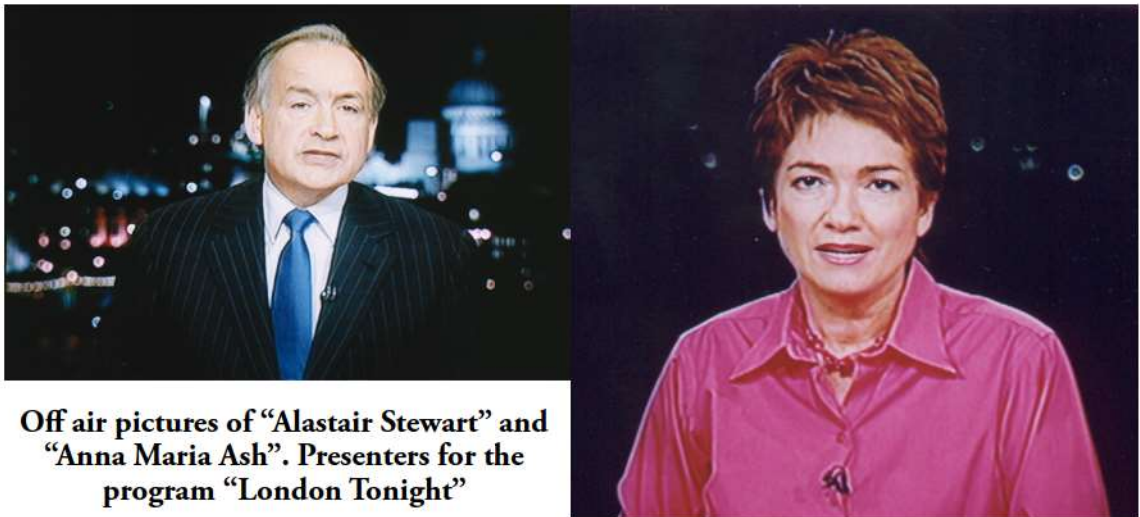

Off air pictures of “Alastair Stewart” and “Anna Maria Ash”. Presenters for the program “London Tonight”



Newsreader and presenter Paul Green at the LNN studio



Newsreader and presenter Lucy Alexander at the LNN studio



LNN Production gallery used for the "London Tonight" news program



Studio windows The Left hand side has a 50% reduction in light due to mesh curtain and the right hand side a full exposure to daylight through clear glass. The camera takes the clear shot of the City for cut away shots within the show; the level measured 250 ft.c left and 500 ft.c right, separated by the dividing upright of the window.



LNN Studio lighting for London tonight news desk

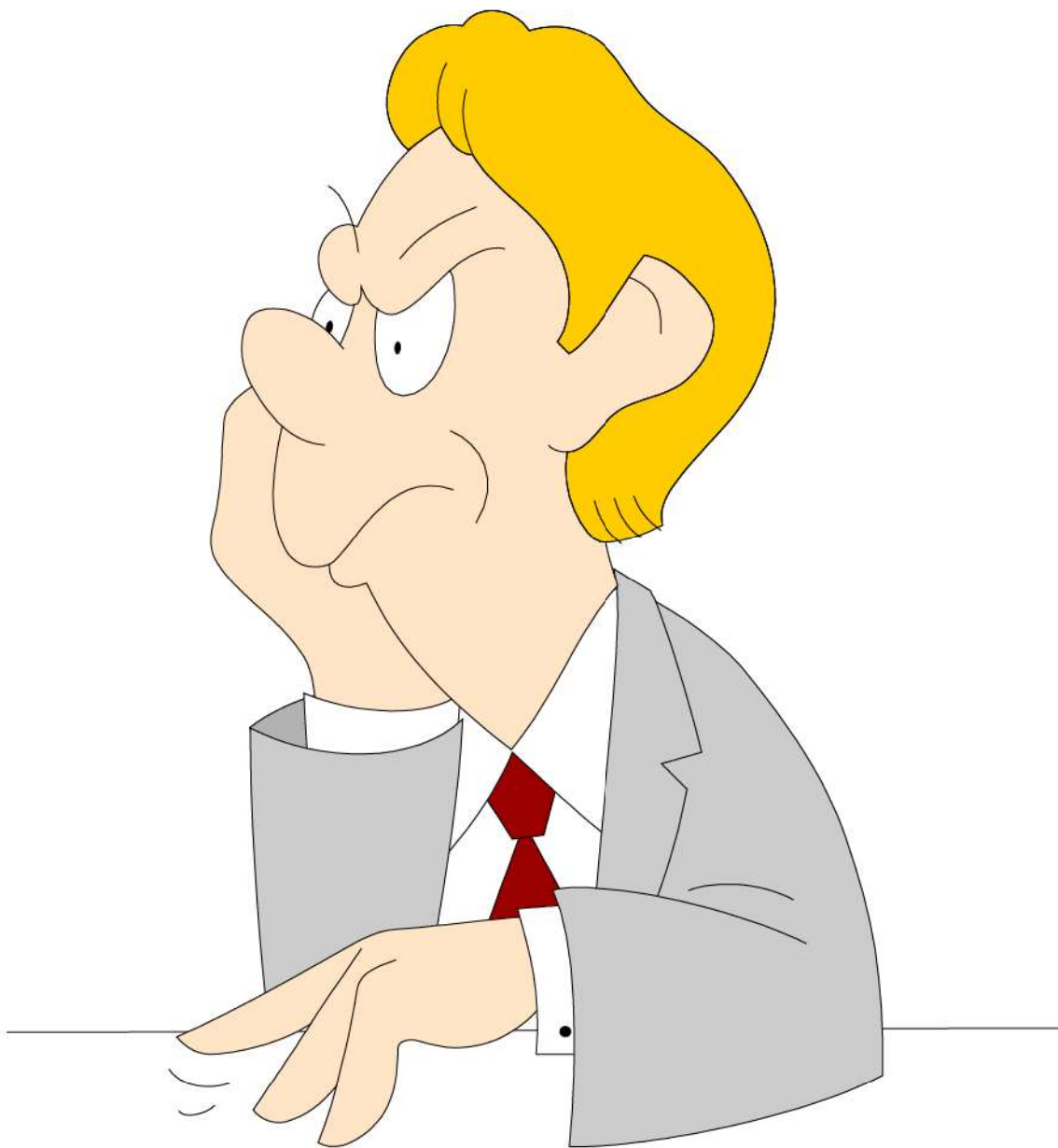

Television inside locations

For location shoots within buildings these new CCD cameras and lenses are a godsend as rigging smaller lanterns makes the job so much quicker and far easier to control thus reducing the cost and the bills for power consumed.

A fine example for anyone to view are the pictures seen on the public television broadcasts of “Crufts” from the NEC Birmingham, and with the portable CCD cameras working under available light which consists of a mixture of daylight and orange sodium artificial illumination which at night time only provides about 10 ft.c general illumination over the vast floor areas. In fact the lighting could be described as awful; it is quite amazing that the picture quality is so good under these conditions. Interviews are seen to be done with PAG lights mounted on the cameras these are battery operated and I doubt if the light level exceeds much beyond 20 ft.c incident measured from the PAG light at the position of the presenters or interviewers face, if the light level is too high on the presenters the backgrounds would look dark when compared to the general wide shots of the presentation areas.

Studio settings

In a multi room house within a studio each room is spread out around the studio floor, the scenic designer will try to position each room in relation to the others. The lighting cameraperson must ensure continuity of lighting between rooms. Upstairs downstairs must flow with the lighting it's very easy to disorientate the viewer if you make a mistake. The light from a real lamp in the middle of a table may be simulated from the light of a luminaire hung from above. A chandelier is best with all its bulbs working; ordinary candles are a real pest as they blow out, and cause time problems, props must use special effects candles that relight themselves and don't burn down.

Set dressing is done by the set designer so don't move things without asking, and continuity is also a job carried out by person made responsible for it. If you move lights from scene to scene make sure the lighting continuity is maintained.

Scenes through open doors or archways is often one of the most difficult lighting jobs to do realistically because you may have to match outdoor scenes that have been recorded (or pre filmed) this requires a replay to compare your shots and to match the lighting. The scenic designer is often forced by studio space limitations into compromising situations and perhaps the garden is a painted flat backing, it would be a giveaway if there were shadows of the artistes falling onto it as they passed by it. There is also the danger of the artistes walking through the backing illumination this must be avoided. The colour temperature of dressing lights not involved with lighting artistes is not as important as the acting areas for the lighting person but could relate to the colour of the scene sets and the scenic designer.

Smaller independent studios

Many of which co-exist in major cities as independent production facilities along with the major broadcasting studios and often provide cheaper hire costs for independent productions. Often the studios do not have lighting grids and make use of suspended scaffold barrels on which to hang the luminaries, various adaptations of this system will be encountered; the height of the interior of the studios should be a major concern to the Lighting person as this may restrict lighting options for the production proposed. Access must also be taken into consideration, including the parking for unloading and loading vehicles providing all the production requirements.

Setting up a temporary lighting grid

The production that you may be asked to light could be set in a hall without any form of suspension available from the roof and no better power supply than a 60 amp switch fuse with no spare capacity. Get a generator and the power supply problem is solved, "Get a lighting grid" Well yes it is done all the time for pop concerts. Building a scaffold system is part of the business of lighting, and may be carried out in many ways, the lighting hire companies are able to do most of these things and carry special pre made vertical supports and cross beams all specially designed to take the huge weights involved. When in doubt consult with the hire people. For small jobs the lanterns may be mounted on heavy duty stands with "High Lifts", these are extension tubes added to the stand and are able to get a 2 K up to 3 or 4 metres in height above the stand height, the stand must be weighted at the bottom with at least four 56 lb, or 25 Kilogram scene weights to make sure it does not fall over if it is free standing. Chain or rope Tiebacks should be used where possible to retain any stands from falling over.

Projectors

Television colour projectors may have similar problems to the film projectors the picture is not very bright at 120 ft.c highlight brightness, however this does depend on the size of the screen and the type of projector. Modern L C D colour projectors do not present any synchronization problems and are useable in most television studios for rear screen projection. Be aware that synchronization is difficult to deal with and requires expert knowledge when dealing with motion film projectors for rear screens.

Projector brightness is normally quoted in ANSI lumens this represents the light emitted from a perfect reflecting surface or screen of a given unit size and area.

Plasma television displays are limited by their size but are superior to other types of displays because they have flat screens and are bright enough to be filmed or seen by a TV camera, without flicker or sync problems. This is due to the use of a digital display as opposed to a scanning display (Digital storage used between the read and write process).

Television daylight display screens

There are very special television picture displays that use digital control of miniature high power lamps they use a combination of red (green or yellow) blue and white mirror back projection lamps and will match daylight levels of light, these are used in stadiums around the world and they cost a small fortune to purchase. They are available for hire as mobile units and are often used for pop concerts. Newer versions use Super high brightness Light Emitting Diodes (LED's) which are now produced in White, Blue, Red, and Green, they have a much longer lifespan than any other artificial sources of light.

Studio facilities

Nearly all television studios are well equipped with a good selection of lighting equipment, technical help from crews of skilled persons in all the aspects of studio productions, plus work shops and paint shops, stock scenery flats and a props, wardrobe department, Art and graphics, dressing rooms and greenroom.

Control rooms for Sound, lighting, Vision control, Production, videotape recording, and viewing galleries.

Film studios have much the same facilities of resident and non-resident workshops for all the skilled trades applicable to film making, Plasterers, carpenters, Electricians, Riggers, etc.

Special effects inlay

For both film and television you have often seen people standing in front of a beautiful scenic background when they are really standing in a studio against a plane colour background. This trick is called Chroma key for TV and travelling matt or inlay for films, the favourite colour of the special background cloth is blue or green to provide separation from the person standing in front of the background cloth, it is very important the person is not wearing the background colour, The costume department must be given advanced warning of these arrangements for continuity of the actors wardrobe. A colour separation of the subject and background may be achieved on the film being processed or electronically within the television system which makes the effect possible. If the special background cloth is unevenly illuminated this may spoil the effect by presenting ragged edges within the electronic keyed picture, and each film frame must be adjusted individually in the laboratory processing which is very time consuming.

Digital television has advantages over analogue television because it is able to separate individual pixels making special effects completely transparent (without seams or ragged edges).

Television cameras

A television camera may produce a black and white image or a colour image; the sensitivity of a modern studio camera has improved a great deal over the past 50 years. We now expect to see good quality pictures from moonlight to bright sunshine the colossal range of contrast is handled by auto iris or digital shutter speed and colour balance may be manual or automatic. This has all been achieved by the development of the CCD and CMOS imaging devices used in modern cameras, however professional broadcast cameras use three CCD devices, one for each primary colour. The light entering the camera is split into three paths Red, Green, Blue, by the use of a colour splitting prism, the three facets are coated with a colour filter to maintain spectral purity and to remove unwanted spectrum outside the perception of the human eye such as Infrared and Ultraviolet.

White is produced by the matrix combination of the three primary colours. Industrial cameras are able to see in moonlight or with infrared light at night. Examples may be seen on television of police helicopter car chases at night, an infrared camera produces the pictures.

T V studios using Modern CCD, (Charge Coupled Device) cameras Quoted Bit rates i.e. 12 bit digital = 4000:1, 10 bit 1000:1, 8 bit 256:1, the current choice is 12 bit for normal studio use which gives the camera a 4000:1 contrast range. Acting on this information the lighting contrast ratio for modern broadcast CCD cameras is somewhere between 2:1 and 100:1 for

studios, and more or less the same as film for outside locations. For vacuumed tube imaging devices a contrast ratio of 20:1 or 30:1 is about the maximum. Tube cameras are seldom used now, due to the many technical improvements to modern television cameras.

Gamma correction

Gamma correction is used to provide more details in the darker area of the camera picture as displayed on a cathode ray tube colour monitor. For digital CCD cameras a value of 0.45 gamma correction is applied, it is understood the gamma of a CRT colour monitor is 2.8. The new TFT, LCD, and plasma display colour monitors have exactly the same gamma characteristics as colour Cathode Ray tubes.

The colour temperature of studio lanterns

The general practice for TV studio lighting is to set the colour temp of all the luminaries to a value of 3100 degrees Kelvin for a supply voltage at the lamp of 230 volts (within the UK); the bulbs are supplied to give 3200 deg Kelvin at 240 volts. This is generally set by the installation electricians so the lighting console with its dimmers set at 9 on a 0 to 10 scale meet this criteria, as all the lamps are fed from dimmers this allows for adjustment of the dimmer to maintain the colour temp at the lamp by a plus or minus adjustment. The aim is to ensure that all the lamps in the studio match the desired working colour temperature at the exact same settings of the dimmers. How this is achieved is relevant to the individual studio set up. The console operator may refer to the dimmers as faders. Most systems have memories for individual lamp circuits and groups of lamps as in each set or lighting change. A studio test colour test card is often placed under a luminaire chosen as the reference light source at a specified colour temperature, all the studio colour cameras will be focused onto the same test card and the colour balance of each camera is set by the vision engineer to very exacting standards see photo below the reference key light has been dimmed well below normal colour temperature as the line-up greyscale chart shows. The camera is set at 3200K.



Television dimmer systems

Television Studios are normally fitted with dimmer systems from basic to very complicated and are installed permanently. A typical installation may have 100 times 2000 watt outlets on dimmers, 20 times 5000 watts and 10 times 10,000 watts, the AC power to the studio would be in excess of 500,000.watts (500 KW) and this would be spread over three power phases. As a lighting director you would not be expected to worry how this enormous load is balanced across the supplies, which would be the job of the chief electrician. Your plot of the positions of the luminaries would be used to provide a sensible layout of power balance and each lamp position would come to the lighting console as a number on your copy of the lighting plot. Your job is to arrange your groups of luminaries and set the heights, angles and light levels and the focus of each lamp, the spread of the light from the lamp on to the studio floor and the setting of the barn doors (Four metal flaps which are used to shade off the light from the areas you do not wish this lamp to light) this is in effect the edge of the lit area.

To even out the horizontal spread of light by the use of scrims placed in the bottom half of the face of the fresnel lens (See drawings on page 9). A scrim is a term used to describe wire gel or fibreglass material cut to fit as a half circle this has the effect of reducing the light level approximately 25% for gel and 50% for fibreglass. What you decide to use depends on the horizontal angle of the luminaire. This has been dealt with in greater detail under the title "Scrims" and "diffusers"

The studio electricians

The Chief electrician is responsible for the electrical safety and that of his crew, also the delegation to the crew for maintaining, placing, installing, operating all the lighting equipment in the assigned studios. The chief or senior electrician is the first line of command for the Lighting Film Cameraperson or lighting Director.

Working from the plot prepared by the lighting person the crew will install each luminaire complete with all accessories at each and every position shown on the lighting plot. The Chief or senior electrician along with the lighting control board operator will assign each luminaire to a circuit or dimmer number exercising extreme care that dimmers or circuits are loaded with the correct loads and that the balance of the load is spread over the three phase The numbers of each circuit will be written on the lighting plot at each lamp position shown.

When all the circuits are completed and tested the Lighting person will be invited on to the studio floor to start the ritual of setting the luminaries. The console operator will have radio talkback to the lighting person and all the electricians involved, the electricians will set the luminaries as directed, the console operator will switch on or off the circuits as requested by the Lighting person and any changes will be made as required until the setting is completed. During this process NO un-authorized persons should be present for reasons of safety. All Suspended luminaries must have "safeties" these are chains or steel wire clip loops which are provided to tie all parts of the luminaire assembly to the supporting structure

During rehearsals and takes, the console operator makes notes of all lighting cues given to him by the Lighting person and must follow these cues absolutely as directed.

Preventative maintenance must be carried out on all studio equipment at the scheduled times laid down by the chief electrician equipment failures cannot be tolerated as the lost time cost to production is very high. Standby luminaries must be complete with all ancillary parts to cover any failures during the production time.

Colour filters or gels

Colour gels fitted to luminaries provides the studio production with colour changes to backings and scenery, cyclorama, audiences, and objects. Select from a hundred and one colours available, heatproof gelatine or Acetate “Lee Filters” or “Rosco Filters”. Match your artist’s gowns with complementary colours for light entertainment. Gel frames are provided on all Fresnel luminaries, and should be kept in place in the first slot next to the lantern lens.

Health and safety

Always familiarise yourself with the health and safety rules and regulations. Never carry out work on the lighting without clearing the studio floor tell the floor manager what you have to do and he will act for you in removing the rest of the crews and artists from where you intend to work. Always inspect the area after the work is completed for any debris left behind.

Fog machines, dry ice machines

Fog is the most unpredictable substance within the studio environment always test the set up first before filming and when machines are working correctly and positions are found for best results and only then is it prudent to go for a take, you must expect several takes before getting it right. Dry Ice however is a much more controlled as the fog clouds tend to stay at floor level as cold air mostly drops down. Combinations of both fog and dry ice are often used.

Snow special effects

Polystyrene snow as a studio practical snow-fall requires a very large amount to get a convincing scene and must be attempted in one take, so allow for at least three takes! The polystyrene snow is very electrostatic and sticks to all sorts of surfaces, is one hell of a mess to clear up in the studio and should be the last scenes of the day. Back projection of snow is very useful for close ups and cut a-ways. Artificial snow machines produce real snow and may be employed for outside locations but may not be cheaper than going abroad for a real snow scene.

Rain machines

Real rain in the studio consists of horizontal pipes with fine holes drilled about every 50 mm, which are hung above the area to be used. A plastic sealed area to collect the rain fed from a water pump and reservoir, the wastewater is returned and circulated back into the reservoir. Hopefully the whole thing does not leak too much; water is to electricity like a match is to gunpowder. Safety is our first priority.

Lighting for international ice skating events

Most ice rinks have generous audience seating areas which are very steeply terraced some at 45 degrees or more so the rear seating areas are quite high above the rink, this provides good camera positions and follow spot positions. Follow spots are the best way to light the contestants and artist as they may move extremely fast and often close to the edge of the rink. For the camera to stay in focus a high light level is required from the follow spots as the cameraperson has very little chance of keeping in focus if the depth of field is too short.

Ice hockey is a very fast moving sport and cameras need good clear views of the action and this implies camera scaffold towers to gain additional height for better views of the rink. Under these conditions flood lighting the whole rink is the only way to cover ice hockey and additional audience lighting is often required, this may be suspended from the roof and or fitted to the camera scaffold towers whichever provides the best solution.

Again because the cameras are at a distance from the rink area they do need a good depth of field in order to remain in focus when covering the very fast action which automatically again implies a suitable high level of illumination.

“Holiday on Ice”

Still a current production company in Europe is a touring ice show that uses 8 or more CSI follow spots and plenty of effects lighting with fog and dry ice machines, the lighting power load falls between 25 kilowatts and 50 kilowatts depending on the contents of the show, the size of the rink and the venue.

Just a bit of history

It was 1965 when I first lit “Holiday on Ice” for an American producer, the lighting generator had to provide for 8 Super-trouper follow spots (Arcs with AC to DC converter packs) and with 200 kilowatts of AC power split between the mobile television production vehicles at 30 kilowatts and the lighting rig at 170 kilowatts, it was a very difficult rig to control as electronic dimming of lanterns was not available in a portable mode at this point in time, so all lighting changes had to be switched manually or plugs pulled to effect changes. The cameras needed a minimum of 200 ft.c of incident light to produce colour pictures and actually worked better if 250 ft.c or more was provided.

Lighting was extremely hard work and labour intensive as equipment was very heavy and very large vehicles were required to transport it, the generators were very big too providing 1000 Amps at 240 Volts this was about the largest silent generator on the road at the time.

Lighting within art galleries

When requested to illuminate oil paintings the lighting person needs to adhere to some basic rules. Old masters of great value may be easily damaged by light and heat as some pigments are light and heat sensitive. It is always best to discuss the relevant situation with the resident art expert before any decision on lighting is made.

Having found agreement to use artificial light at 3200 K, or 5400 K, the precautions to be taken are as follows, Fit the luminaries with half scrims and if possible a heat proof glass filter. Place the luminaries at a safe distance from the painting at least 3 metres from it, ensure the lamp is fully flooded and placed at 45 degrees to the horizontal and vertical with the camera square on to the picture. Adjust the position of the luminaries to remove any reflections and shine or flare into the camera viewfinder or picture monitor. If the painting has a surface texture that is raised well above the base surface try an alternative soft light. Keep the lighting level to the lowest possible value consistent with the camera focus and depth of field.

As most paintings from the masters are very old they are also very valuable and extreme care must be taken in conducting the equipment within the gallery. The use of HMI lighting is strongly recommended as opposed to QH as the HMI produces very little heat. Soft light may

be produced by pointing lots of light at the ceiling or use a sheet of polystyrene as a bounce light. Never take a break without switching the lights out and always take every opportunity to save the lights be very aware that some modern paintings may require the surface texture to be shown. Never work with the public in attendance.



The role of the designer or art director

In conceiving the idea for a program whether it is for film or television, the producer and director have a mental picture of how the production should look.

The job of the designer is to translate that mental picture into reality. In the process of translating the other person's mental image, the designer, of course, makes a few changes; he has to make the visualisation practical to build on the stage or studio floor and practical for the cameras.

This visualisation must be made artistically and visually pleasing, setting the mood and drawing the audience's attention where it is needed and finally providing an opportunity for the other craftsmen, the lighting Film Camerapersons, the costumer the make-up artist, and the scenic painters, to make their contributions effectively to the quality of the scenes.

It is quite obvious that in adjusting an idea to meet the many requirements the designer has actually substituted a whole new visual concept of his own for the original idea. What the designer really does is to devise a whole new visual concept to support the intent of the production as outlined to him by the producer, director, and the script, that is his real job.

The visual concept must provide strength and excitement, if these two elements are lacking the designer has failed. If the visual elements of strength and excitement are too strong and they dominate the program, the designer has failed again.

The role of the designer is a demanding one and it requires a strong personality to command it. Creative talent, imagination, and technical knowledge are vital, so also is the ability to understand and deal with many people, to anticipate and follow their thinking.

The successful designer is one with flair and style that sets him apart from the plodder. He must be strong enough to resist directional ideas that are not visually correct, and have imagination for other ideas. Very often a producer or director may not really know the visual concept they want and talk of many things in the hope of provoking the designer into suggesting a visual concept. Working out this visual may take many sketches, many discussions until agreement is reached, the result may be very different from the original concept.

He must research architecture, customs, décor, and fashions, to assure artistic authenticity in his designs.

He must understand the intent, the mood, of the production, and create perspective through tone and architectural form.

He must understand how a camera sees things, the lens angles, an idea of distance and space required by the cameras and the sound pick-up booms.

He must understand the requirements of all the other contributors to the production and be a good business manager working within the budget at his disposal.

The property man

The Prop man provides furniture, fittings, place settings, bric-a-brac, and dressings as requested by the Designer.

The carpenters

In the construction workshop Carpenters build the sets and anything else required by the production designer, they will make anything required by the production including large wooden gel frames for lighting.

The stagehands

They erect the sets and attend to any changes required and they give an all around service to the production.

Plaster work

Plaster work is often required for set interiors and Film studios have workshops to make the plaster castings. Very elaborate decorations are produced with great skill and modern materials are often used along with plaster finishes.

The graphics designer

The graphic designer designs and prepares slides, signs, maps, cards, backgrounds, models and computer graphics. This role has taken on new and vast concepts within the television and film industry and in some cases the scenes are totally computer graphics with the players (Artistes) inlaid to match the action.

Continuity

The continuity person must work with every one, the job is to make sure location shoots are consistent in continuity with the studio and small details are maintained throughout the production and that scenes match from day to day in costume, make-up, set dressings, hair style, props, etc. Each department must be awake to these problems of continuity.

Make-up

My approach to make-up is very positive. Make-up will always be needed and contributes to lighting in a big way. Special effects make-up is an art form and requires a great deal of skill. The every day need whilst filming or televising is to maintain continuity and excellent consistent facial tones, this requires a constant awareness of each artiste, heat in the studio causes sweating and subsequent shine on foreheads and is attended to by make-up during the production. Continuity is always to the forefront of every shoot day. Colours of lipsticks

are very important and must be chosen with great care for monochrome and colour film or television. Masking undesirable features has always been a job for make-up. Most children look best without make-up.

Hairdressers are very important to each artiste, they must keep the styles consistent and tidy and in keeping with the period for each and every day the artistes are on set.

This is not an easy task as it may be very intrusive on the time allotted for the artists call times and the continuity of the production. Early calls are very unpopular but often unavoidable.

The costume designer

The Costume designer looks after all the fabrics and costumes that appear in the production to ensure they are acceptable by the technical limitations of the systems and are in keeping with the period and fashion of the production.

Pure white and black material for costumes should be avoided if possible as these cause inherent contrast problems for lighting. Polished armour can be a pig to deal with, as they tend to reflect all the lights. Only dulling the shine will eradicate these reflections. Jewellery worn by the artists must be camera tested and vetted by the sound supervising engineer for any annoying rattles.

Film studios

Film studios do not always provide luminaries as part of the studio hire these must be obtained separately, "Lighting Boats" are provided but have to be positioned before the scenery or sets are built on the studio floor, the lighting boats are very large platforms with hand rails, they are suspended from the roof of the studio and are connected by gangplanks for the electricians to attend to the luminaries positioned on them. Pre-knowledge of the set construction and drawings must be utilised to position the lighting boats from which the luminaries are placed according to the lighting plot for the film production. This all takes a long time to organise and would only be undertaken by a Senior Lighting Camera person within the Film Industry who would be advised by the associated scenic designer.

It takes a lot of training and experience to get this far in the film world. When you consider that film budgets run into millions of dollars the responsibility is considerable for the senior lighting cameraperson there is no room for errors.

Outside locations or remotes

The Lighting Film Cameraperson or Lighting Director / Engineering manager in the company of the Production Director and the Chief electrician should visit the location at least a week or more, in advance to survey the lighting and production requirements Permissions must be obtained well in advance for any location shoot. The chief electrician must speak to local authorities and site owners to find enough power for the lighting and also for the units on site, or arrange for generators with suitable parking away from the action. Scaffolding may be required for hanging luminaries or mounting camera positions. The chief electrician will be responsible for matching his crew schedule, and hire of any lighting equipment, the collection and return of hired equipment and a confirmed total price for the job.

He must keep proper and correct records of any overtime payments or additional costs over and above the quote, and provide the production the accountants all the paperwork. Local authority regulations for safety of the public must be adhered to and may be supervised by a government official.

After the installation of the lighting equipment the focusing and setting operations are much the same as in the studio. Special time must be given within the schedule to build and set the scenes and allow for the lighting rig and setting. Remotes like these often use much bigger luminaries to cope with daylight. Thus Arc lamps or HMI would be chosen along with many other types of luminaries. For television the overall costs for the outside broadcast or recording would be controlled by the Lighting director / Engineering manager who in turn would be working to a strict budget.

Fashion show outside location

The lighting plot for a fashion show is basic and simple and takes place inside a tent like structure made from scaffold tubes, rain proof and light proof it is very similar to one which is used outside the science museum in London each fashion year and shown on London News Network fashion week. The design for the interior changes each year but the construction remains much the same. The ceiling height is about 14-16 feet and lanterns are suspended from the scaffold structure.

Behind the screens in the dressing area interviews are conducted with portable equipment ENG cameras with hand held or camera bashers, stands get in the way as the area is so busy with beauty make-up dressers and dressers rails, and lots of VIP's.

The luxury of having camera platforms is very much desired due to the abundance of press photographers milling around the catwalk assigned areas the camera person on the hand-held has to have a rigger person to defend his view in order to get his pictures without the press jumping in front of camera.

These platforms provide freedom from the press jostling and provide better and clearer views for the main events on the catwalk.

Lighting is there for these angles to be seen by the two rostrum cameras if a television lighting camera person is allowed to light it, but often this is done by a show lighting company and would be only for the audience to see the models in the fashion sense for each designer plenty of white light for the models on the cat walk and lots of effects lights such as the SHOWTEC or MAC 500 moving head lighting effects.

The lighting should be flattering to the models so I have included a selection of left and right key-lights with Patten dressing lights on the entrance backing and backlights which act as key lights as the models return to the dressing room. Bottom half and diagonal scrims must be used to even out the light over the walking distances.

Twirls and stances by the models occur on the circular rostrum and this is mainly covered by the photographers seated or standing around it. Flash photo sessions produce flicker effects on the television cameras.

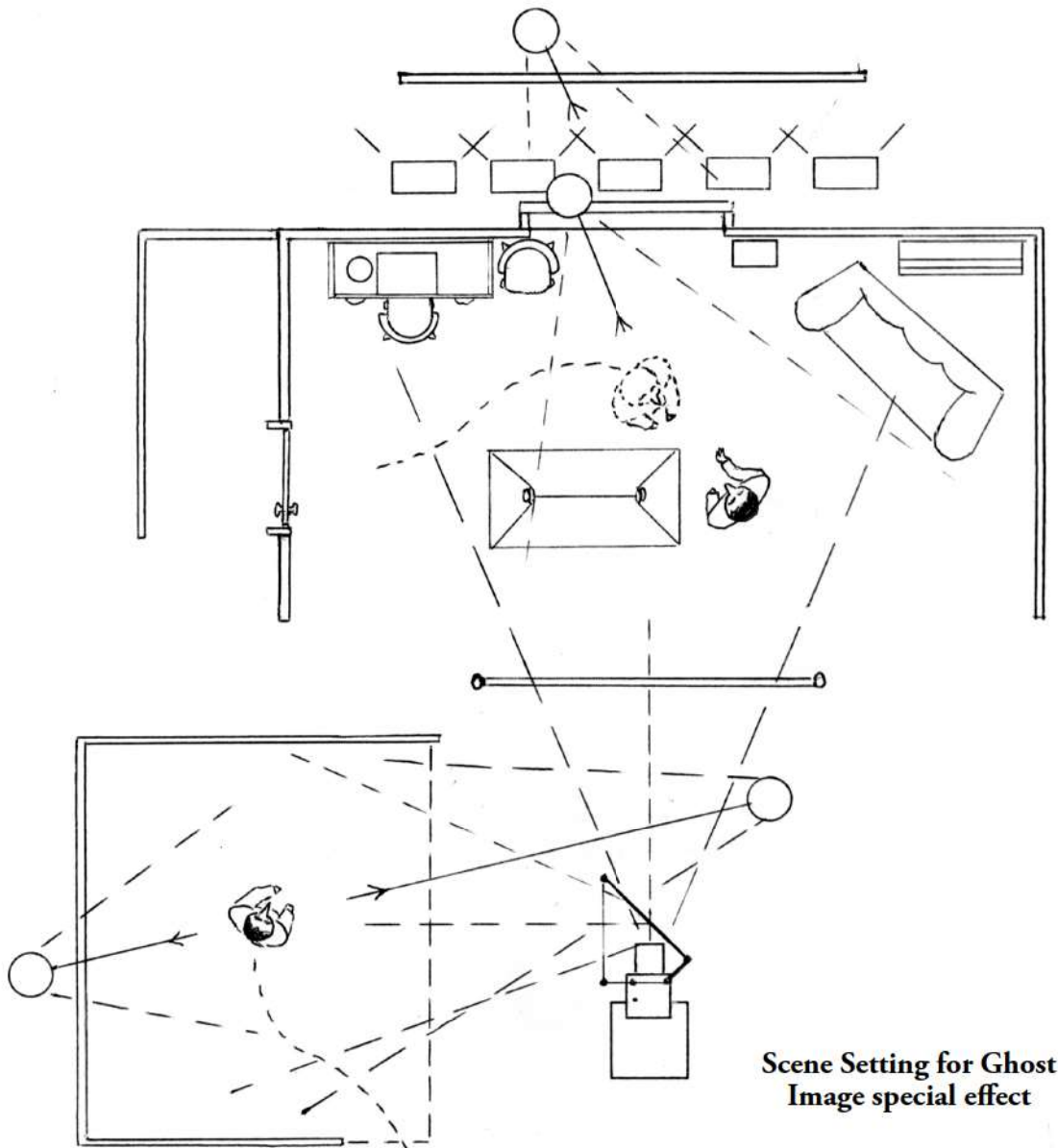

Ghost scene

The camera views the combined image of the ghost and the player, the camera lens is 45 degrees wide, the height is fixed at 5 ft 6 inches, and in front of the lens is a panel of glass fixed at 45 degrees in which the ghost image is to be seen on the immediate left at 90 degrees to the camera lens, When the lighting level is raised on the set to the left of camera, the ghost image appears as a mirror image and when the light is lowered the image disappears. A black flag or gobo is placed over and above the lens to mask off lights from the top of the main setting in front of the camera and removes any stray light. The side set is made of black velvet drapes and care must be taken to avoid lighting these drapes. On the main set facing the camera two I K lanterns provide backlight through the window and over the top of the rear of the set, the low key outside scene through the window is lit with various blue gels, in the centre of the room a coffin light is used to illuminate most of the room with a very low level of soft light. Positioning is quite critical for both of the players within each setting. It is very important the distance from the front of lens to both the actors is the same for the ghost and the main set actor's position, in order to maintain the correct proportions of each actor thus maintaining continuity.

Technical tools

Video assist

This is a system that provides high quality colour television pictures and a sound system with the film cameras in use on the motion picture. The camera is provided with a splitter prism, which is fitted with a CCD colour camera providing a viewfinder picture for all to see. The system provides the ability to record a Hard disk copy of each take that is made by the film camera. Mix and overlay, plus record and playback facilities are provided. Individual prints are available of any frame of the film as recorded on Hard disk or by the use of computer digital storage medium and may also provide monochrome or colour printouts.

Addavision

Please note that in 1968 “Intertel” was the first company in Europe to introduce a method of making feature films for the cinema and television distribution, called “Addavision” either from their studios or any outside locations using a mobile control room.

A system utilizing a vidicon monochrome camera attached to a Mitchell 35 mm, motion film camera by the use of an optical splitter. The picture from each camera could be seen on a monitor and the cameraperson could rehearse the scenes until the Director was satisfied with the rehearsal and ready to roll the film cameras for the final transmission take, this avoided wasting time and film stock. The vision operator engineer controlled the exposure of the film cameras by remote iris control. Multi camera action could be achieved all in one take using three cameras within the same scene.

The Director of the film could see all three pictures and he could vision mix the video to produce a completed post-edited version of the film on videotape. The resulting film takes were identical to the video recording and could be shown as a rough edited copy to the artiste’s the same evening of each days shoot, this way it was possible to get a studio film production of one and a half hours completed within a few weeks!

The quality and gradation or “timing” of the film processing was very close to perfection, the editor was able to cut together a perfect copy of what the director required. This was a quality product ideal for making and distributing worldwide television serials and dramas.

For television serials and drama productions film has always been the best medium for world distribution to all television stations. These days the situation has changed in favour of Digital copy on tape or disk.

Camera filters for film use

Always consult your film camera hire company, as there are so many different types of filters available. Note the three most important filters, Ultraviolet, Neutral density, and colour correction for daylight and tungsten film. Please refer to the Kodak "Wratten" filters Data booklet, or the LEE Filters handbook, the subject is too extensive to include here.

Colour gelatines acetates and filters

With out-side location filming the relationship of windows and inside practical lights as seen from the inside and outside requires careful thought. If you are to film in daylight on the outside of a house looking into a room through a window, the inside of the room may be lit with daylight colour temperature lights if the shots from the camera on the outside are to match the camera shots inside the room. This would admittedly be a strange situation but is valid for some situations. The alternative situation would be lighting the inside with daylight colour temperature lights to match the scenes through the windows from the interior. At this point we must stop and consider alternatives as the visual results of either of the above approaches may not be visually acceptable on screen, consider the scene inside the room;- we expect to see a colder light outside compared to the practical lights used to light the room. If we have to look into the room from outside we would expect to see a cosy warm room.

The conclusion to the dilemma is the use of Gelatine filters to make subtle changes for the interior and exterior shots. Unlike television the filming is not continuous so we are able to light and set each shot as an individual situation. First consider that the home base studio lighting is 3200 K, and matching interiors between studio set-ups and outside location interiors is required for this picture, then it stands to reason that the location interiors will be 3200 K, the windows will need Full C T Orange gelatines to reduce the blue daylight to a more acceptable colour for the interior scenes, likewise for the camera shots looking into the room from outside these window gels would need to be changed to provide the reverse effect and a full C T Blue gelatine would be used on the inside of the window, as this outside camera will have a daylight filter fitted to correct daylight to tungsten film stock, removing the filter from the camera does not solve this problem as we are seeing the outside in daylight as well.

The outside camera will look into the room and should see exactly the same 3200 K lighting in the room. Without the interior window blue gel, the interior lighting would be very red and would not match anything else.

Another situation that must be considered is when we have people walking into, and out of, an interior scene to external day light, in this case there is one answer, light the interior for daylight. All practical lights would have their bulbs changed for daylight bulbs or fitted with C T blue gels. This situation is often presented to the film lighting cameraperson and should always be discussed with the director in great detail in order to make decisions on how best to accomplish the practical aspects of the artiste walking in and out and keeping a colour balance. Another answer is to build a tent of gelatine around the outside doorway in order to keep the interior colour balance at 3200 K and make a cut away to change from tungsten light to daylight.

For all interior scenes all practical lights should be on dimmers or rheostats in order to have control of the colour temperature, and windows need to be gel covered all over to lower the outside daylight colour temperature to near that of the interior but still retaining daylight feel to the scene. Make notes of the gels being used and note the C Temp readings from the various sources of light, these details are essential for matching colours in other scenes between location and studio filming. When lanterns cannot be dimmed electrically, wire

scrims are used to reduce levels and a pale gold (54 gel) in the key lights will warm the faces to match the practical lights.

Fluorescent lights and filters

If these are essential as part of a scene the colour needs to be corrected by wrapping “Minus green” Rosco or Lee gels around the tubes, this will make them appear purple and if you are in doubt about this take a Polaroid photo just to be sure. You could put a minus green filter on your camera lenses but this creates another problem, the additional lighting you may wish to add to the scene will NOT match the colour spectrum of the fluorescent lighting, unless these are also corrected. One problem creates another, which is the best answer is really a matter of how many fluorescents have to be corrected with minus green gels, and how many additional lanterns are to be added. If you are working in a very modern building with hundreds of fluorescent fittings then it is not practical to filter the fittings but to use a camera lens filter instead.

Lee filters have a complete range of filters to correct any fluorescent lights. Kodak publications produce lists of recommended camera correction filters.

To avoid a contrasty print when filming under fluorescent lighting use a Tiffen L C 3 filter on the camera.

For neutral density filters I would recommend “Pancro mirrors” as there is absolutely no colour bias at any density.

The Grad filter (graduated from top to bottom, side to side etc) is used to darken areas that are too bright such as a sky or horizon, or sun lit white wall to one side of shot.

ND and Colour versions are available. Polarised filters are used to lighten or darken an area such as the sky and have many other applications. Grad and Polarised filters are recommended for static shots only.

Fog filters, Star filters, Frost filters, Black ladies stockings various textures, Black dot texture screens, and Optical glass smeared with Vaseline.

Whenever filters are used it is prudent to carry out film tests, note that filters have different effects at different focal lengths.

Illusions or camera tricks

To obtain a very wide shot of a studio setting, when this would include all the lighting in the roof of the studio in order to get the whole width of the set in shot. A clever solution is to lock off the wide shot camera and place a glass in front of the lens so that a scenic artiste may paint the rest of the roof outlines and sky on the glass. This is a very neat camera trick to provide a sky in place of the hanging studio lighting and roof. With the use of video assist the scenic artist is able to see a video picture from the camera on a large flat screen monitor and paint a very accurate extension to the setting thus producing a very fine wide shot to be filmed or recorded.

This method of providing a wide shot does have its pitfalls the camera must not move until the recording or filming is completed to every ones satisfaction of this shot and it should only be attempted on a fixed lens because a zoom lens might creep by itself and spoil the shot.

Lighting the glass picture must be done at the same colour temperature as the lighting on the set, reflections should not be seen in the glass on the camera side of the glass so black drapes are used to hide these and the camera.

Control of individual lights in the studio

It depends upon the studio and the systems installed. Film studios may not have any control systems; they would be hired if needed. Because motion picture filming is done in "TAKES" the lighting tends to be set up for each individual take, luminaries are placed to make maximum use of modelling for the artist's and the settings. Dimmers may be used for effects and dressing lights but main key lights would be set and placed to provide the light levels required by the film camera lenses. The "F" stop and film speed fixes the level or amount of light to be used; the colour temperature of the light is very carefully controlled with the use of a colour meter. Colour gels are used to portray sunshine through a window or an out door scene (inside the studio) and night time is portrayed by blue gels on the luminaries to light the settings and also the artists. In the early days of film lighting, cameramen used filters on the camera lens to portray night scenes when shooting their film in daylight. These days a more professional approach is taken, by doing the night scenes for real with lots of luminaries to dress up the outside areas. During filming of the various scenes a series of close ups from differing angles may be filmed these provide editorial "cut a ways" to fill in any gaps between master studio sequences. It is quite common to shoot completely out of sequence parts of the production filming; second unit filming could be half way around the world. This brings us to film stock, the same film stock must be used to complete all filming and ensure that colour matching is precise and the film speed is consistent. The processing must be of the highest standard for the master edited copy, from which copy prints are made for world distribution.

The providers of the film stock must be told by the film lighting cameraperson what ratio does he estimate for "Takes" and how much stock should be produced or is needed for the production.

Test film is provided to check out the camera equipment to make sure all the lenses are working and have no defects such as spiders on the inside surfaces of the lens elements and dampness inside the lens especially long focus lenses telephoto lenses. Also colour rendition of the lenses, and the mechanical performance of the lenses. The film cameras must be in perfect working order. Auditions may be required and this provides a good opportunity to check out the equipment and film stock.

Film contrast and colour

Film is capable of large contrast ratios, but this depends on the type of film stock selected for use and how it is exposed to light, and how it is processed in the film development laboratories.

Film is designed to respond to that part of the spectrum that is seen by the human eye and provides a distinctive and accurate colour rendering of the scene.

Film cannot be used at night without special lighting this applies to movies not stills.

To use film at night in all but total darkness one must normally use the electronic image intensifier but these devices restrict the image to monochrome or green pictures. Extremely fast film stock is available rated at 1800 ASA to be used with caution.

For both mediums film and television the same lighting equipment is commonly used, there are some major differences with very high-powered lights used more often for films than in television. It depends on the location and individual requirements as to the selection of the lighting equipment.

In all of the above requirements you need to have a fundamental knowledge of film processing to be able to manipulate the results to your own advantage.

Lightflex

A sophisticated system of image enhancement for film exposure, the unit is fitted in front of the film camera lens in place of the matt box. The Lightflex reflects diffuse soft light into the camera lens and onto the film; the light reduces the contrast and increases the details in the black areas or shadow areas. (This works the same way as bias light in the television camera tubes once used) It expands the contrast range of the film stock. White light 5400 K, or tungsten at 3200 K and all colours may be used. These filters are provided in filter packs.

A very useful tool to the film lighting cameraperson, Lightflex reduces the need for fill light, and in some situations no fill light would be used at all.

The results are similar to “Post Flashing” the re exposure of the exposed film to a weak light source done in the film processing Labs which results in the blacks becoming more grey and reducing the contrast range of the scene. A great deal may said about Lightflex but do get a copy of the brochure and read it for your self.

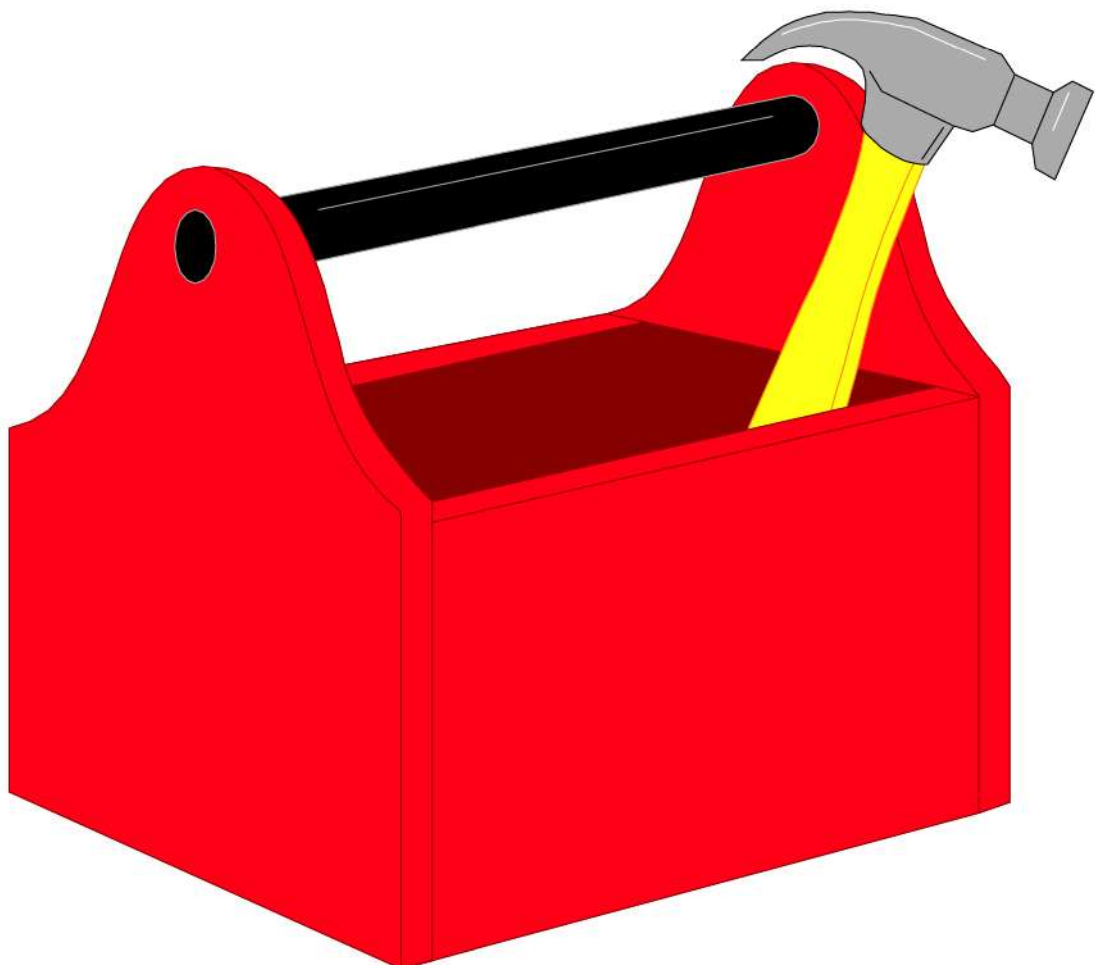



Laboratory printing

It pays dividends to visit a film-processing laboratory such as Kodak just to see how much manipulation the film may be given by the developing and printing process. In the U S A this is called "Timing" we call it "Grading" this is an art form on its own and with the help of the Timer or Grader person a whole lot of wonderful things may be done with the exposed film and the subsequent prints.

Screening with the Grader or Timer .The film lighting camera person must attend the printing lab for the shot selection process in order to match precisely each and every shot to your satisfaction, this will take many weeks of work. You are responsible for your film printing and no one else! So when you are making a motion picture always try to keep the exposure at the correct ratings or exposure index figure for the film stock in use, for this will provide the most flexibility in the Timing or Grading process. Under exposure causes milky blacks and lowers the contrast as the negative has to be printed UP, over exposure produces rich blacks and increases the contrast and would need to be printed DOWN. Either does not allow much latitude for changes in the processing.

Film transfers to other mediums

The Rank Cintel Flying Spot Scanner used to transfer feature films and commercials to all Television formats, also Laser Transfers used to convert film to television or television to film. Modern day electronics has provided some very exciting methods of transferring film to video formats, which provide the Film Lighting cameraperson the flexibility to grade the film for transfer and by the ability of the machine to store every frame of the film in digital pixel form. This provides adjustments of colour and contrast of every frame within the film that is memorised for the final transfer. On top of this is the ability to edit sequences by the manipulation of whole sequences into a picture store (multi hard disk computer type store) and recalling and inserting at different places. Further by the use of computer imaging whole new images may be placed into the film as mixes and inlays such as Ghost images or cartoon characters.

A D R (Analogue to Digital Recording)

Not to be confused with Automatic dialog replacement.

A technology for the conversion of audio and film images to digital formats such as DVD (Digital Versatile Disk) after the film has been processed, graded (timed), and edited for the cinema. Further editing and mixing may be carried out for the DVD release, such as the additional footage showing the making of the film with promotions and various takes not directly used in the movie such as trailers and advertisements.

Sound is already recorded onto a digital format at location and pre-recorded material inserted for mixing and playbacks on the Lot/studio.

Aspect ratios past and present

Vintage television, historically in the early television receivers, the display cathode ray tube was circular and presenting a picture to fit within the circle would have optimised the picture as a square. At the time it was felt by photographers that this was not a good format and a more realistic frame size was the 35mm format as this was more pleasing to the eye, at this historic time of the decision to transmit monochrome television pictures in a new system for public viewing the decision had to be made on the format.

Film projection however had established 8mm, 16mm, and 35mm formats long before the 405 line television system was invented, the 35 mm frame size was well established and this was a good reason to use this as the foundation format for use in television broadcasting.

The aspect ratio for television broadcasting was set to 4 by 3, in the ratio of four horizontal by three vertical and to match the technical requirements for a system of interlaced picture frames consisting of 405 lines horizontal at a vertical rate of 50 interlaced frames, 25 odd and 25 even frames, to produce 25 complete frames or complete interlaced pictures per second, This system was also based on the need to lock the 50 frames per second with the 50 cycles per second AC electricity supply, thus synchronising the two systems, this was to remove any lighting flicker effects that would have been seen on the display tube screen.

Unfortunately for television the film industry standard of projecting film at the rate of 24 complete pictures or frames per second is at odds with the frame speed of television. The film projection rate for television had to be changed to 25 frames per second in order to avoid the unpleasant flicker effect.

This also meant that films shown on the television system would run faster and finish in less time than in the cinema. This small time difference was readily acceptable to the viewer and also the film industry.

Moving on to the present days we now have many more forms of visual systems and aspect ratios for television and film, Anamorphic lenses for film cameras and matching projection systems for super wide cinema screens, 16 by 9 High definition television recordings, transmission and projection, the aspect ratios available today may be changed by tomorrow in the rapid progress of the electronic visual world. Analogue television is to be replaced completely by digital and we must expect to see the demise of film as a photo print medium to be replaced by digital formats which will no doubt have many different aspect ratios available and to choose from.

Feature films shot on film cameras will eventually be surpassed and replaced by the digital environment and the film cameras placed in the museums, Very High Definition Giga pixel digital all electronic motion picture cameras fitted with T F T or equivalent electronic high definition colour viewfinders will emerge and these new cameras will surpass anything the existing motion picture film cameras could ever offer.

Good lenses are getting better and they will always remain supreme against any digital zooms. No more processing of film to delay the shoot days, Instant playbacks of the real takes each day, direct inject of digital effects and instant digital processing with manipulation of the images. Editing done onsite to show the results of the recorded material for each days shoot. To have instant digital recording and playback facilities, providing confirmation and back up

with hard copy on multiple disk systems. This will be the way forward for the feature movie industry and this process has already begun.

Special equipment used in film and television

Cranes industrial and specialised, cherry pickers up to 240 feet high these may be used for camera platforms or lighting rigs such as the flying moon. Currently there are more than 50 different dolly's or cranes in use within the film and television industry

- "Coral" a remote or riding mode crane, remote means the camera is remotely controlled.
- "Adder" one of the longest remote control crane arms.
- "Boomslang" a very stable riding crane, riding means the operators ride on the crane.
- "Chapman" a hybrid dolly with tracking wheels or rubber tyres.
- "Chapman" Super Pee Wee.

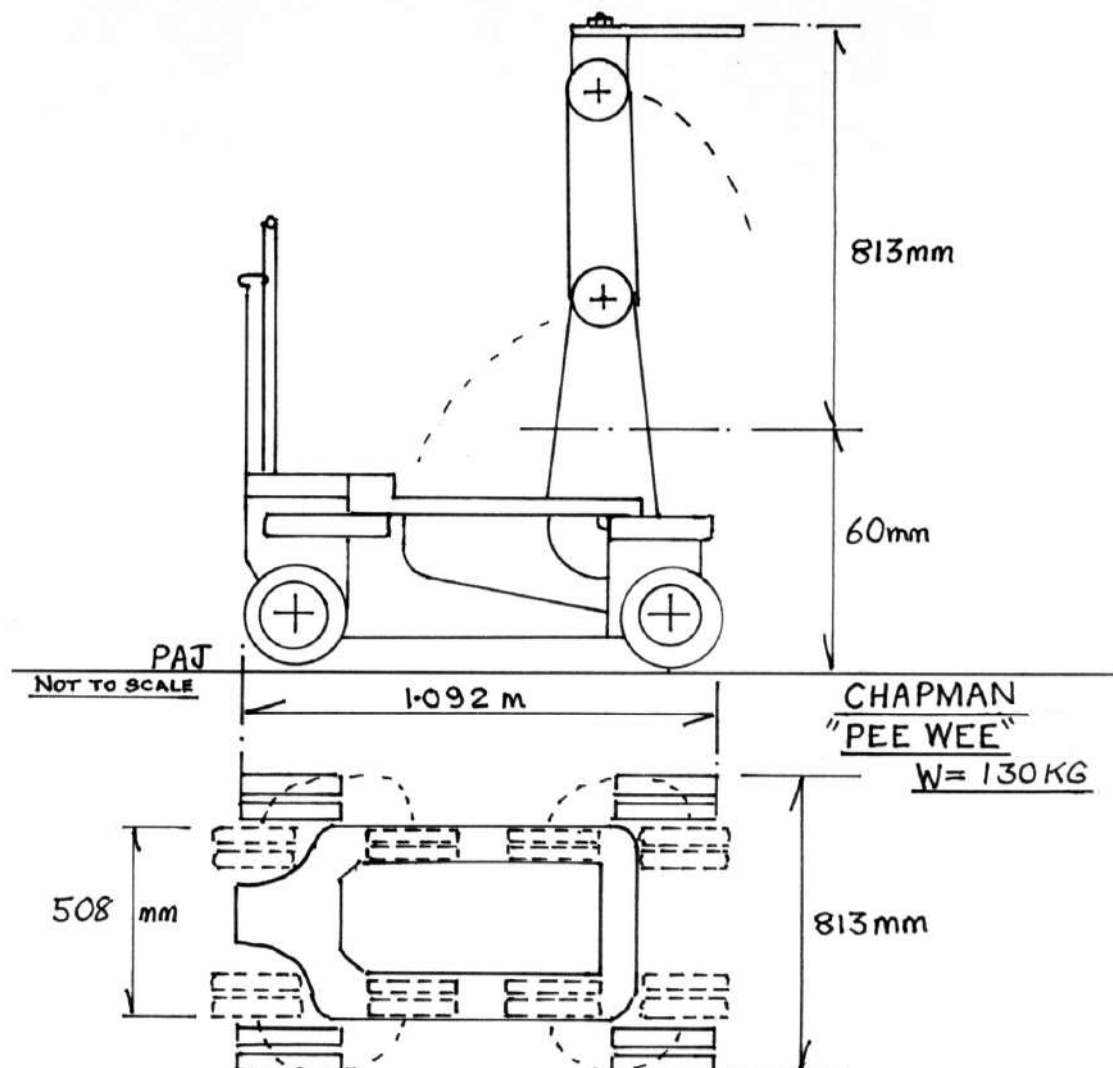

- “Fraser” a camera dolly.
- “Jimmy Jib” a remote long arm crane which is very popular in television studios.
- “Stedycam” a body mount for walking or running which is used for film and television, the action or view is from just above ground level to above head height. The system supports electronic view finder which is made to provide a picture in daylight conditions for both film and television as a display screen for the operator. This person needs to be very strong and fit as the equipment is quite heavy.

The Pee Wee designed by Ralf Chapman’s son Leonard Chapman, he received an Oscar for this design one of the smallest camera dolly’s within the Chapman range. The camera arm folds down into the frame and provides a very small compact dolly on wheels or rails it has a very small turning circle. The operator stands to the side or rear as there is no room for a seat. This is not strictly a crane but it does have the ability to reach over an object.

The studio and outside location use of remote crane arms is now much the standard procedure for both film and television as it possible to control all aspects of both film and television cameras remotely. Focus, zoom, pan, tilt, positions of the camera, roll film, stop, pause, and view the image with a viewfinder at the operator’s studio floor position. Providing a much longer reach to ceiling height, more than conventional cranes which carry the operators on the camera platform. Joystick control of the cameras position and crane arm are now possible for smooth camera action.

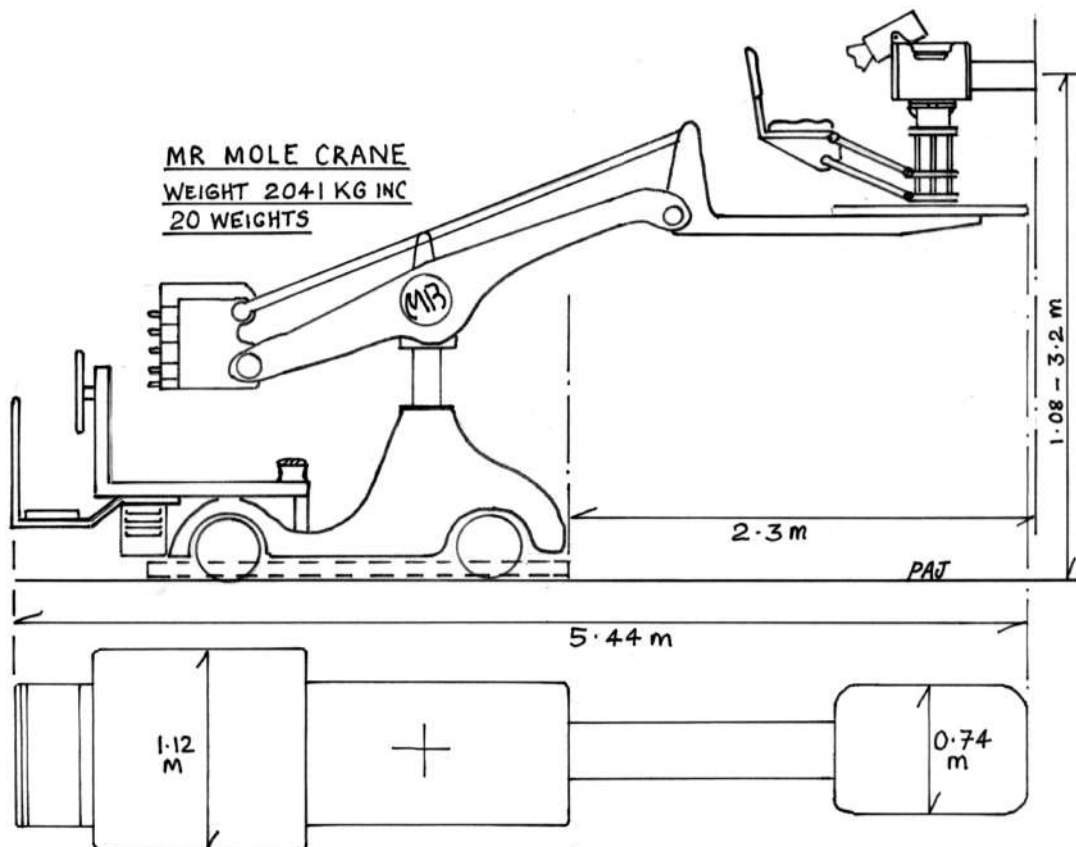

The Kestrel

Designed for outside broadcast television work, pneumatic or solid tyres may be fitted. The crane arm is hydraulically balanced. The control of jib height is at the rear or from the camera operator's position. The front wheels may be retracted to reduce the width but the stability is poor. Solid tyres are fitted when used in the television studio as the floor is absolutely flat and smooth. There is no over reach with the jib arm. To put it bluntly it is a very basic and simple tracking dolly which had to stand up to hard use and bad weather it was tough and required very little maintenance.

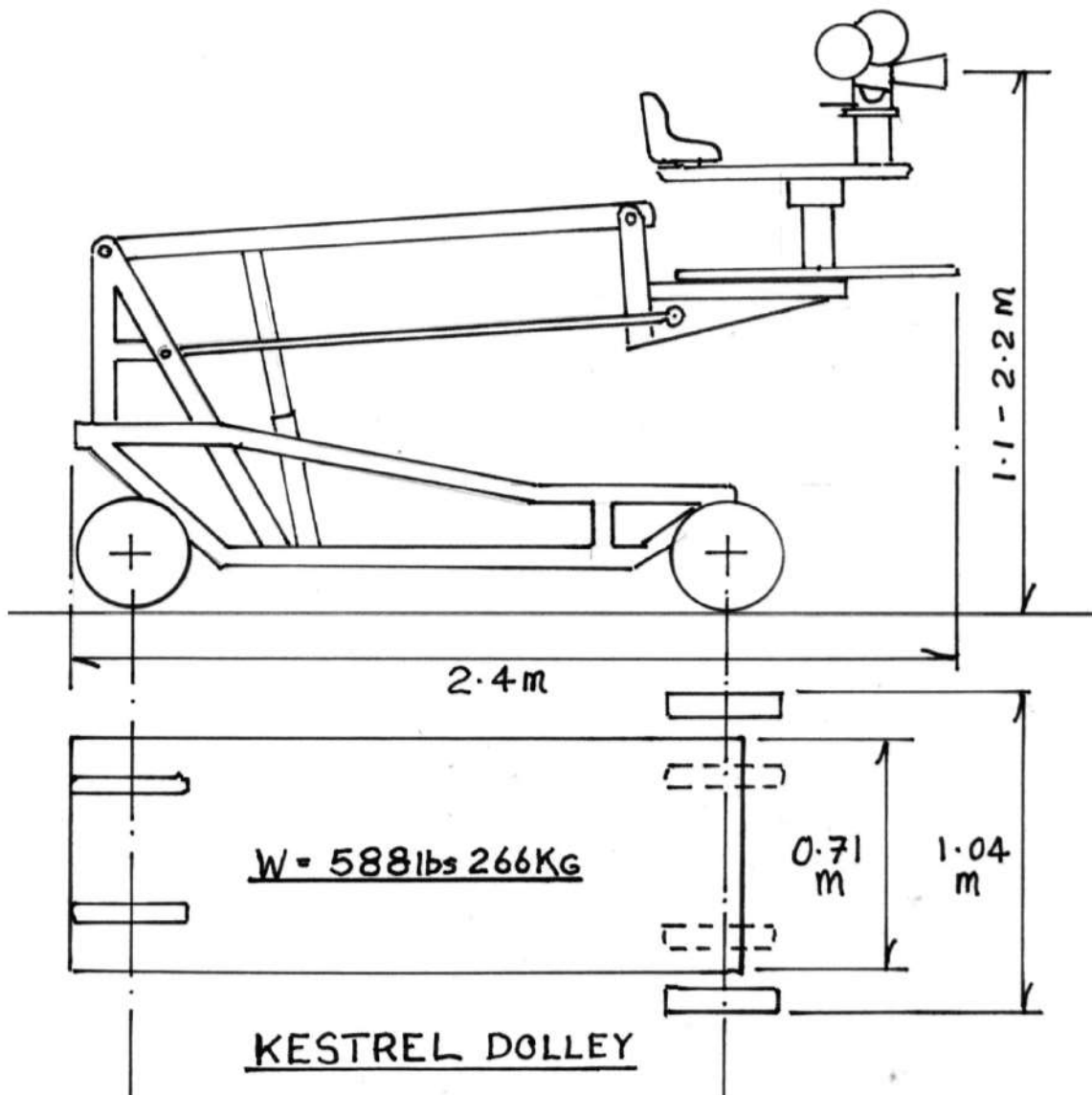

The Mole Richardson camera crane a classic of the past has been used in the film and television industry for many years. It was designed to run on 110 volts DC in its original form, the crane was adapted for use in television studios and was fitted with an AC inverter to provide the DC it required for the driving motor, when not in use the crane had to be lifted off the floor to avoid causing flat surfaces on the solid rubber tyres due to its extreme weight, sadly the crane is now mostly obsolete.

Simon Crane used for outside filming and television events, such as the open golf championships, tennis, motor racing, horse racing, and many other open-air events.

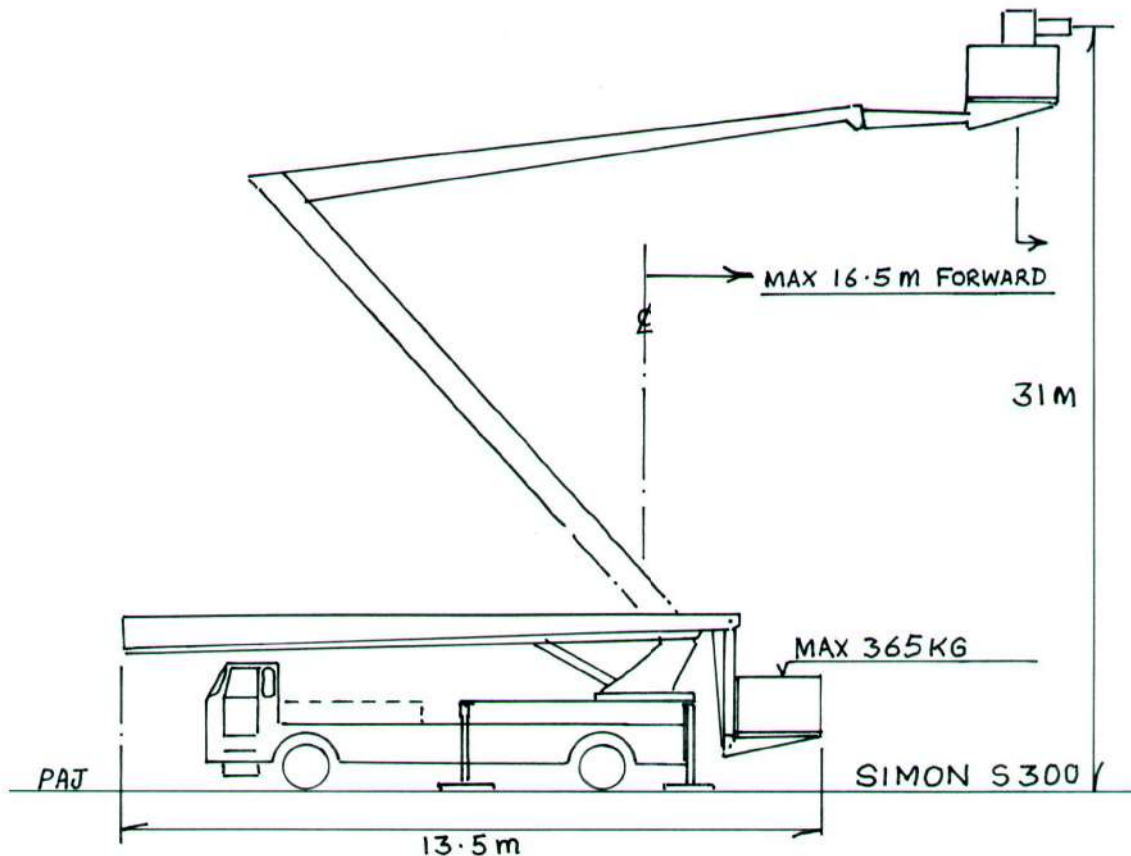

The three-part boom construction provides the facility to reach over and down an obstruction. Various platforms of different size are available to attach to the top boom.

Special motorbike mounts are available for television cameras with radio links.

Tracking vehicles of various formats with specialised camera mounts are all available from many different hire companies. Filming through the windows of a vehicle placed on a platform trailer, thus providing safe moving shots on the highways the actors are not actually driving the vehicle but only going through the motions.

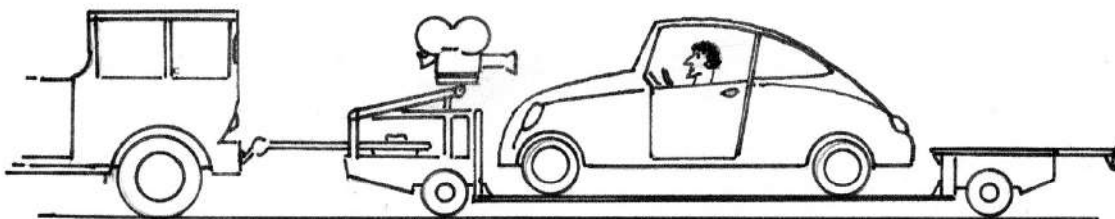

Film or video cameras may be used on these trailers with the operators travelling on the moving platform; remote controls may also be used and operated from the towing vehicle, portable lighting may be attached to many places and run from onboard batteries or a small generator in the towing vehicle. Multiple camera positions may be arranged on the trailers.

Appendix on colour temperature and units of measurement

An excerpt from “Elements of colour in Professional Motion Pictures” prepared by the society of Motion Pictures and Television Engineers.

Colour temperature refers to the colour of a theoretically perfect source of radiant energy, which emits light because of its very high temperature. Such a perfect thermal radiator – called “perfect” because it emits the maximum possible amount of light for any given source temperature – is known as a “Blackbody” * radiator. The light it emits depends on its temperature. The higher the colour temperature the light gets bluer, the lower the colour temperature, the light becomes redder. Now the colour of light emitted by most thermal radiators (or even by many sources of light which are not light, as we shall see) can be matched visually by light from a blackbody at some temperature, and the temperature to which a blackbody must be heated in order to emit light of the same visual colour quality is said to be the colour temperature of the source in question.

This temperature is expressed in degrees Kelvin (K), obtained by adding 273 to the temperature in centigrade. Thus, when a light source matches visually the colour of a blackbody radiator, it is said to have a colour temperature equal to the actual temperature of the blackbody in degrees Kelvin.

A simple example may help to clarify this concept of colour temperature. Suppose we heat an iron poker in an extremely hot flame, using an oxyacetylene torch. Iron is not a perfect blackbody radiator; however, assume it is as we hold the poker in the flame the iron gets extremely hot and soon it starts to glow a dark red it is now “Red Hot” and its colour temperature is about 1000 degrees Kelvin (K). And since we are assuming it to be a blackbody, its colour temp is also 1000 degrees K. Now any light source, regardless of its actual temperature, which gives off light of this particular red colour would be said to have a colour temperature of 1000 degrees K.

Suppose we continued to heat the poker, it would get hotter and its colour would change from red to orange to bright yellow. At about 3200 degrees K it would be a yellowish white colour, close to the colour of a tungsten filament light bulb. A tungsten lamp, therefore, which emits light of this same colour, has a colour temperature of 3200 degrees K. Now consider a firefly its colour temperature is 5000 degrees K. But the firefly is cold!

If our poker was to be heated to 10,000 degrees we would find it was “blue hot” The blue sky has a colour temp of 10,000 degrees K or more if you go higher up a mountain. Yet its actual temperature is below freezing. We know that the blue colour of the sky is due to scattering of the blue wavelengths of sunlight. This colour is the same colour as a blackbody heated to the real temperature of 10,000 degrees K.

We noted that our iron poker was not really a blackbody; we only assumed it to be one in order to clarify the concept of colour temperature. As a matter of fact, no practical light source is a perfect or blackbody radiator, although some sources such as the sun and a tungsten filament are fairly close approximations. For this reason a source such as a tungsten filament is sometimes called a “grey body” source or a grey emitter.

An important characteristic of a blackbody or a grey-body light source, and one that is particularly important for colour photography is that the relative amount of radiant energy emitted changes gradually from wavelength to wavelength. Such a source is said to have a smoothly varying spectral emission curve. The sun and a tungsten filament are sources of this type, whereas a fluorescent lamp shows large and erratic fluctuations in light output from wavelength to wavelength. A mixture of two or more light sources of different colour temperature, which are essentially grey-bodies, may also result in an emission curve for the mixture, which departs considerably from the spectral energy distribution of a grey-body source. A mixture of sunlight and skylight sometimes behaves in this fashion.

A light source that does not have a smoothly varying emission curve is not only undesirable for colour photography, but it is also deceptive if we try to evaluate its spectral energy distribution (the amount of light output at each wavelength) by determining its colour temperature. Remembering that the colour temperature of a light source refers to the actual temperature of a blackbody source, which is a visual colour match for the source in question, this is not too difficult to understand. The concept of colour temp relates light sources, which look alike to the eye. Knowing as we do the ability of the eye to adapt, it becomes easy for us to realize that the light source which has peaks and valleys in its spectral emission curve (and thus may be almost lacking in radiant energy at some wavelengths) may appear to be a colour match for a source such as a tungsten lamp, which has a smoothly varying Emission curve.

Both sources might have a colour temp of, 3000 degrees K; yet while they look alike to the eye, some objects illuminated by them might photograph quite differently.

The studio working house lights, which are normally, fluorescents are a prime example, compare two television camera pictures, when one is looking at a colour chart under fluorescent light and the other camera looking at an identical colour chart under a tungsten light, the difference between the charts is quite obvious.

A beautiful black body

It might be of interest to note why a “perfect” radiator should be known as a “blackbody”. When radiation falls on an opaque body, part of that radiation is reflected and part of it is absorbed. Of course, the blacker the body is, the less it reflects and the more it absorbs. And since it has been found that the emissive power of a body is directly proportional to its absorbtivity, a body for which the reflectivity is zero and the absorbtivity 100 % is the best possible radiator. Because such a body would absorb all the incident radiation is therefore known as a “Blackbody”. By the same token, a less efficient radiator is known as a “Grey body”. It is interesting to note the comparison to the black holes found in space by astronomers that take all matter including light into the hole and appears to return nothing but a huge gravity field results which is invisible.

The colour temperature of various sources

- A candle flame is approximately 1750 degrees Kelvin.
- Tungsten domestic bulbs are 2500 K to 2800 degrees K.
- Professional Tungsten bulbs are 3200 degrees K.
- Professional Quartz Halogen bulbs are 3200 degrees K.
- “Argophot,” “Nitraphot or photo pearl” is 3200 degrees K (Life = 100 hours).
- Warm white fluorescent bulbs are 3500 degrees K.
- “Cool white” Fluorescent bulbs are 4500 degrees K.
- Note all the above bulbs are for 240 Volt AC or DC operation, colour temperature is quoted at this voltage.
- White LED’ 6500 degrees K up to 8500 degrees K, depending on make or manufacturer
- M28 Flash lamp is 4800 degrees K
- Average noon sunlight is 5000 degrees K. Midday sun plus sky is approximately 6000 K
- Daylight with a heavily overcast sky is about 6500 K. Hazy blue sky reads about 9000 K.
- Clear Blue Sky. This depends on what part of the world you are in, 13000 K up to 29000 degrees Kelvin. And also how high above sea level, ascend for ascending colour temperature!
- Film stock Type Daylight. Filter 80 C+82 at 3600 K Bluish
- Film stock type A. Filter 85+81 or 85 B at 6600 K Yellowish
- Film stock type B is not generally available.

Filters used to correct tungsten light to daylight film stock should be assessed only by use of the correct film stock information and the recommendations for its use with the details of the filters to be used. In other words do not rely on general comments as to which filters are best. Always use the correct filters appropriate to the film stock selected. Professional Kodak film is quite different to Professional Fujifilm.

Photometric units of measurement

1. Definition of the units

To evaluate lighting, we either make measurements of the luminance of different points in the subject to be filmed or televised or, more simply, measure the incident light with a meter.

A clear distinction must always be made between “Illumination” and “Luminance”.

(A) “Illumination” corresponds to the quantity of light received onto a unit surface area.

(B) “Luminance” corresponds to the quantity of light emitted from a unit surface area in a unit of solid angle.

Illumination is expressed in “LUX” or “Foot Candles”; -

One lux (symbol is lx) represents the illumination of an area of one square metre with a flux of one lumen

One Foot-candle (symbol is fc or ft.c) represents the illumination of an area of one square foot with a flux of one lumen.

By calculation the foot-candle is a unit 10.76 times larger than the lux.

Luminances are expressed in “Apostilbs”, “Nits” or “Foot lamberts”.

The nit (symbol is nt) corresponds to the luminance of a source having a luminous intensity of one “candela” per square metre of apparent area being the projected area of the radiating surface normal to the direction of the light.

The “Apostilb” (symbol is asb) is equal to 1 over π nit

The foot-lambert (symbol is fL) is equal to 3.426 nits or 10.76 apostilbs.

2. Lamberts Law

Generally speaking, a surface receiving a given amount of illumination from incident light (expressed in lux or foot-candles) becomes itself a source of light (as a reflective surface) whose luminance is expressed in “nits”, “apostilbs” and Foot-lamberts.

The relation between the illumination figure and the luminance figure is a function of the reflective index of the surface and the direction (and angle) of the reflected light.

This relationship is very simple for the case of a perfectly reflecting surface, obeying Lamberts Law.

Under these conditions: -

- The illumination in lux and the luminance in apostilbs are expressed by the same number.
- The illumination in foot-candles and the luminance in foot-lamberts are expressed by the same number.

For a perfect reflector: -

- Incident illumination = Luminance, Lux = apostilb, { π lux = nit}.
- foot-lamberts = foot-candles.

LED'S (Light emitting Diode's)

The colour of light emitted by these Diode's is determined by the materials used in their construction.

Green light is produced from a (GaP) Gallium Phosphide diode junction.

A Red light from a (AlGaAs) Aluminium Gallium Arsenide diode junction.

And a blue light or (UV) light from a (ZnSe) Zink Selenide diode junctions.

These diode's are actually lasers and have a specific position on the spectral scale and do not produce wide spectral light such as sunlight.

White Led's however do produce a broad spectral light source and use a different approach to their construction, white light is produced by providing a UV source of high intensity to activate a phosphor reflector, this phosphor produces white light in direct proportion to the amount of UV hitting it thus the light output can be controlled from zero to maximum by the application of a DC current through the junction of the diode. The colour temperature remains constant at any light level, the colour is dependent entirely on the mixture of the phosphor used in the construction of the reflector inside the device.

For good safety reasons the construction of the device does not allow any UV light to escape in emission's from the white light source.

The white light is cold and does not radiate heat.

The colour temperatures available are 6500° to 8000° Kelvin depending on the selected source manufacturer. The peak light output for LUXEON devices appears to be at 8000° Kelvin. Single devices and strips of 12 devices, and also rings of six or twelve devices which are made to fit inside each other, are currently available all with a life expectancy of 100,000 hours.

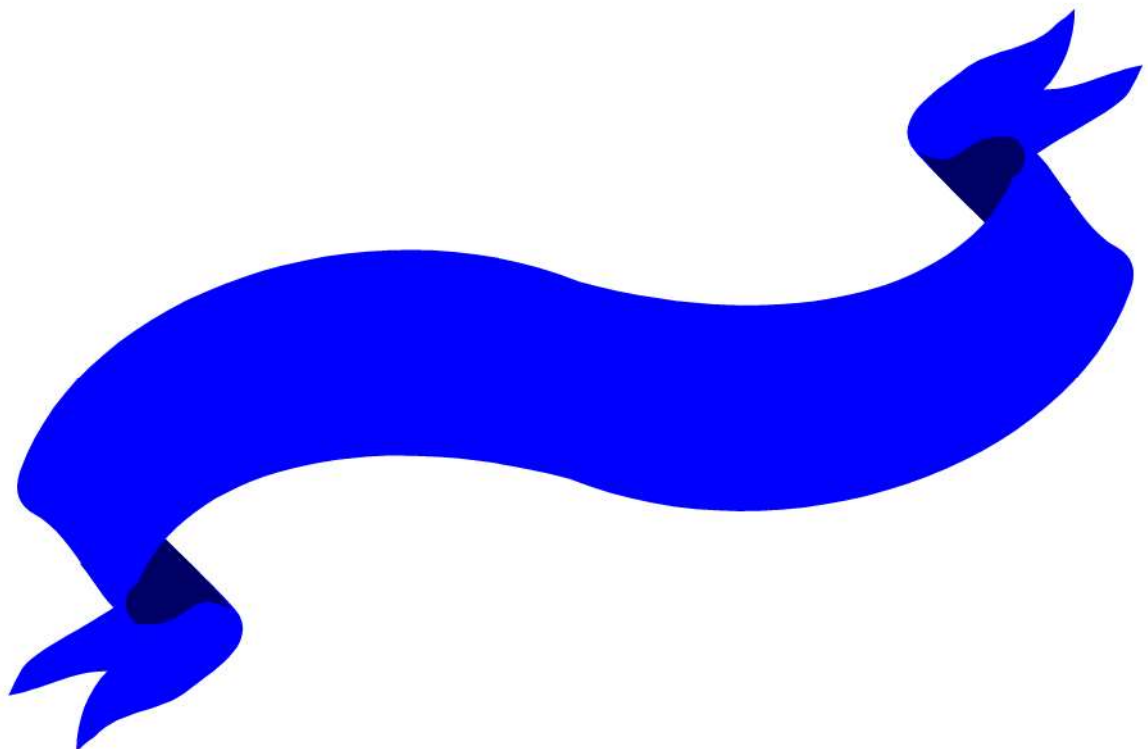

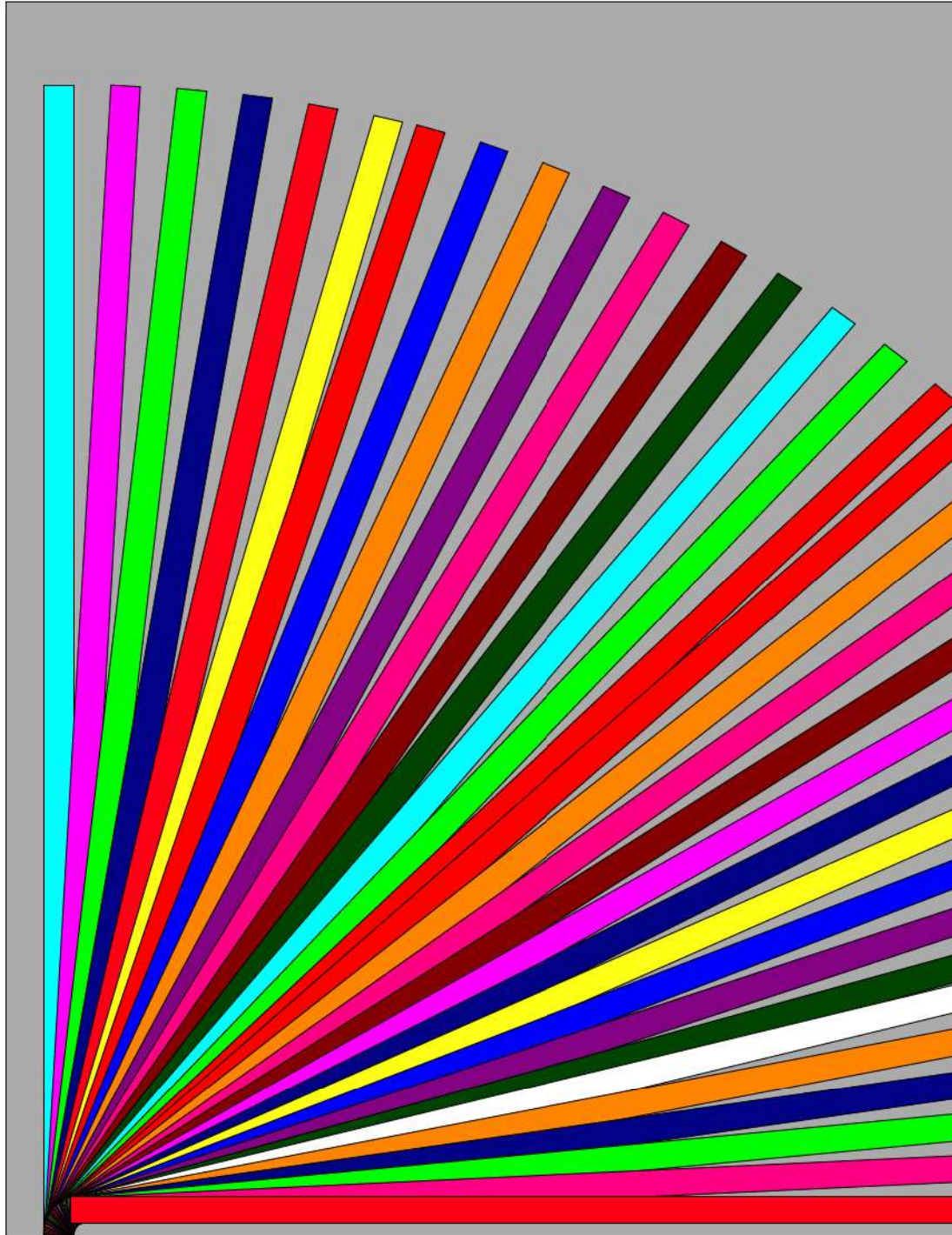

References

- Joseph Flaherty, C.B.S Network operations department Canada.
- Louie Botone, R I P ...A.B.C Television, Thames T.V Teddington UK.
- Thomas Kelly, R.T.E. Dublin, & C.B.S Toronto Canada.
- Ray Knight, A.B.C Television, I.B.A.
- Randal Miles, B.B.C, R.T.E, Strand Electric UK.
- Alan Beal, Film lighting cameraman.
- Terrence Donovan, R I P.... Photographer for “the Sun News paper” at the “T.V.i studios”.(T.V.i. is a trade mark)
- Frank Weeks, Master control engineer T.V.S. Maidstone Kent.
- Alan Tucker-Brown Senior engineer LNN.
- A recommended site to visit: http://www.psps.com/pages_frames/tech_talk/film_and_video_terms.htm

Reference books

- “The Knowledge” Miller Freeman, contains all film and television people and equipment suppliers etc.
- E.B.U. Lighting for television and film.
- Stage Lighting, by Richard Pilbrow.
- C.B.S, Lighting practices in television.
- Film Lighting, by Kris Malkievicz. ISBN 0-671-62271-4
- Claude Sauvageot Photographer. ISBN 0871650819
- Photography a practical handbook by Allan Shriver. ISBN 0861360567
- The Saint Michael photography course by David Kilpatrick. ISBN 1209983
- Learning to light by Roger Hicks and Francis Schultz. ISBN 1 85585 6077

- The Video Maker's Handbook Roland Lewis. A Pan Original Sports and pastimes ISBN 0-330-30033-4.

Author's brief history

- Born 1934
- 1945-1949 Educated at the Fawcett school Brighton Sussex.
- 1949-1950 Gregg Commercial College Brighton Sussex
- 1950-1951 Shoreham Shipbuilding Co Ltd Sussex
- 1951-1952-Fish & Chip shop Manager
- 1952-1955 Ground wireless fitter in the Royal Air Force after the first year I was moved to Egypt for a two year attachment to 305 squadron.
- 1955-1959 M W T Co Chelmsford Essex as TV Test engineer
- 1959-1961 A B C TV & Film Studios Teddington London
- 1961-1966 Telefis Eiran Television studios Donnybrook Dublin Lighting Director and vision engineer.
- 1966-1967 Intertel Television facilities company. Zurich & London, Film & Television Lighting Director and vision engineer.
- 1967-1968 Israel State Television service H O D Film and Television Lighting and vision engineering.
- 1968-1969 Intertel merger with L W T Co and Rank Organisation Working as Engineering manager Lighting & Vision
- 1969-1983 "T V i" Television International Lighting engineering manager
- 1983-1984 Freelance Vision and Lighting engineer Sky TV.
- 1983-1992 T V S Television Technical Operations Co-ordinator, news computer management and Studio special projects.
- 1992-1994 London News Network, Planning and installations Links Engineer Master control
- 1994-1999 TVS, LNN, ITN, Meridian. Freelance Film & Television Lighting, electronics engineering, electronic maintenance, and Links engineer.
- 1999 Retired.

A Brief Glossary of Film and Video Terms

3:2 Pulldown The technique used to convert 24 frames per second film to 30 frames per second video. Every other film frame is held for 3 video fields resulting in a sequence of 3 fields, 2 fields, 3 fields, 2 fields, etc.

4 fsc Composite Digital video as used in D2 and D3 VTRs. Stands for 4 times the Frequency of Subcarrier, which is the sampling rate used.

4:2:2 The sampling ratio used in the D1 (CCIR 601) digital video signal. For every 4 samples of luminance there are 2 samples each of R-Y (Red minus Luminance) and B-Y (Blue minus luminance).

4:4:4 A sampling ratio that has equal amounts of the luminance and both chrominance channels. 16x9 A wide screen television format in which the aspect ratio of the screen is 16 units wide by 9 high as opposed to the 4x3 of normal TV.

A-Frame Edit A video edit which starts on the first frame of the 5 video frame (4 film frame) sequence created when 24 frame film is transferred to 30 frame video (see 3:2 pull-down). The A-frame is the only frame in the sequence where a film frame is completely reproduced on one complete video frame. Here is the full sequence. (The letters correspond to film frames.)

A-frame = video fields 1&2,

B-frame = video fields 1&2&1,

C-frame = video fields 2&1,

D-frame = video fields 2&1&2.

A-Mode Edit An editing method where the footage is assembled in the final scene order. Scene 1, scene 2, ...

Active Picture Area The part of a TV picture that contains actual picture as opposed to sync or other data. Vertically the active picture area is 487 lines for NTSC and 576 lines for PAL. The inactive area is called blanking.

AES/EBU The digital audio standard set by the Audio Engineering Society and European Broadcast Union and used by most forms of digital audio from CDs to D1.

Aliasing Defects in the picture caused by too low a sampling frequency or poor filtering. Usually seen as "jaggies" or stair steps in diagonal lines.

Analog A signal that varies continuously. A digital signal by contrast varies in discreet steps.

Artifact A visual effect caused by an error or limitation in the system.

Anti-aliasing The process of removing aliasing artifacts.

Aspect Ratio The ratio of width to height in a picture. Theater screens generally have an aspect ratio of 1.85 to 1, widescreen TV (16x9) is 1.77 to 1, and normal TV (4x3) is 1.33 to 1.

Auto Assembly An edit in which the off-line edit decision list is loaded into the on-line edit computer and all the edits are assembled automatically with little or no human intervention.

B-Mode Edit An editing method where the footage is assembled in the order it appears on the source reels. Missing scenes are left as black holes to be filled in by a later reel. Requires fewer reel changes and generally results in a faster edit session.

Bandwidth The amount of information that can be passed in a given time. The larger the bandwidth the greater the picture detail.

Bit A single element (1 or 0) of digital information.

Bit Rate The amount of data transported in a given amount of time, usually defined in Mega (Million) bits per second (Mbps). Bit rate is one means used to define the amount of compression used on a video signal. Uncompressed D1 has a bit rate of 270 Mbps. Mpeg 1 has a bit rate to 1.2 Mbps.

Bit Stream A continuous series of bits.

Black Box A term used to describe a piece of equipment dedicated to one specific function, usually involving a form of digital video magic.

Blanking The part of the video signal that contains no picture information.

Broadcast Quality An nebulous term used to describe the output of a manufacturer's product no matter how bad it looks.

Bug An error in a computer program. Also something that bites you on a camping trip.

Burned in Time Code Time code numbers that are superimposed on the picture.

Byte 8 bits. The combination of 8 bits into 1 byte allows each byte to represent 256 possible values. (see Megabyte, Gigabyte, Terrabyte)

CBR Constant Bit Rate. MPEG video compression where the amount of compression does not change.

CCIR 601 The standard for digitizing component video. Also sometimes called D1 after the VTR format that first used this signal.

Chrominance The color part of a video signal.

Component Video A video signal in which the Luminance and Chrominance signals are kept separate. This requires a higher bandwidth, but yields a higher quality picture.

Composite Video The luminance and chrominance signals are combined in an encoder to create the common NTSC, PAL or SECAM video signals. Essentially a form of analog video compression to allow the economical broadcasting of video.

Compositing Layering multiple pictures on top of each other. A cutout or matte holds back the background and allows the foreground picture to appear to be in the original picture.

Compression The process of reducing the size of digital information, usually by throwing out redundant information.

Compression Ratio The ratio of the amount of data in the original video compared to the amount of data in the compressed video. The higher the ratio the greater the compression.

Control Track A signal recorded on video tape to allow the tape to play back at a precise speed in any VTR. Analogous to the sprocket holes on film.

CRT Cathode Ray Tube. The technical name for a picture tube or the scanning tube in a flying spot telecine.

Cutout (see matte)

D1 Digital video tape format using the CCIR 601 standard to record 4:2:2 component video on 19mm tape. Currently the highest quality video tape format generally available. The first digital video tape format, hence D1.

D2 Digital video tape format using the 4fsc method to record composite digital video. Uses 19mm tape and a cassette similar to D1. The second digital video tape format, hence D2.

D3 Digital video tape format using 4fsc composite signals like D2, but recorded on "?" tape. The third digital video tape format...

D4 Doesn't exist, so don't worry about it.

D5 Digital video tape format using CCIR 601, 4:2:2 video. Uses the same cassette as D3. Betcha can guess why it's called D5.

DCT Discrete Cosine Transform. A widely used method of video compression. Also an Ampex CCIR 601 digital VTR using DCT to compress the video before recording it to tape.

Digital A form in which everything is defined by a series of ones and zeros.

Digital Betacam Digital video tape format using the CCIR 601 standard to record 4:2:2 component video in compressed form on "?" tape.

DDR Digital Disk Recorder. A digital video recording device based on high speed computer disk drives. Commonly used as a means to get video into and out from computers.

Digitizing The act of taking analog video and converting it to digital form. In 8 bit digital video there are 256 possible steps between maximum white and minimum black.

DVD Digital Video Disk. A new format for putting full length movies on a 5" CD using MPEG-2 compression for "better than VHS" quality.

DVE Digital Video Effects. A "black box" which digitally manipulates the video to create special effects. Common DVE effects include inverting the picture, shrinking it, moving it around within the frame of another picture, spinning it, and a great many more.

Edge Numbers Numbers printed on the edge of 16 and 35mm motion picture film every foot which allows frames to be easily identified in an edit list.

EDL Edit Decision List. A list of edit decisions made during an edit session and usually saved to floppy disk. Allows an edit to be redone or modified at a later time without having to start all over again.

Field One half of a complete video picture (frame), containing all the odd or even scanning lines of the picture.

Frame One complete video image. There are 30 frames in one second of NTSC video.

HDTV High Definition Television. A TV format capable of displaying on a wider screen (16x9 as opposed to the conventional 4x3) and at higher resolution.

Interlace A process in which the picture is split into two fields by sending all the odd numbered lines to field one and all the even numbered lines to field two. This was necessary in the early days of TV when there was not enough bandwidth to send a complete frame fast enough to create a non-flickering image.

Gigabyte 1 Billion bytes.

ISDN Integrated Services Digital Network. Allows computers to communicate over existing phone lines using a digital telephone network at much higher speeds than are possible with an analog modem.

JPEG Joint Photographic Experts Group. A standard for compressing still pictures.

Keycode A barcode on the edge of motion picture film which allows the film edge numbers to be electronically read and inserted into an edit list. Very useful for generating a negative cut list from a video off-line EDL.

LTC Linear Time Code. Time code recorded on a linear analog track on a video tape.

Letterbox Placing a wide screen image on a conventional TV by placing black bands at the top and bottom of the screen.

Luminance The black and white, or brightness, part of a component video signal.

Matte A black & white high contrast image that suppresses or cuts a hole in the background picture to allow the picture the matte was made from to seamlessly fit in the hole.

Megabyte 1 million bytes.

MPEG Moving Picture Experts Group. A standard for compressing moving pictures.

MPEG 1 Uses a data rate of 1.2 Mbps (Mega Bits per Second), the speed of CD-ROM.

MPEG 2 Supports much higher quality with a data rate (also called bit rate) of from 2 to 10 Mbps. MPEG 2 is the format most favored for video on demand and DVD.

NTSC National Television Standards Committee. The television and video standard in use in the United States. Consists of 525 horizontal lines at a field rate of 60 fields per second.

(Two fields equals one complete Frame). Only 487 of these lines are used for picture. The rest are used for sync or extra information such as VITC and Closed Captioning.

Off-Line Editor A low resolution, usually computer and disk based edit system in which the creative editing decisions can be made at lower cost and often with greater flexibility than in an expensive fully equipped on-line bay.

On-Line Editor An editing system where the actual video master is created. An on-line bay usually consists of an editing computer, video switcher, audio mixer, 1 or more channels of DVE, character generator, and several video tape machines.

PAL Phase Alternating Line. The television and video standard in use in most of Europe. Consists of 625 horizontal lines at a field rate of 50 fields per second. (Two fields equals one complete Frame). Only 576 of these lines are used for picture. The rest are used for sync or extra information such as VITC and Closed Captioning.

PALplus A widescreen (16x9) television standard in use in Europe that is compatible with existing 4x3 TV sets. Non-16x9 TVs show the picture in a letterboxed form.

Pixel Short for Picture Element. The basic unit from which a video or computer picture is made. Essentially a dot with a given color and brightness value. D1 images are 720 pixels wide by 486 high. NTSC images are 640 by 480 pixels.

Resolution The amount of detail in an image. Higher resolution equals more detail. Also used to describe the size of an image, usually in pixels.

Resolution Independent A term to describe equipment that can work in more than resolution. Most equipment can do film resolution or video resolution, but not both. Resolution independent equipment can work in both.

RGB Red, Green, Blue. The primary colors of light. Computers and some analog component devices use separate red, green, and blue color channels to keep the full bandwidth and therefore the highest quality picture.

Sampling Frequency The number of sample measurements taken from an analog signal in a given period of time. These samples are then converted into numerical values stored in bytes to create the digital signal.

TDL Telecine Decision List - A list of the edits made in a telecine session which can be loaded into an off-line editor.

Telecine A device that creates video from motion picture film.

Terrabyte 1 trillion bytes.

Time Code A time reference recorded on tape to identify each frame.

Vapourware Software or hardware that is talked about, but may never actually appear.

VBR Variable Bit Rate. MPEG video compression where the amount of compression can be varied to allow for minimum degradation of the image in scenes that are harder to compress.

VCR Video Cassette Recorder.

VHS Video Home System. ?” consumer video cassette recorder.

VTR Video Tape Recorder.

VITC Vertical Interval Time Code. Timecode stored in the vertical interval of the video signal. Has the advantage of being readable by a VTR in still or jog. Multiple lines of VITC can be added to the signal allowing the encoding of more information than can be stored in normal LTC.



BBC Scanner, Dicky Road

Index

Index

A

Acknowledgments 7
 Addavision 133
 art galleries 125

B

balance 87, 89, 92, 93
 boxing 68

C

catwalk 130, 131
 CCD 61, 62
 Chroma key 51, 52, 53, 54
 colour balance 114
 colour temperature 119, 122
 Continuity 128
 Cyclorama 62

D

Dedications 7
 designer 127, 128, 129, 130
 director 86, 90
 Drama Lighting 85
 Dublin 97
 DVD 139

E

Effects lights 61
 electricians 122, 123

F

filters 134, 135, 136, 137
 Fresnel 86, 87

G

Gobos 59, 61

I

ice skating 124
 inside locations 119
 Introduction 8

K

Kelvin 145, 147, 149
 key light 47, 48, 50, 51, 52, 53
 Knebworth 81, 83

L

Lanterns 72, 82
 LED 62
 Lightflex 137
 Lighting designers 105
 Lighting Plot 48, 50
 Lighting Stencil 39, 41
 Lighting Stencils 39
 lumen 148
 lux 148

M

Maestros 99

O

Objectives of Lighting 9
 Orchestral 97

P

paint 95
 PAR 98
 piano 71, 72, 73, 74

Q

Qualities of light 8

R

Rear screen projection 50

Royal Albert Hall 97, 102, 103

S

spot meter 51, 53, 56

stagehands 128

studio 69, 70, 71, 72, 73, 74, 77, 78, 79, 80, 81

T

Television cameras 121

Television International 112

television studio 106

Television studios 106

W

wrestling 68



Circus TVR Scanner 1964

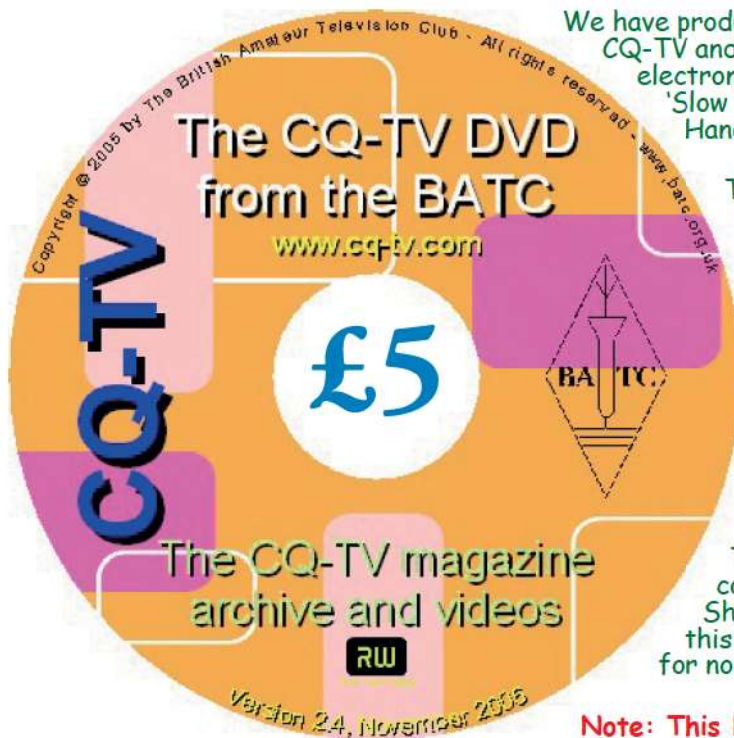

We have produced a DVD containing electronic versions of CQ-TV and the CQ-TV articles index. Also included are electronic versions of our three most recent handbooks, 'Slow Scan Television Explained', 'Amateur Television Handbook' and 'An Introduction to Amateur Television'.

The archive is constantly being updated as more of the old paper issues are converted to electronic format. Currently issues 1 to 134 and 161 to 211 are included along with a few odd ones.

This DVD is updated 4 times a year, to include the current issue of CQ-TV.

The DVD is playable in a standard (domestic) DVD player (and on a PC with a DVD player) and the data files will 'auto-run' when the DVD is put into a PC.

The video section was prepared by Brian Kelly and contains videos from Bletchley Park 1999, one from Shuttleworth 2002 and one from 2004. The cost for this DVD is £5.00 for current members and £10.00 for non-members.

Note: This DVD is supplied on +R media only.

**Cyber membership -
CQ-TV beamed
directly to your
computer, four
times a year,
for only £10**

Visit www.batc.org.uk

